

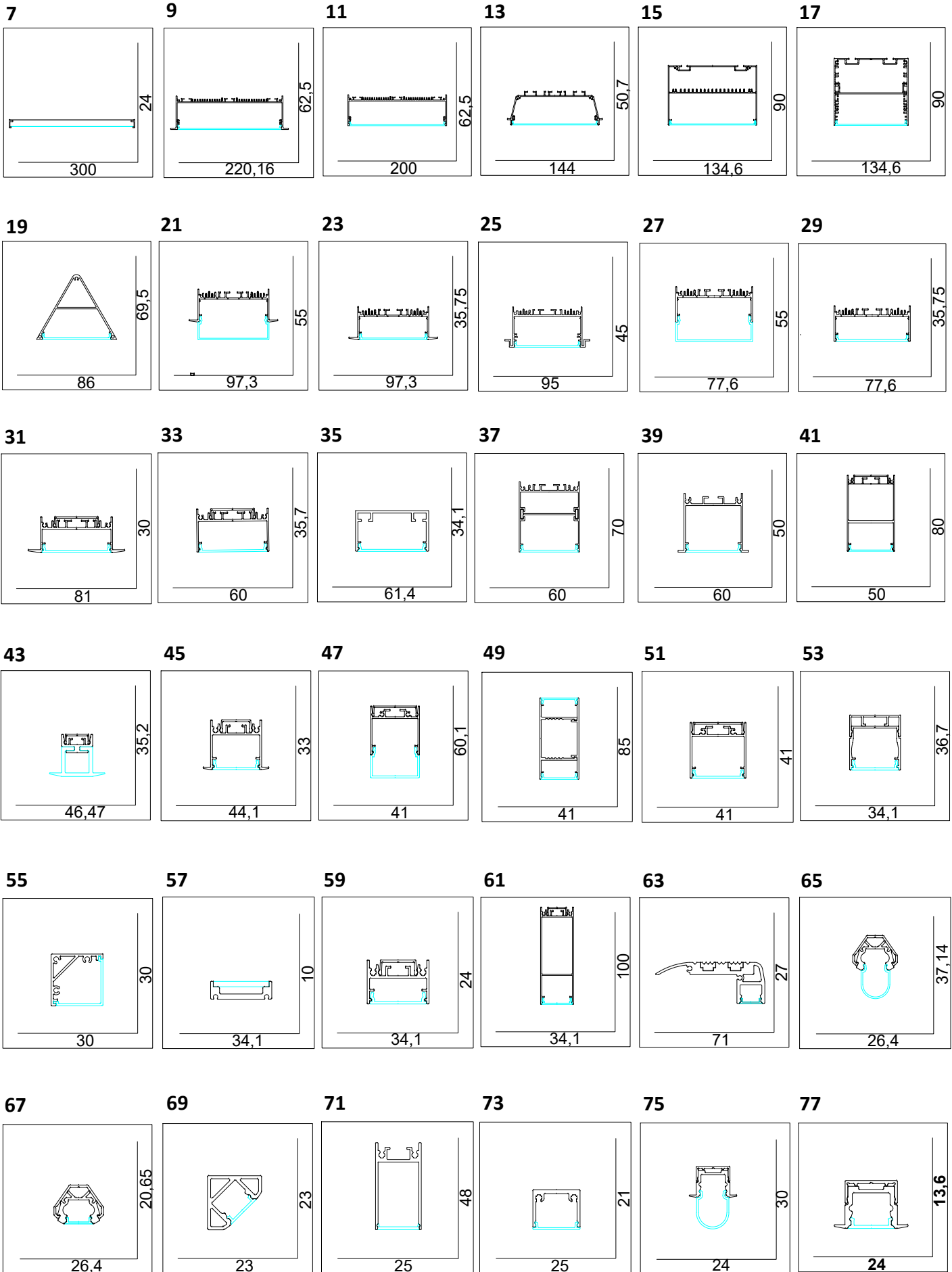

Profilist LED

Decorative & Architectural lighting

INDEX



INDEX

79

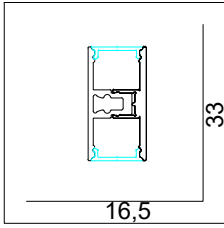

81

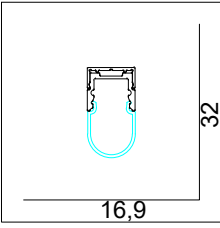

83

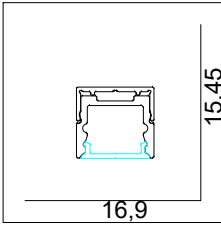

85

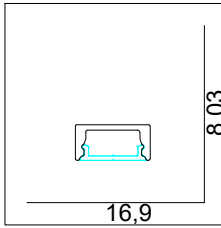

87



89

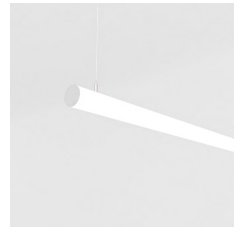

91



93



95



97

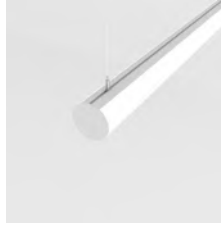

99



101



103



105



107



109



111

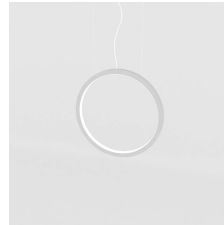

113



115



117



119



121

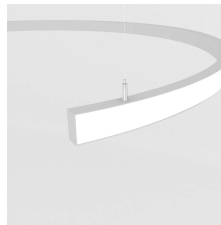

123



125



127



129



131



133



135



137



139



141

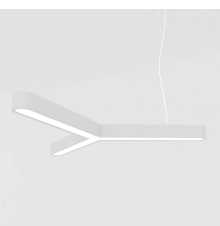

143



145



147

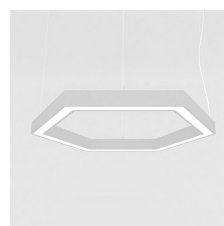

149



INDEX

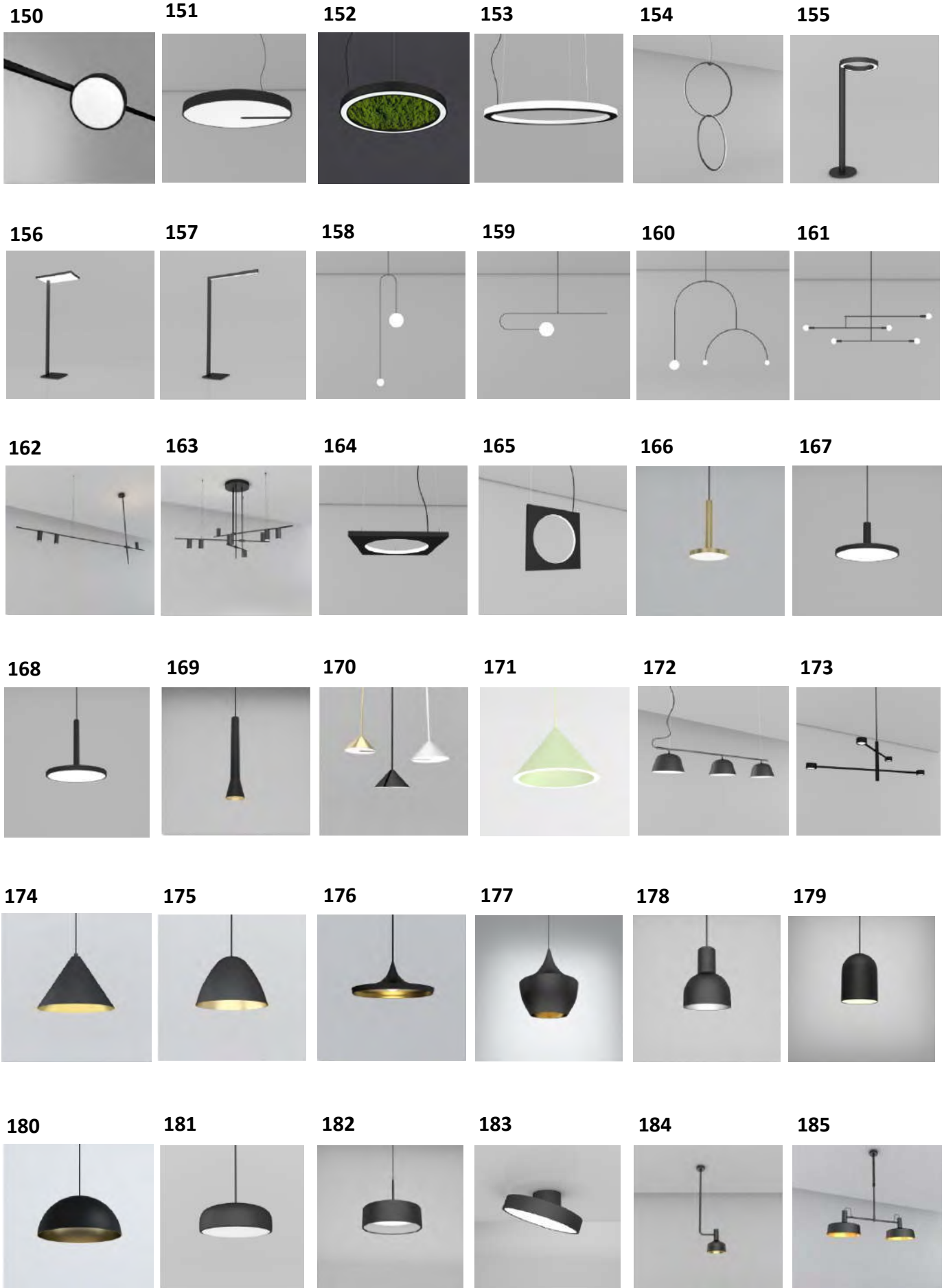

INDEX

186



187



188

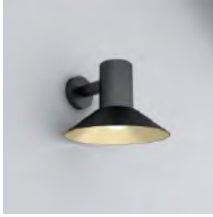

189



190



191



192



193



194



195

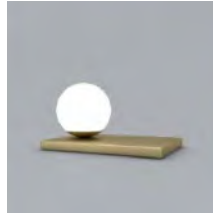

196



197



198



199



200



201



202



203



204



205



206



207



208



209



210



211



212



213



214



215



216



217



218



219



220



221



INDEX

222



223



224



225



226



227



228



229



230



231



232



233



234



235



236



237



238



239



240



241



242



243



244

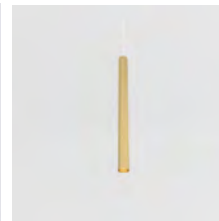

245



246



247



248



249



250

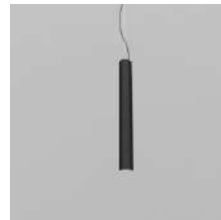

251



252



253



254



255



256



257



INDEX

258



259



260

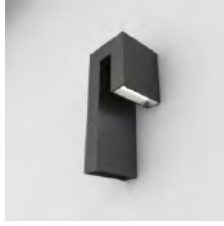

261



PLD 2400

SLIM



Product	
Code	PLD 2400
Name	SLIM
Categories	PROFIL
Subcategory	Linear
	Decorative
Type	Pendant
	Ceiling lamp
Length	< 5 M
Finishing	RAL on request

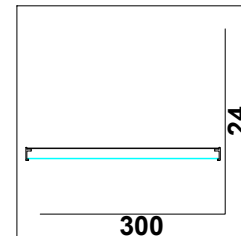

Product Specifications		General Information		Lamp Specifications	
Product Code	PLD.2400	Suspension System	4 wire set	Lamp Type	LED
Body	Extruded Aluminum	Protection	IP40	LED Chip	Samsung
Number of light source	4	Installation	Indoor	Luminous Flux	110 lm/W
Light source color	2700 K → 6000 K	Mounting	Surface mounted/ Pendant	Power	25 W/m
Cap-Base	22 cm	Trimless	N/A	Colour Temperature	2700 K → 6000 K
Light source replacable	Yes	Warranty Period	2 years	Length	2.5 cm → 50 cm
Luminaire light beam	120°			Width	0.8 cm

PLD 2400

SLIM

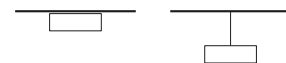

Physical Specifications		Physical Specifications		Options	
Structure	Extruded Aluminum	Finishing	Aluminum anodized/RAL	Length	On request
Reflector	N/A	Weight	-	Finish	RAL on request
Optical Cover	Plexiglass/Microprismatic	Body	Extruded Aluminum	Dimmable	On request
Fixation material	Aluminum/Stainless Steel	Diffuser	Plexiglass/Microprismatic	Trimless	N/A
Length	On request	UV Protection	Yes	Colour Temperature	2700K -> 6000K
Width	300 mm			IP Rate	N/A
Height	24 mm				
Electrical Specifications		Performance		Remarks	
Input Voltage	220-240V	Power	57W/m	Customized length	
Input Frequency	50-60 hz	Luminous Flux	5700lm/m	Angular shapes	
Dimmable	On request	Luminous flux tolerance	15%	RGB version	
Output	24V	Colour Temperature	2700 K -> 6000 K		
IP Rate	IP20-IP67	Colour Rendering Index	≥80		
Power Factor	-	LED Luminaire Efficacy	100 lm/W		
Power	-				

PLD 2001

WIDE

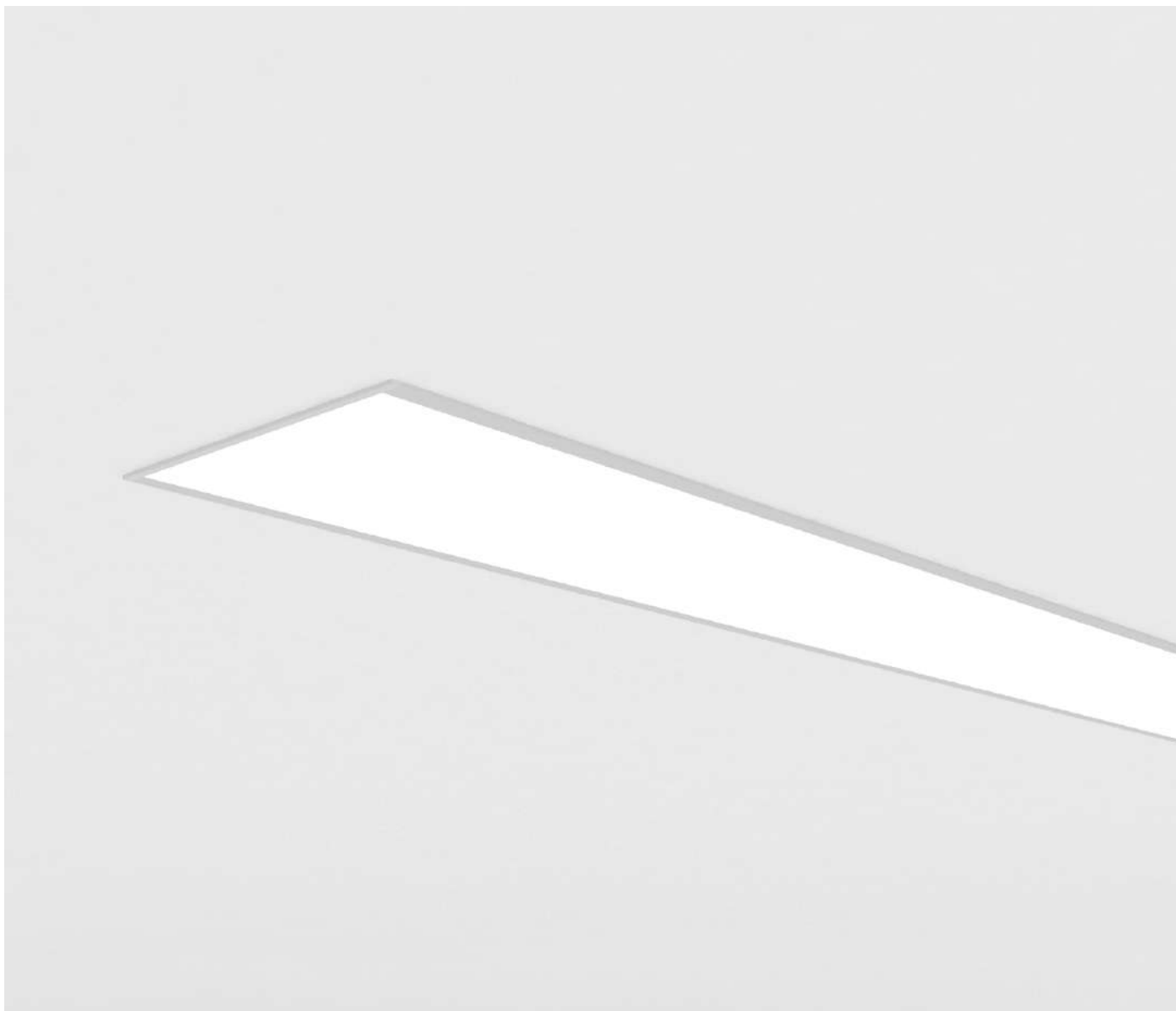

Product	
Code	PLD 2001
Name	WIDE
Categories	PROFIL
Subcategory	Linear
	Decorative
Type	Recessed
Length	< 5 M
Finishing	RAL on request

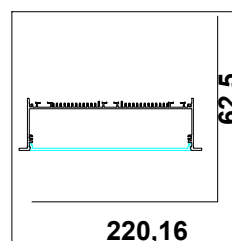

Product Specifications		General Information		Lamp Specifications	
Product Code	PLD.2001	Suspension System	N/A	Lamp Type	LED
Body	Extruded Aluminum	Protection	IP40	LED Chip	Samsung
Number of light source	5	Installation	Indoor	Luminous Flux	110 lm/W
Light source color	2700 K → 6000 K	Mounting	Ceiling recessed	Power	4 W–20 W/m
Cap-Base	N/A	Trimless	N/A	Colour Temperature	2700 K → 6000 K
Light source replacable	Yes	Warranty Period	2 years	Length	2,5 cm → 50 cm
Luminaire light beam	120°			Width	0.8 cm

PLD 2001

WIDE

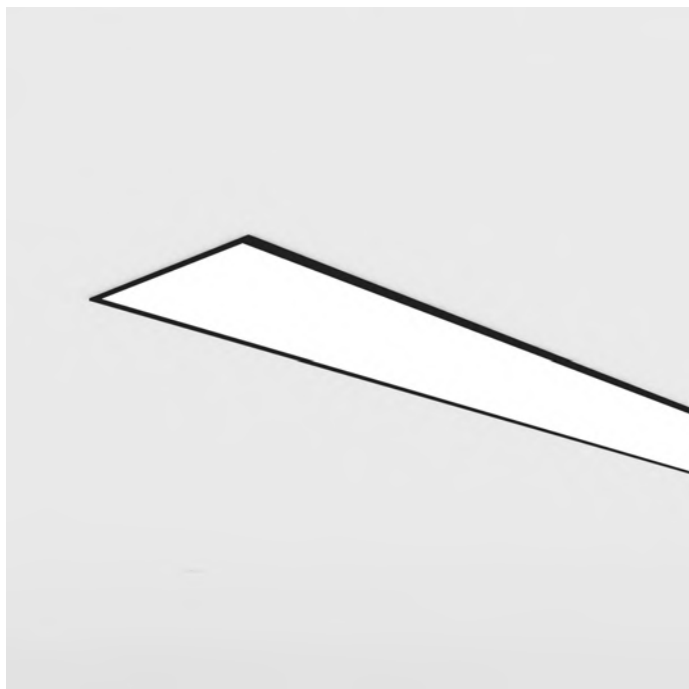
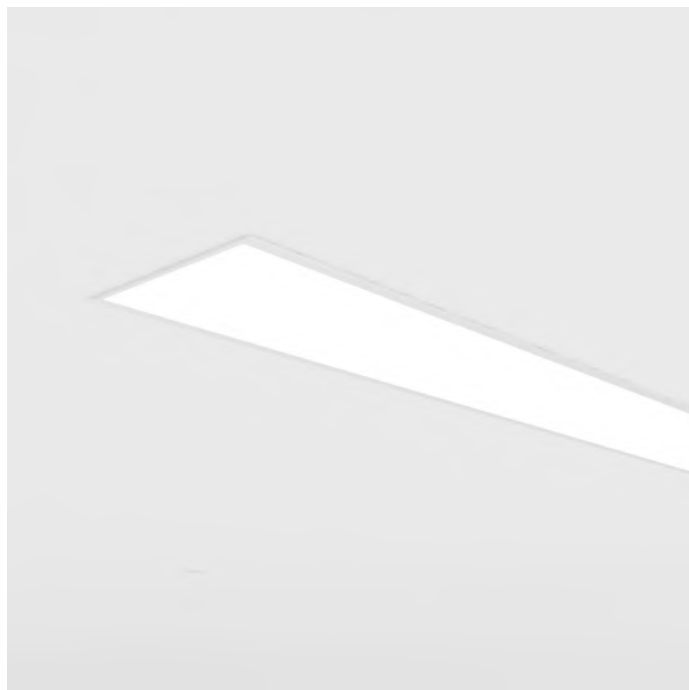

Physical Specifications		Physical Specifications		Options	
Structure	Extruded Aluminum	Finishing	Aluminum anodized/RAL	Length	On request
Reflector	N/A	Weight	-	Finish	RAL on request
Optical Cover	PC Opal/Microprismatic	Body	Extruded Aluminum	Dimmable	On request
Fixation material	Aluminum/Stainless Steel	Diffuser	PC Opal/Microprismatic	Trimless	N/A
Length	On request	UV Protection	Yes	Colour Temperature	2700K -> 6000K
Width	220.16 mm			IP Rate	IP44
Height	62.5 mm				
Electrical Specifications		Performance		Remarks	
Input Voltage	220-240V	Power	20W-100 W/m	Customized length	
Input Frequency	50-60 hz	Luminous Flux	2000 lm-10000 lm/m	Angular shapes	
Dimmable	On request	Luminous flux tolerance	10%	RGB version	
Output	24V	Colour Temperature	2700 K -> 6000 K		
IP Rate	IP20-IP67	Colour Rendering Index	≥80		
Power Factor	-	LED Luminaire Efficacy	100 lm/W		
Power	-				

PLD 2000

BIGGER

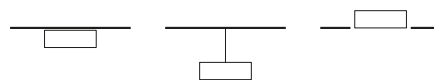

Product	
Code	PLD 2000
Name	BIGGER
Categories	PROFIL
Subcategory	Linear
	Decorative
Type	Pendant
	Ceiling lamp
	Trimless
Lenght	< 5 M
Finishing	RAL on request

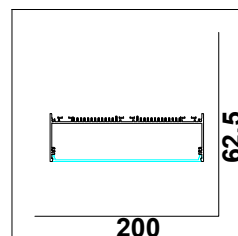

Product Specifications		General Information		Lamp Specifications	
Product Code	PLD.2000	Suspension System	4 wire set	Lamp Type	LED
Body	Extruded Aluminum	Protection	IP40	LED Chip	Samsung
Number of light source	5	Installation	Indoor	Luminous Flux	110 lm/W
Light source color	2700 K → 6000 K	Mounting	Surface mounted/ Pendant	Power	4 W-20 W/m
Cap-Base	22 cm	Trimless	On request	Colour Temperature	2700 K → 6000 K
Light source replacable	Yes	Warranty Period	2 years	Length	2.5 cm → 50 cm
Luminaire light beam	120°			Width	0.8 cm

PLD 2000

BIGGER

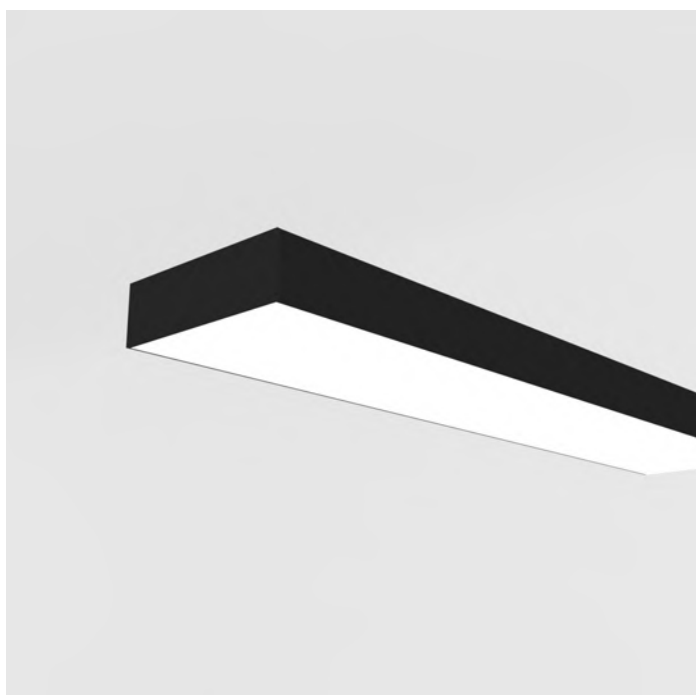
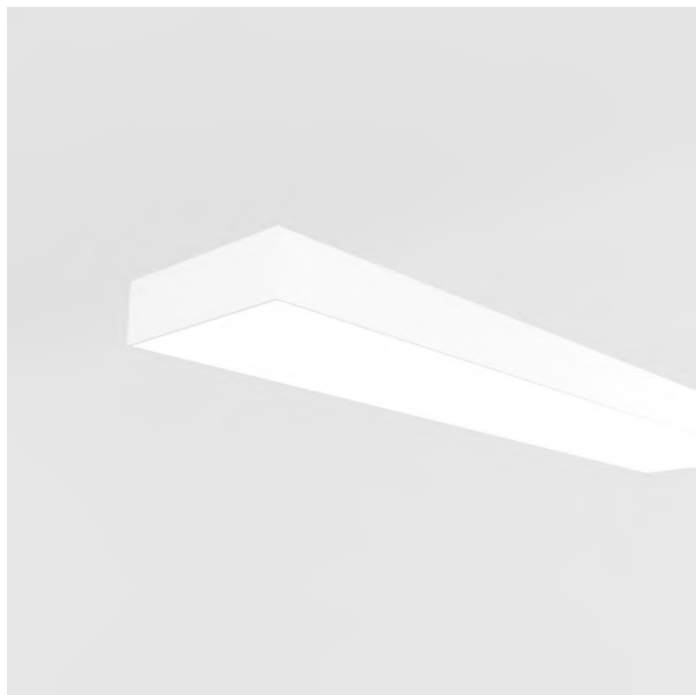
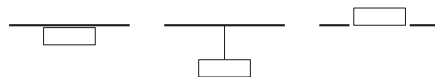

Physical Specifications		Physical Specifications		Options	
Structure	Extruded Aluminum	Finishing	Aluminum anodized/RAL	Length	On request
Reflector	N/A	Weight	-	Finish	RAL on request
Optical Cover	PC Opal/Microprismatic	Body	Extruded Aluminum	Dimmable	On request
Fixation material	Aluminum/Stainless Steel	Diffuser	PC Opal/Microprismatic	Trimless	On request
Length	On request	UV Protection	Yes	Colour Temperature	2700K -> 6000K
Width	200 mm			IP Rate	IP44
Height	62.5 mm				
Electrical Specifications		Performance		Remarks	
Input Voltage	220-240V	Power	20W-100 W/m	Customized length	
Input Frequency	50-60 hz	Luminous Flux	2000 lm-10000 lm/m	Angular shapes	
Dimmable	On request	Luminous flux tolerance	10%	RGB version	
Output	24V	Colour Temperature	2700 K -> 6000 K		
IP Rate	IP20-IP67	Colour Rendering Index	≥80		
Power Factor	-	LED Luminaire Efficacy	100 lm/W		
Power	-				

PLD 1350

CELLER



Product	
Code	PLD 1350
Name	CELLER
Categories	PROFIL
Subcategory	Linear
	Decorative
Type	Recessed
	Armstrong Ceiling
Length	< 5 M
Finishing	RAL on request

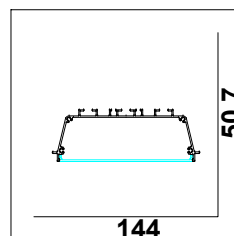

Product Specifications		General Information		Lamp Specifications	
Product Code	PLD 1350	Installation	Drop off	Lamp Type	LED
Body	Extruded Aluminum	Protection	IP40	LED Chip	Samsung
Number of light source	3	Installation	Indoor	Luminous Flux	110 lm/W
Light source color	2700 K → 6000 K	Mounting	Recessed Armstrong Ceiling	Power	4 W-20 W/m
Cap-Base	N/A	Trimless	N/A	Colour Temperature	2700 K → 6000 K
Light source replacable	Yes	Warranty Period	2 years	Length	2.5 cm → 50 cm
Luminaire light beam	120°			Width	0.8 cm

PLD 1350

CELLER



Physical Specifications		Physical Specifications		Options	
Structure	Extruded Aluminum	Finishing	Aluminum anodized/RAL	Length	On request
Reflector	N/A	Weight	–	Finish	RAL on request
Optical Cover	PC Opal/Microprismatic	Body	Extruded Aluminum	Dimmable	On request
Fixation material	Aluminum	Diffuser	PC Opal/Microprismatic	Trimless	N/A
Length	On request	UV Protection	Yes	Colour Temperature	2700K → 6000K
Width	144 mm			IP Rate	IP44
Height	50.7 mm				

Electrical Specifications		Performance		Remarks	
Input Voltage	220–240V	Power	12W–60W/m	Customized length	
Input Frequency	50–60 Hz	Luminous Flux	1200 lm–6000 lm/m	Angular shapes	
Dimmable	On request	Luminous flux tolerance	10%	RGB version	
Output	24V	Colour Temperature	2700 K → 6000 K		
IP Rate	IP20-IP67	Colour Rendering Index	≥80		
Power Factor	–	LED Luminaire Efficacy	100 lm/W		
Power	–				

PLD 1340

GRANDPRY

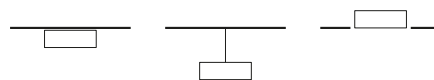

Product	
Code	PLD 1340
Name	GRANDPRY
Categories	PROFIL
Subcategory	Linear
	Decorative
Type	Pendant
	Ceiling lamp
	Trimless
Length	< 5 M
Finishing	RAL on request

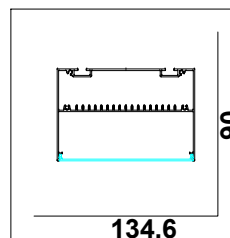

Product Specifications		General Information		Lamp Specifications	
Product Code	PLD 1340	Suspension System	4 wire set	Lamp Type	LED
Body	Extruded Aluminum	Protection	IP40	LED Chip	Samsung
Number of light source	3	Installation	Indoor	Luminous Flux	110 lm/W
Light source color	2700 K → 6000 K	Mounting	Surface mounted/ Pendant	Power	4 W-20 W/m
Cap-Base	6 cm	Trimless	On request	Colour Temperature	2700 K → 6000 K
Light source replacable	Yes	Warranty Period	2 years	Length	2.5 cm → 50 cm
Luminaire light beam	120°			Width	0.8 cm

PLD 1340

GRANDPRY

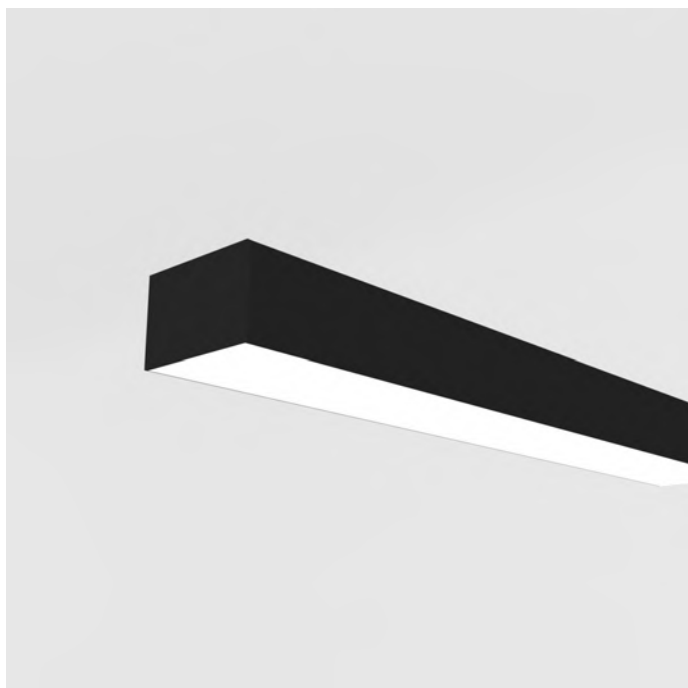
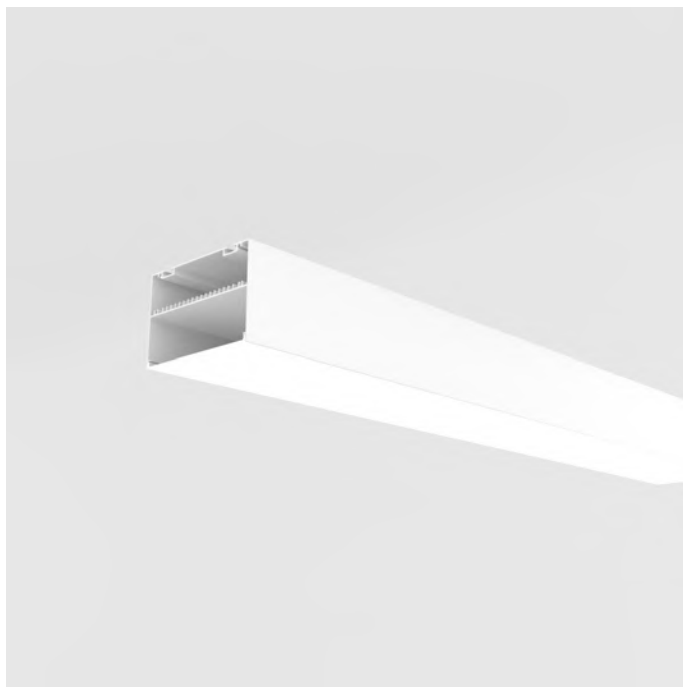
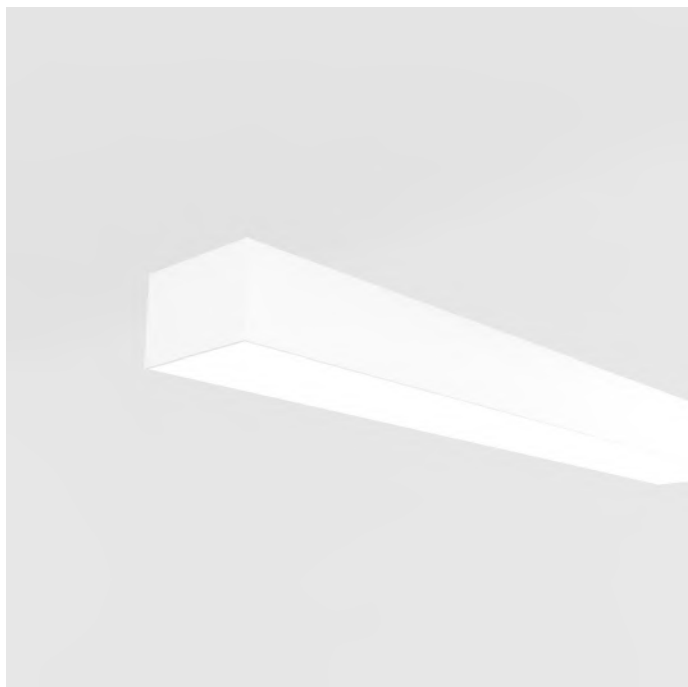
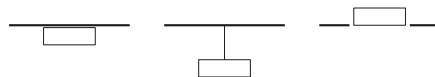

Physical Specifications		Physical Specifications		Options	
Structure	Extruded Aluminum	Finishing	Aluminum anodized/RAL	Length	On request
Reflector	N/A	Weight	-	Finish	RAL on request
Optical Cover	PC Opal/Microprismatic	Body	Extruded Aluminum	Dimmable	On request
Fixation material	Aluminum/Stainless Steel	Diffuser	PC Opal/Microprismatic	Trimless	On request
Length	On request	UV Protection	Yes	Colour Temperature	2700K -> 6000K
Width	134.6 mm			IP Rate	IP44
Height	90 mm				
Electrical Specifications		Performance		Remarks	
Input Voltage	220-240V	Power	12W-60 W/m	Customized length	
Input Frequency	50-60 hz	Luminous Flux	1200 lm-6000 lm/m	Angular shapes	
Dimmable	On request	Luminous flux tolerance	10%	RGB version	
Output	24V	Colour Temperature	2700 K -> 6000 K		
IP Rate	IP20-IP67	Colour Rendering Index	≥80		
Power Factor	-	LED Luminaire Efficacy	100 lm/W		
Power	-				

PLD 1000

ARGO

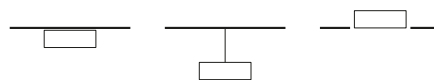

Product	
Code	PLD 1000
Name	ARGO
Categories	PROFIL
Subcategory	Linear
	Decorative
Type	Pendant
	Ceiling lamp
	Trimless
Length	< 5 M
Finishing	RAL on request

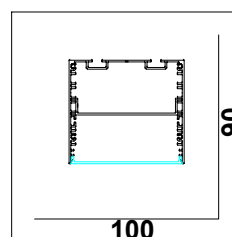

Product Specifications	General Information	Lamp Specifications			
Product Code	PLD 1000	Suspension System	4 wire set	Lamp Type	LED
Body	Extruded Aluminum	Protection	IP40	LED Chip	Samsung
Number of light source	2	Installation	Indoor	Luminous Flux	110 lm/W
Light source color	2700 K → 6000 K	Mounting	Surface mounted/ Pendant	Power	4 W-20 W/m
Cap-Base	6 cm	Trimless	On request	Colour Temperature	2700 K → 6000 K
Light source replacable	Yes	Warranty Period	2 years	Length	2.5 cm → 50 cm
Luminaire light beam	120°			Width	0.8 cm

PLD 1000

ARGO

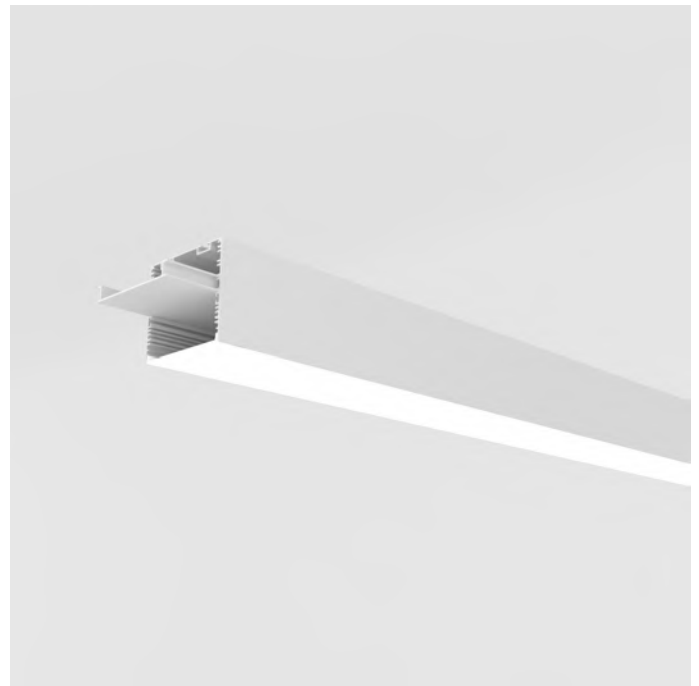
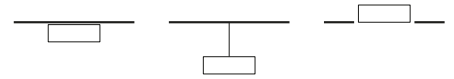

Physical Specifications		Physical Specifications		Options	
Structure	Extruded Aluminum	Finishing	Aluminum anodized/RAL	Length	On request
Reflector	N/A	Weight	-	Finish	RAL on request
Optical Cover	PC Opal/Microprismatic	Body	Extruded Aluminum	Dimmable	On request
Fixation material	Aluminum/Stainless Steel	Diffuser	PC Opal/Microprismatic	Trimless	On request
Length	On request	UV Protection	Yes	Colour Temperature	2700K → 6000K
Width	100 mm			IP Rate	IP44
Height	90 mm				

Electrical Specifications		Performance		Remarks	
Input Voltage	220-240V	Power	8W-40W/m	Customized length	
Input Frequency	50-60 hz	Luminous Flux	800 lm-4000 lm/m	Angular shapes	
Dimmable	On request	Luminous flux tolerance	10%	RGB version	
Output	24V	Colour Temperature	2700 K → 6000 K		
IP Rate	IP20-IP67	Colour Rendering Index	≥80		
Power Factor	-	LED Luminaire Efficacy	100 lm/W		
Power	-				

PLD 800

DOA



Product	
Code	PLD 800
Name	DOA
Categories	PROFIL
Subcategory	Linear
	Decorative
Type	Pendant
Length	< 5 M
Finishing	RAL on request

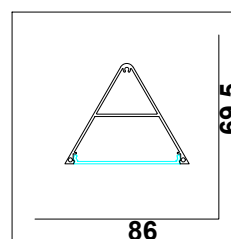

Product Specifications	General Information		Lamp Specifications		
Product Code	PLD 800	Suspension System	2 wire set	Lamp Type	LED
Body	Extruded Aluminum	Protection	IP40	LED Chip	Samsung
Number of light source	2	Installation	Indoor	Luminous Flux	110 lm/W
Light source color	2700 K → 6000 K	Mounting	Pendant	Power	4 W–20 W/m
Cap-Base	15 cm	Trimless	N/A	Colour Temperature	2700 K → 6000 K
Light source replaceable	Yes	Warranty Period	2 years	Length	2.5 cm → 50 cm
Luminaire light beam	120°			Width	0.8 cm

PLD 800

DOA

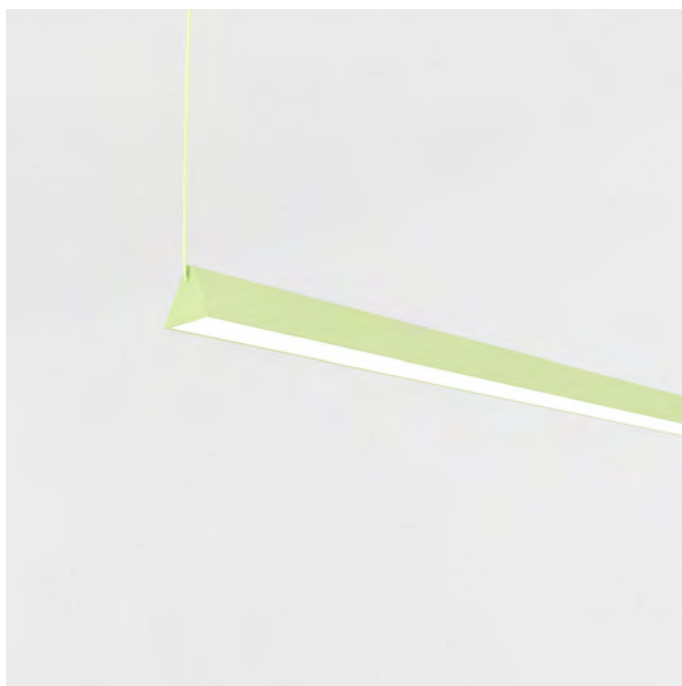

Physical Specifications		Physical Specifications		Options	
Structure	Extruded Aluminum	Finishing	Aluminum anodized/RAL	Length	On request
Reflector	N/A	Weight	-	Finish	RAL on request
Optical Cover	PC Opal/Microprismatic	Body	Extruded Aluminum	Dimmable	On request
Fixation material	Aluminum/Stainless Steel	Diffuser	PC Opal/Microprismatic	Trimless	N/A
Length	On request	UV Protection	Yes	Colour Temperature	2700K → 6000K
Width	86 mm			IP Rate	IP44
Height	69.5 mm				

Electrical Specifications		Performance		Remarks	
Input Voltage	220–240V	Power	8W–40W/m	Customized length	
Input Frequency	50–60 Hz	Luminous Flux	800 lm–4000 lm/m	Angular shapes	
Dimmable	On request	Luminous flux tolerance	10%	RGB version	
Output	24V	Colour Temperature	2700 K → 6000 K		
IP Rate	IP20-IP67	Colour Rendering Index	≥80		
Power Factor	-	LED Luminaire Efficacy	100 lm/W		
Power	-				

PLD 701

TOMI

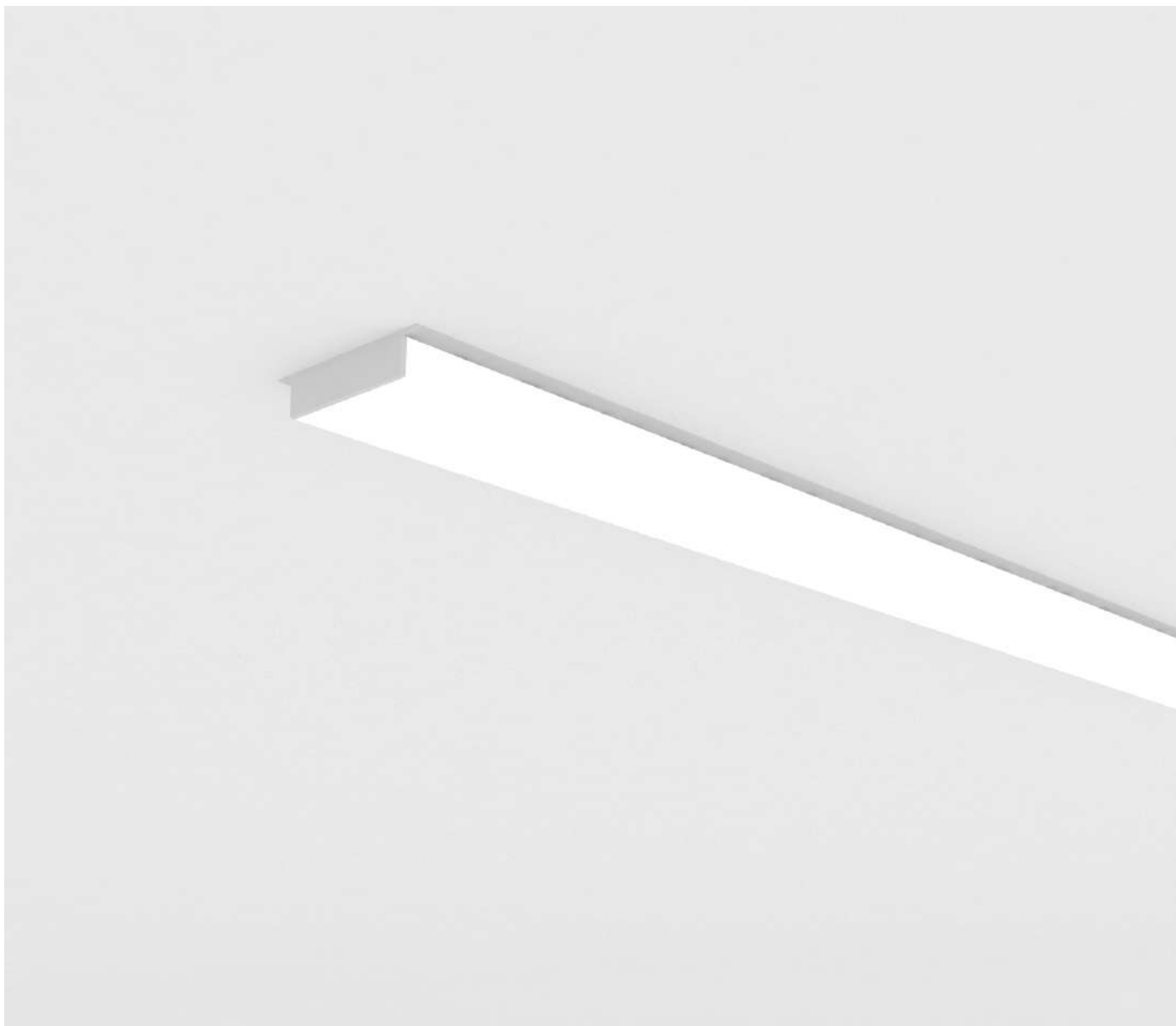

Product	
Code	PLD 701
Name	TOMI
Categories	PROFIL
Subcategory	Linear
	Decorative
Type	Recessed
Length	< 5 M
Finishing	RAL on request

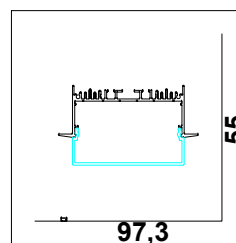

Product Specifications	General Information	Lamp Specifications			
Product Code	PLD 701	Installation	Ceiling Recessed	Lamp Type	LED
Body	Extruded Aluminum	Protection	IP40	LED Chip	Samsung
Number of light source	2	Installation	Indoor	Luminous Flux	110 lm/W
Light source color	2700 K -> 6000 K	Mounting	Recessed with springs	Power	4 W-20 W/m
Cap-Base	N/A	Trimless	N/A	Colour Temperature	2700 K -> 6000 K
Light source replacable	Yes	Warranty Period	2 years	Length	2.5 cm -> 50 cm
Luminaire light beam	120°			Width	0.8 cm

PLD 701

TOMI

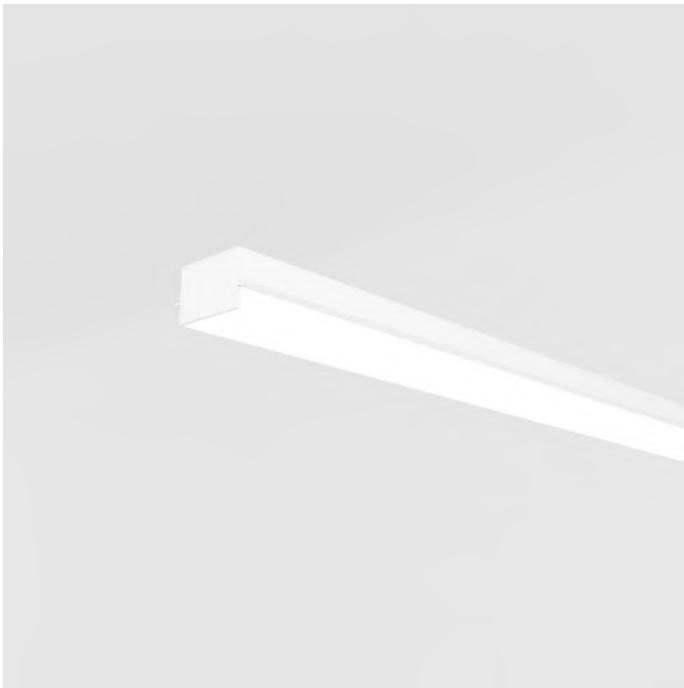

Physical Specifications		Physical Specifications		Options	
Structure	Extruded Aluminum	Finishing	Aluminum anodized/RAL	Length	On request
Reflector	N/A	Weight	–	Finish	RAL on request
Optical Cover	PC Opal	Body	Extruded Aluminum	Dimmable	On request
Fixation material	Aluminum	Diffuser	PC Opal	Trimless	N/A
Length	On request	UV Protection	Yes	Colour Temperature	2700K → 6000K
Width	97.3 mm			IP Rate	IP44
Height	55 mm				
Electrical Specifications		Performance		Remarks	
Input Voltage	220–240V	Power	8W–40W/m	Customized length	
Input Frequency	50–60 Hz	Luminous Flux	800 lm–4000 lm/m	Angular shapes	
Dimmable	On request	Luminous flux tolerance	10%	RGB version	
Output	24V	Colour Temperature	2700 K → 6000 K		
IP Rate	IP20-IP67	Colour Rendering Index	≥80		
Power Factor	–	LED Luminaire Efficacy	100 lm/W		
Power	–				

PLD 700

COMI

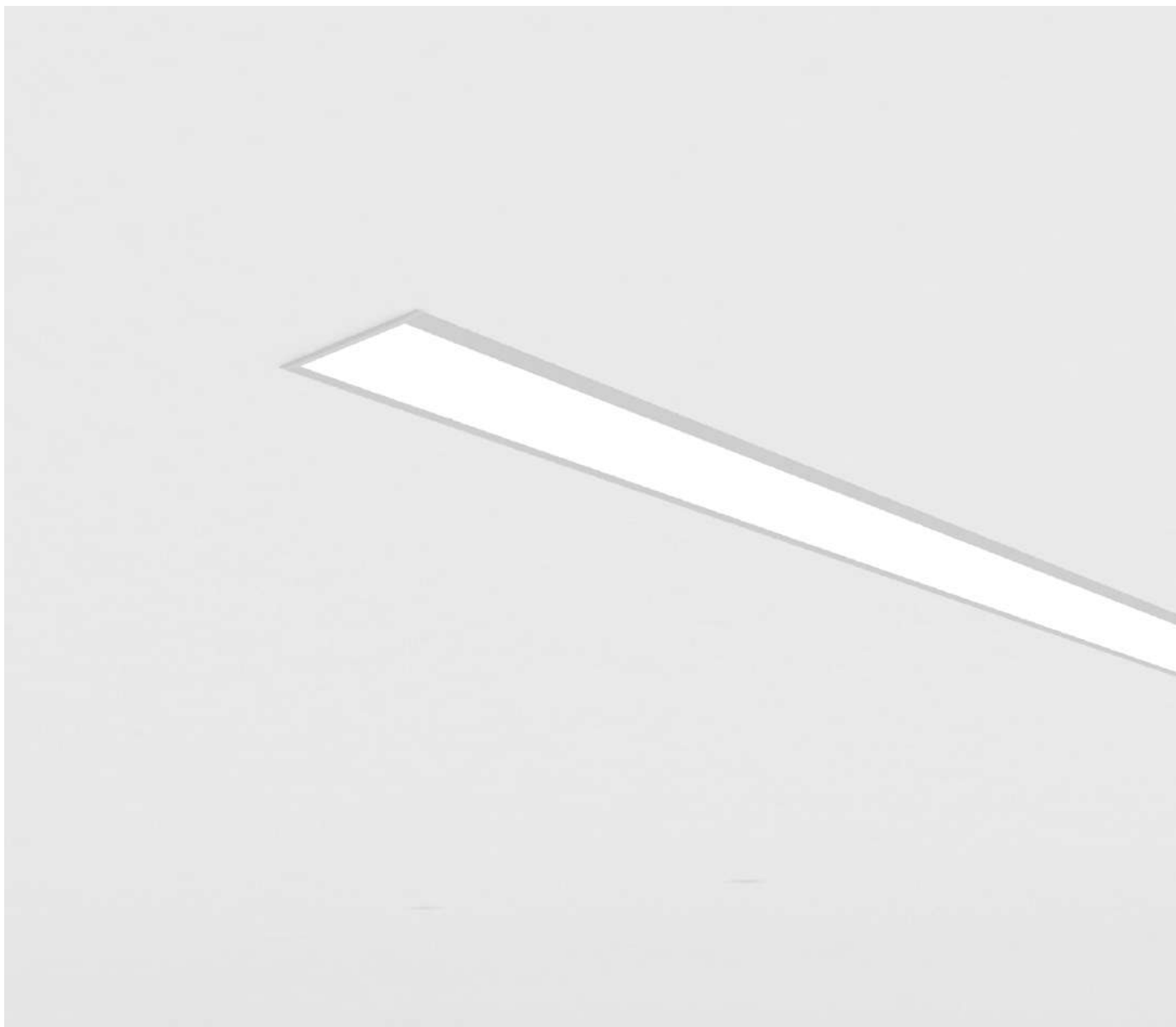

Product	
Code	PLD 700
Name	COMI
Categories	PROFIL
Subcategory	Linear
	Decorative
Type	Recessed
Length	< 5 M
Finishing	RAL on request

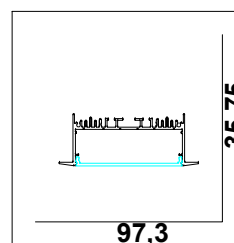

Product Specifications	General Information		Lamp Specifications		
Product Code	PLD 700	Installation	Ceiling Recessed	Lamp Type	LED
Body	Extruded Aluminum	Protection	IP40	LED Chip	Samsung
Number of light source	3	Installation	Indoor	Luminous Flux	110 lm/W
Light source color	2700 K → 6000 K	Mounting	Recessed with springs	Power	4 W–20 W/m
Cap-Base	N/A	Trimless	N/A	Colour Temperature	2700 K → 6000 K
Light source replacable	Yes	Warranty Period	2 years	Length	2.5 cm → 50 cm
Luminaire light beam	120°			Width	0.8 cm

PLD 700

COMI

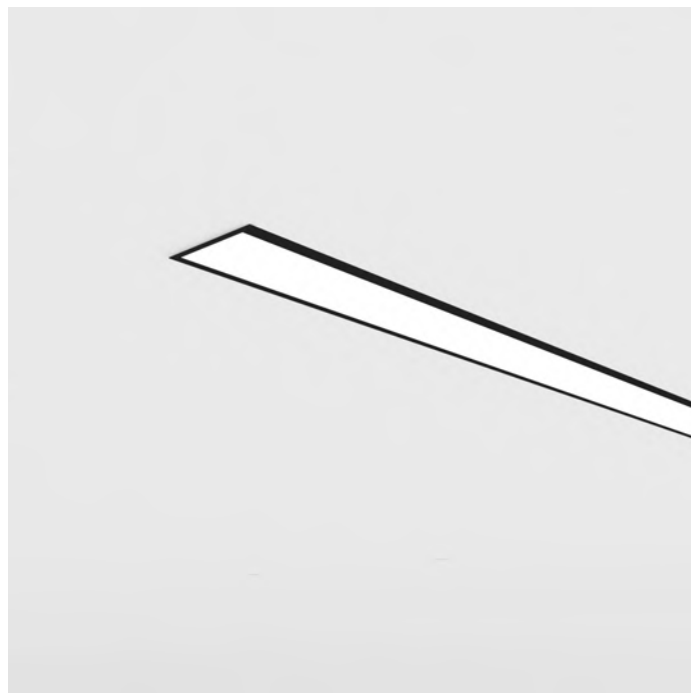
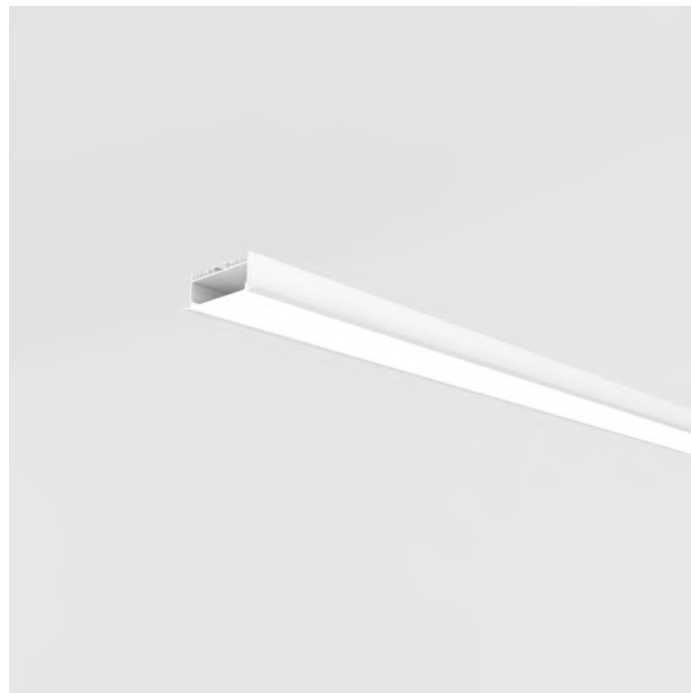
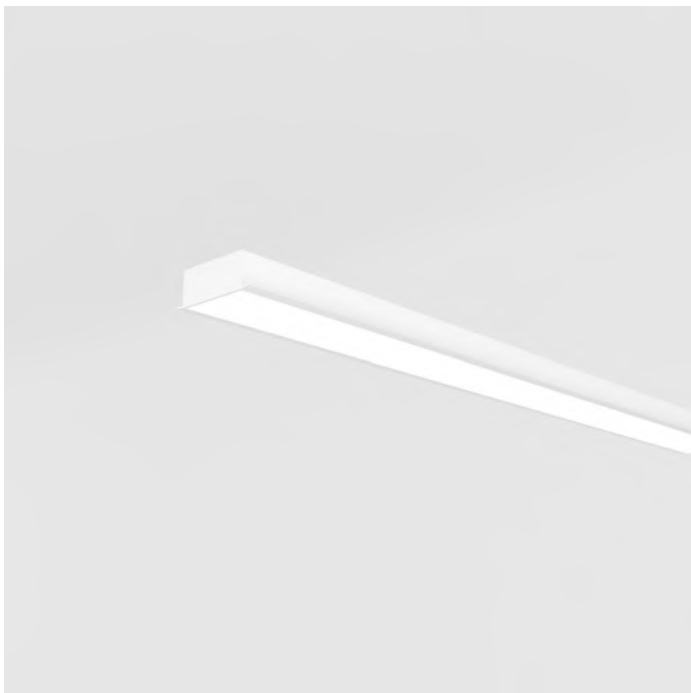

Physical Specifications		Physical Specifications		Options	
Structure	Extruded Aluminum	Finishing	Aluminum anodized/RAL	Length	On request
Reflector	N/A	Weight	–	Finish	RAL on request
Optical Cover	PC Opal/Microprismatic	Body	Extruded Aluminum	Dimmable	On request
Fixation material	Aluminum	Diffuser	PC Opal/Microprismatic	Trimless	N/A
Length	On request	UV Protection	Yes	Colour Temperature	2700K → 6000K
Width	97.3 mm			IP Rate	IP44
Height	35.75 mm				
Electrical Specifications		Performance		Remarks	
Input Voltage	220–240V	Power	12W–45W/m	Customized length	
Input Frequency	50–60 hz	Luminous Flux	1200 lm–4500 lm/m	Angular shapes	
Dimmable	On request	Luminous flux tolerance	10%	RGB version	
Output	24V	Colour Temperature	2700 K → 6000 K		
IP Rate	IP20-IP67	Colour Rendering Index	≥80		
Power Factor	–	LED Luminaire Efficacy	100 lm/W		
Power	–				

PLD 692

ROCA

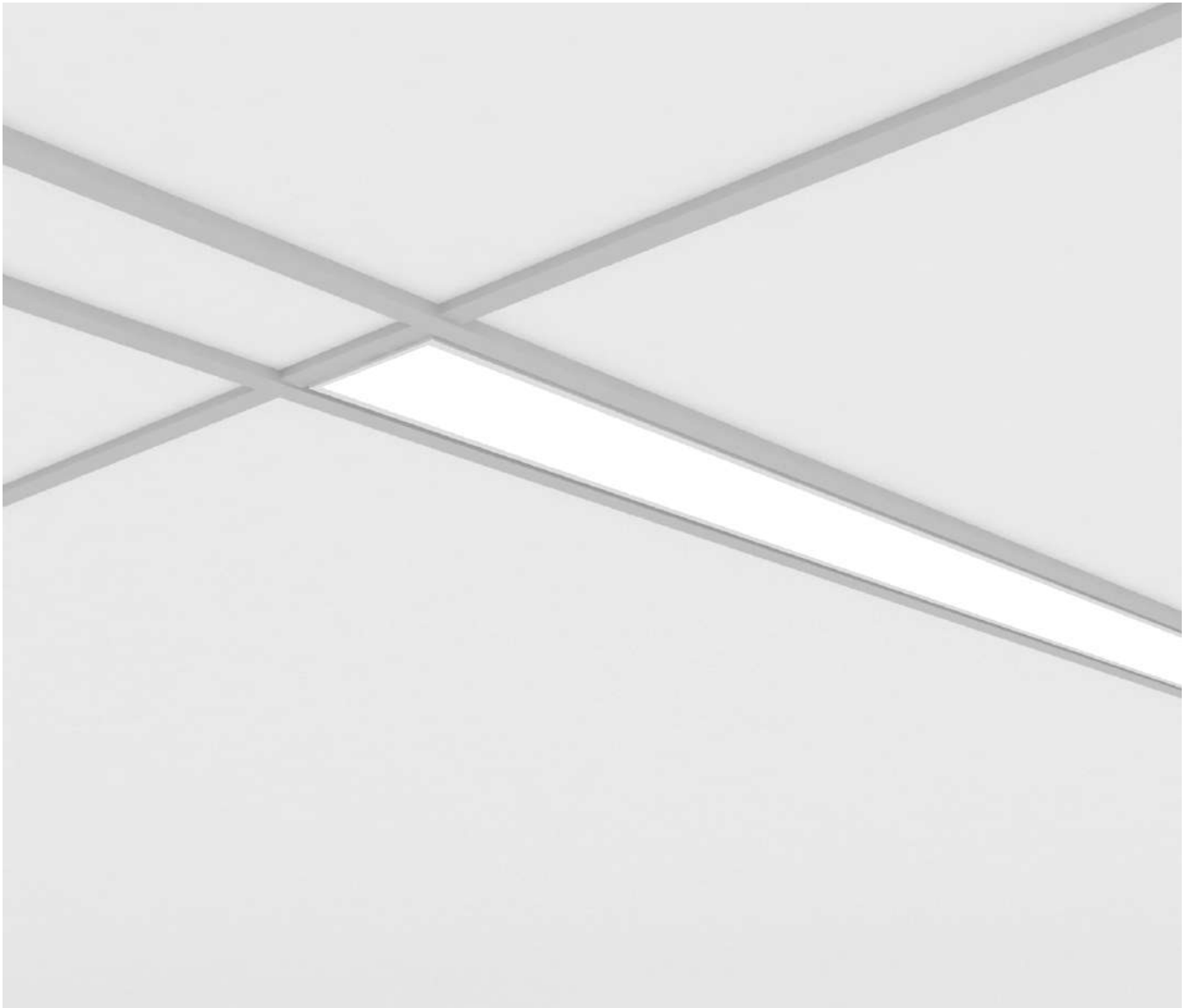

Product	
Code	PLD 692
Name	ROCA
Categories	PROFIL
Subcategory	Linear
	Decorative
Type	Recessed
	Armstrong Ceiling
Lenght	< 5 M
Finishing	RAL on request

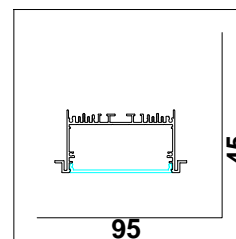

Product Specifications	General Information	Lamp Specifications	
Product Code	PLD 692	Lamp Type	LED
Body	Extruded Aluminum	LED Chip	Samsung
Number of light source	2	Luminous Flux	110 lm/W
Light source color	2700 K → 6000 K	Power	4 W–20 W/m
Cap-Base	N/A	Colour Temperature	2700 K → 6000 K
Light source replacable	Yes	Length	2.5 cm → 50 cm
Luminaire light beam	120°	Width	0.8 cm

PLD 692

ROCA

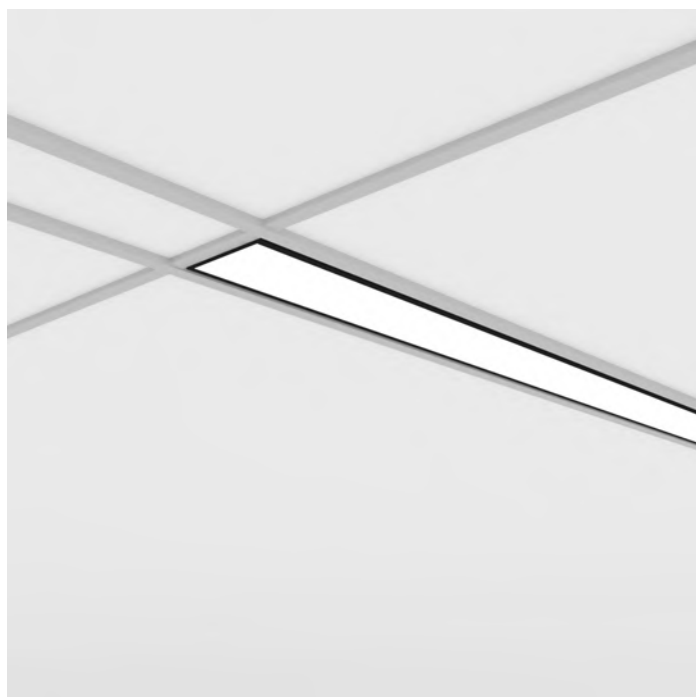

Physical Specifications		Physical Specifications		Options	
Structure	Extruded Aluminum	Finishing	Aluminum anodized/RAL	Length	On request
Reflector	N/A	Weight	-	Finish	RAL on request
Optical Cover	PC Opal/Microprismatic	Body	Extruded Aluminum	Dimmable	On request
Fixation material	Aluminum	Diffuser	PC Opal/Microprismatic	Trimless	N/A
Length	On request	UV Protection	Yes	Colour Temperature	2700K -> 6000K
Width	95 mm			IP Rate	IP44
Height	45mm				
Electrical Specifications		Performance		Remarks	
Input Voltage	220-240V	Power	8W-40W/m	Customized length	
Input Frequency	50-60 hz	Luminous Flux	800 lm-4000 lm/m	Angular shapes	
Dimmable	On request	Luminous flux tolerance	10%	RGB version	
Output	24V	Colour Temperature	2700 K -> 6000 K		
IP Rate	IP20-IP67	Colour Rendering Index	≥80		
Power Factor	-	LED Luminaire Efficacy	100 lm/W		
Power	-				

PLD 691

LOCO

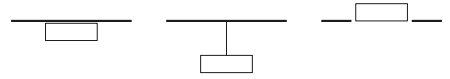

Product	
Code	PLD 691
Name	LOCO
Categories	PROFIL
Subcategory	Linear
	Decorative
Type	Pendant
	Ceiling lamp
	Trimless
Length	< 5 M
Finishing	RAL on request

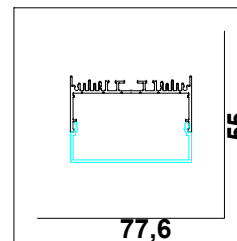

Product Specifications	General Information	Lamp Specifications
Product Code	PLD 691	Suspension System
Body	Extruded Aluminum	Protection
Number of light source	2	Installation
Light source color	2700 K → 6000 K	Mounting
Cap-Base	22 cm	Trimless
Light source replacable	Yes	Warranty Period
Luminaire light beam	120°	
		Lamp Type
		LED Chip
		Luminous Flux
		Power
		Colour Temperature
		Length
		Width

PLD 691

LOCO

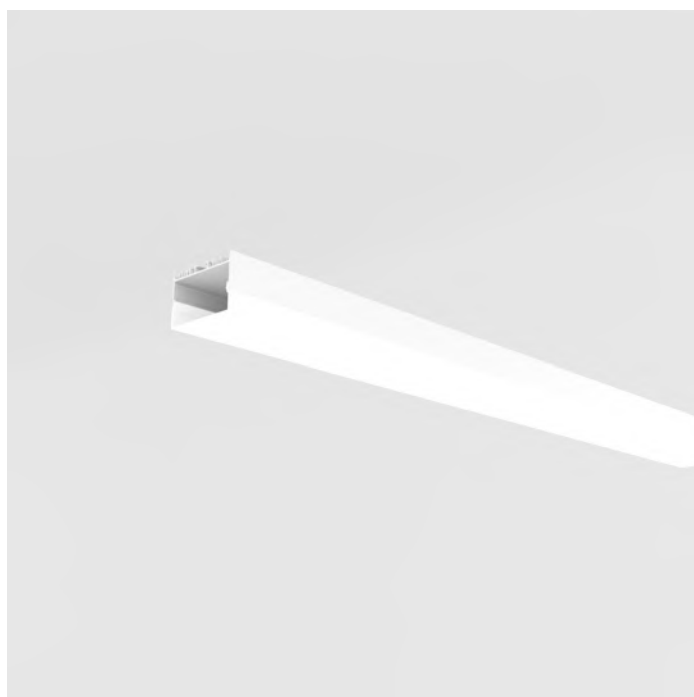
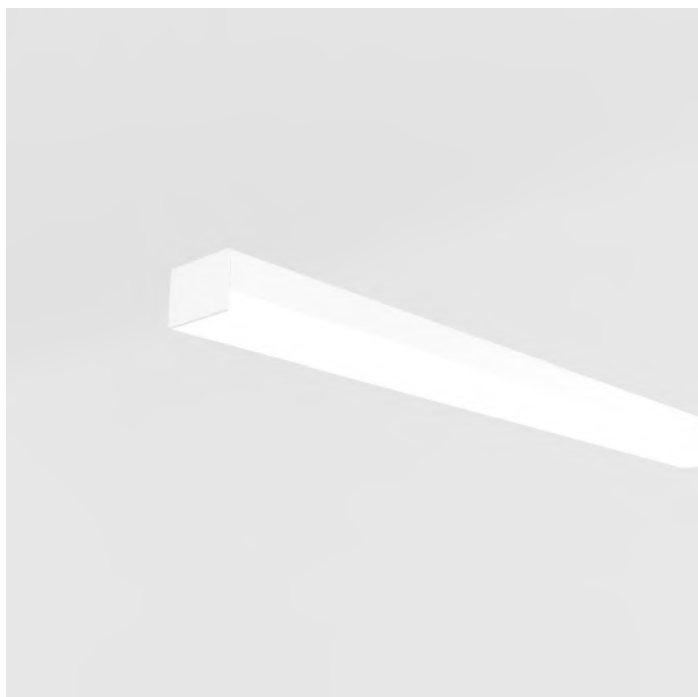
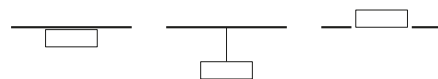

Physical Specifications		Physical Specifications		Options	
Structure	Extruded Aluminum	Finishing	Aluminum anodized/RAL	Length	On request
Reflector	N/A	Weight	-	Finish	RAL on request
Optical Cover	PC Opal	Body	Extruded Aluminum	Dimmable	On request
Fixation material	Aluminum/Stainless Steel	Diffuser	PC Opal	Trimless	On request
Length	On request	UV Protection	Yes	Colour Temperature	2700K → 6000K
Width	77.6 mm			IP Rate	IP44
Height	55 mm				
Electrical Specifications		Performance		Remarks	
Input Voltage	220-240V	Power	8W-40 W/m	Customized length	
Input Frequency	50-60 hz	Luminous Flux	800 lm-4000 lm/m	Angular shapes	
Dimmable	On request	Luminous flux tolerance	10%	RGB version	
Output	24V	Colour Temperature	2700 K → 6000 K		
IP Rate	IP20-IP67	Colour Rendering Index	≥80		
Power Factor	-	LED Luminaire Efficacy	100 lm/W		
Power	-				

PLD 690

PACO

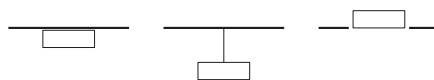

Product	
Code	PLD 690
Name	PACO
Categories	PROFIL
Subcategory	Linear
	Decorative
Type	Pendant
	Ceiling lamp
	Trimless
Length	< 5 M
Finishing	RAL on request

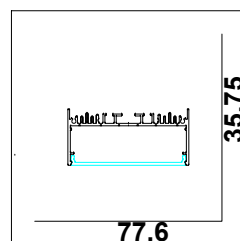

Product Specifications		General Information		Lamp Specifications	
Product Code	PLD 690	Suspension System	2 wire set	Lamp Type	LED
Body	Extruded Aluminum	Protection	IP40	LED Chip	Samsung
Number of light source	3	Installation	Indoor	Luminous Flux	110 lm/W
Light source color	2700 K → 6000 K	Mounting	Surface mounted/ Pendant	Power	4 W–20 W/m
Cap-Base	22 cm	Trimless	On request	Colour Temperature	2700 K → 6000 K
Light source replacable	Yes	Warranty Period	2 years	Length	2.5 cm → 50 cm
Luminaire light beam	120°			Width	0.8 cm

PLD 690

PACO

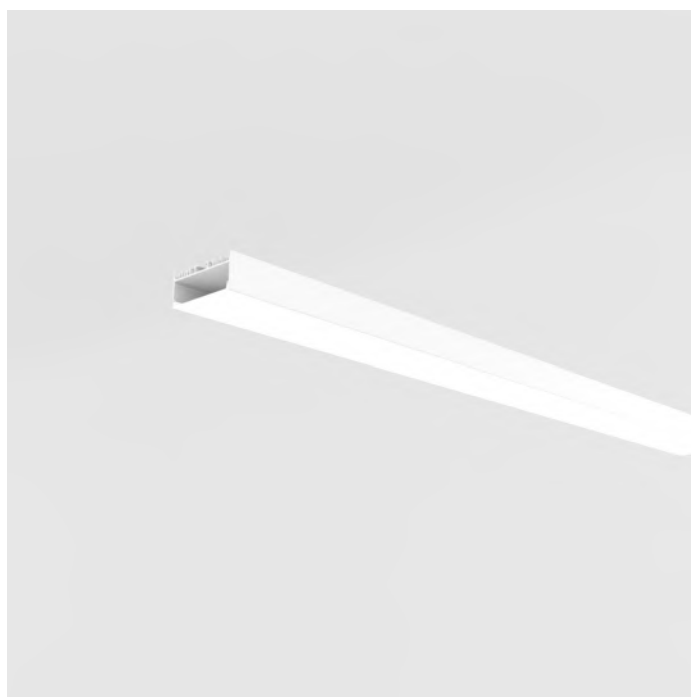
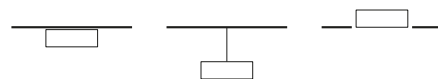

Physical Specifications		Physical Specifications		Options	
Structure	Extruded Aluminum	Finishing	Aluminum anodized/RAL	Length	On request
Reflector	N/A	Weight	-	Finish	RAL on request
Optical Cover	PC Opal/Microprismatic	Body	Extruded Aluminum	Dimmable	On request
Fixation material	Aluminum/Stainless Steel	Diffuser	PC Opal/Microprismatic	Trimless	On request
Length	On request	UV Protection	Yes	Colour Temperature	2700K -> 6000K
Width	77.6 mm			IP Rate	IP44
Height	35.75 mm				

Electrical Specifications		Performance		Remarks	
Input Voltage	220-240V	Power	12W-45W/m	Customized length	
Input Frequency	50-60 hz	Luminous Flux	1200 lm-4500 lm/m	Angular shapes	
Dimmable	On request	Luminous flux tolerance	10%	RGB version	
Output	24V	Colour Temperature	2700 K -> 6000 K		
IP Rate	IP20-IP67	Colour Rendering Index	≥80		
Power Factor	-	LED Luminaire Efficacy	100 lm/W		
Power	-				

PLD 670

BOCA

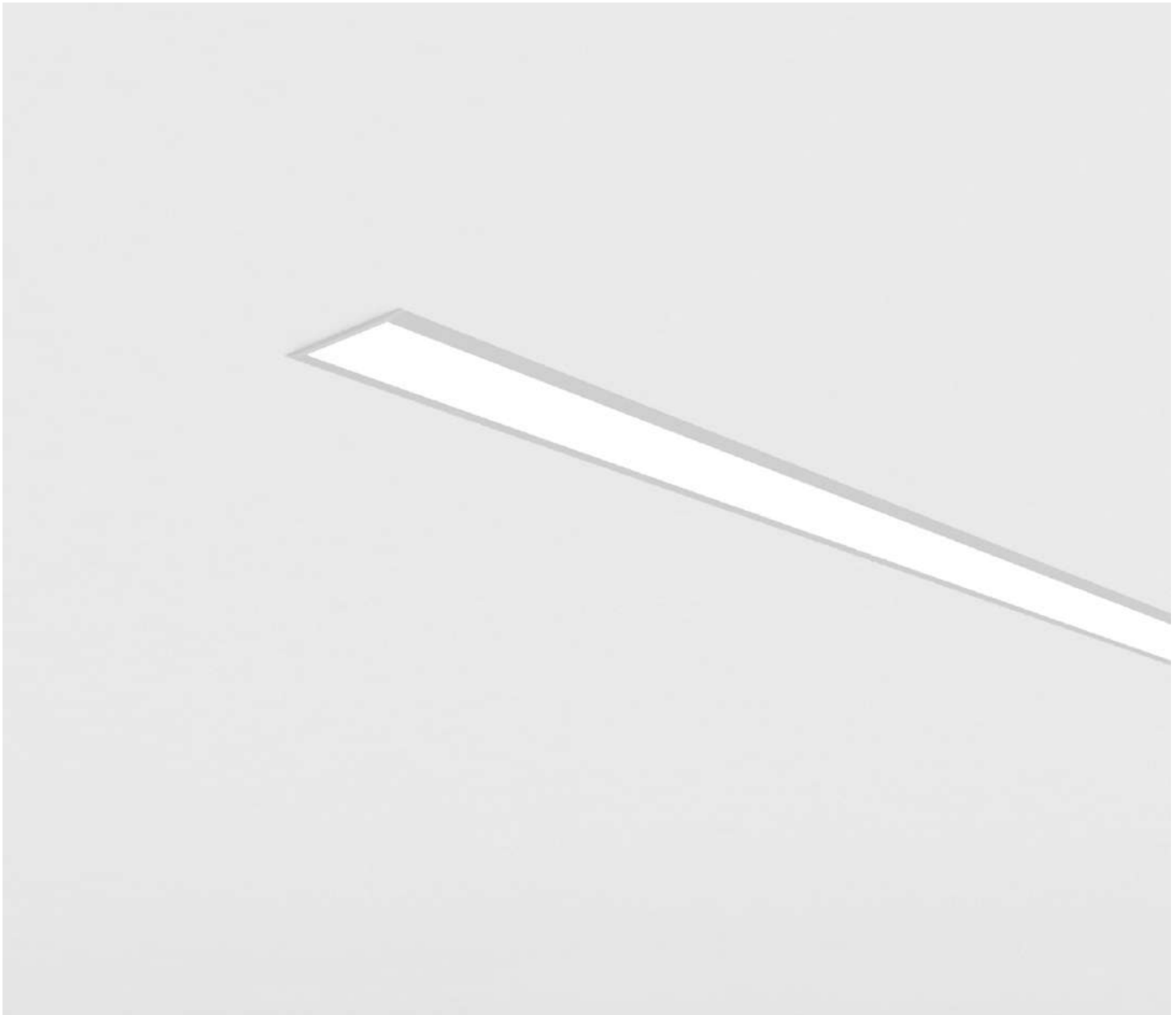

Product	
Code	PLD 670
Name	BOCA
Categories	PROFIL
Subcategory	Linear
	Decorative
Type	Recessed
Length	< 5 M
Finishing	RAL on request

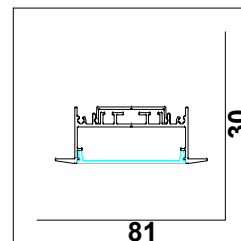

Product Specifications	General Information		Lamp Specifications		
Product Code	PLD 670	Installation	Ceiling Recessed	Lamp Type	LED
Body	Extruded Aluminum	Protection	IP40	LED Chip	Samsung
Number of light source	3	Installation	Indoor	Luminous Flux	110 lm/W
Light source color	2700 K → 6000 K	Mounting	Recessed with springs	Power	4 W–20 W/m
Cap-Base	N/A	Trimless	N/A	Colour Temperature	2700 K → 6000 K
Light source replacable	Yes	Warranty Period	2 years	Length	2.5 cm → 50 cm
Luminaire light beam	120°			Width	0.8 cm

PLD 670

BOCA

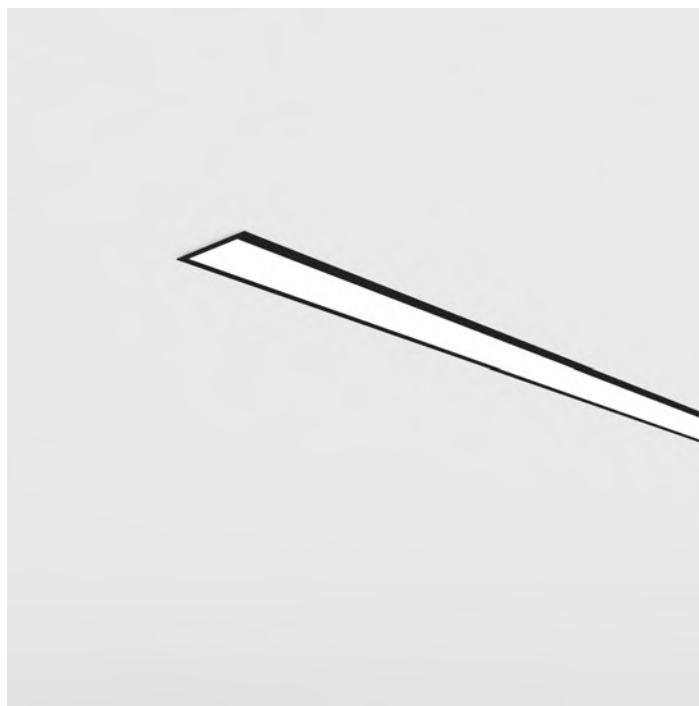
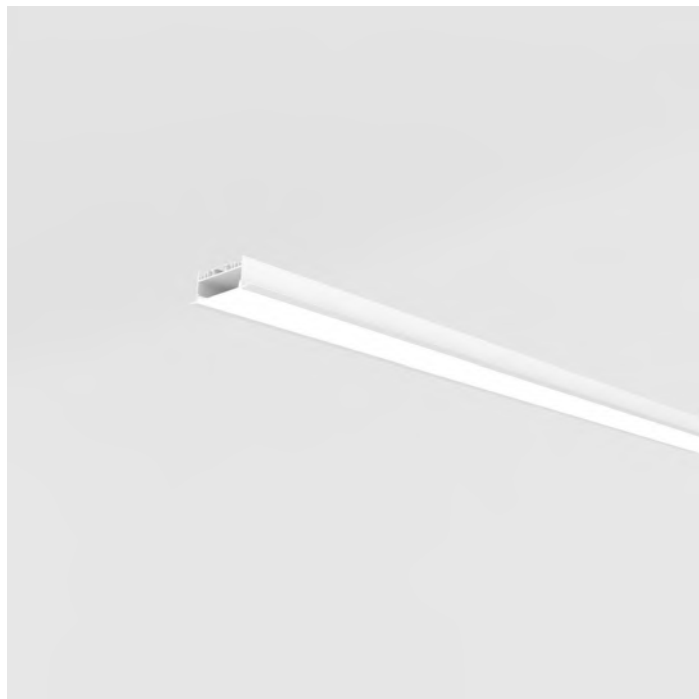
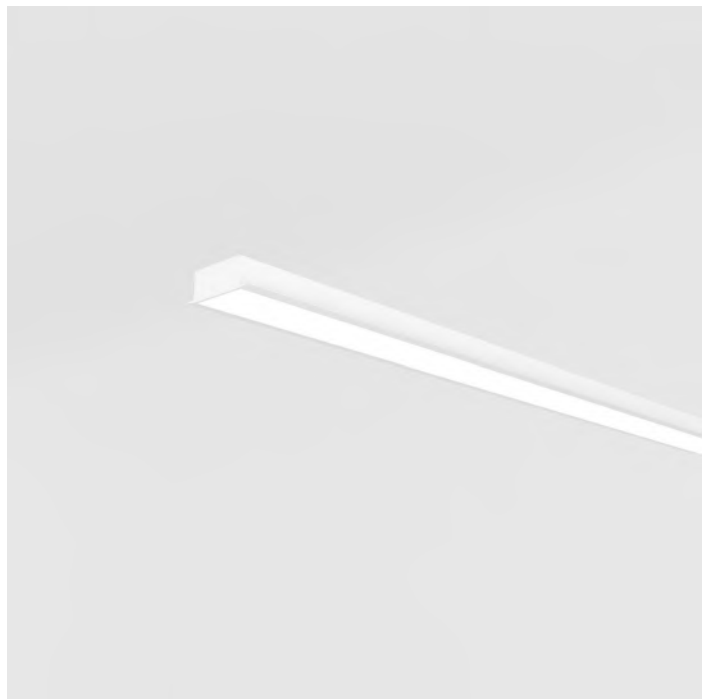

Physical Specifications		Physical Specifications		Options	
Structure	Extruded Aluminum	Finishing	Aluminum anodized/RAL	Length	On request
Reflector	N/A	Weight	–	Finish	RAL on request
Optical Cover	PC Opal/Microprismatic	Body	Extruded Aluminum	Dimmable	On request
Fixation material	Aluminum	Diffuser	PC Opal/Microprismatic	Trimless	N/A
Length	On request	UV Protection	Yes	Colour Temperature	2700K → 6000K
Width	81 mm			IP Rate	IP44
Height	30 mm				

Electrical Specifications		Performance		Remarks
Input Voltage	220–240V	Power	12W–45W/m	Customized length
Input Frequency	50–60 hz	Luminous Flux	1200 lm–4500 lm/m	Angular shapes
Dimmable	On request	Luminous flux tolerance	10%	RGB version
Output	24V	Colour Temperature	2700 K → 6000 K	
IP Rate	IP20-IP67	Colour Rendering Index	≥80	
Power Factor	–	LED Luminaire Efficacy	100 lm/W	
Power	–			

PLD 630

NUBA

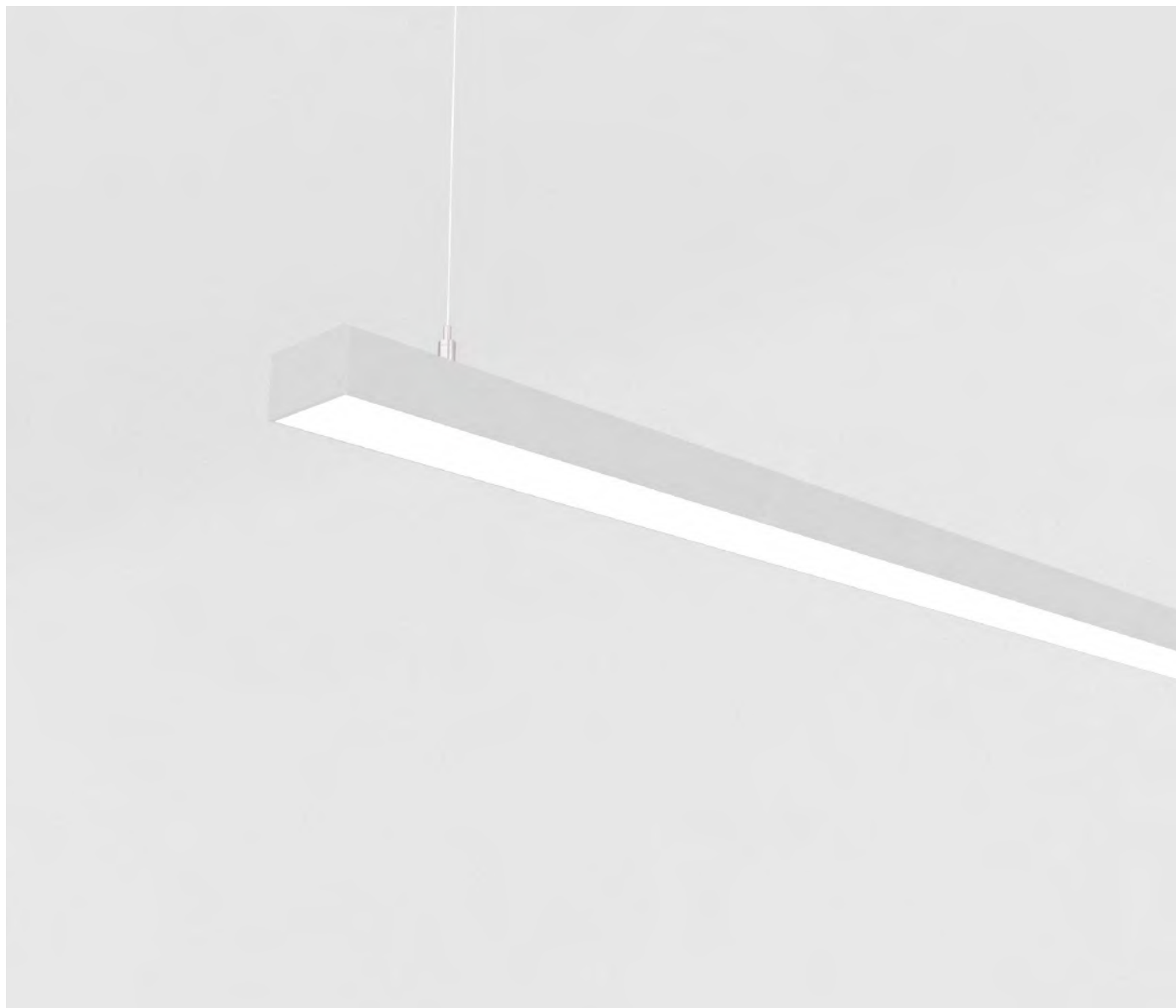
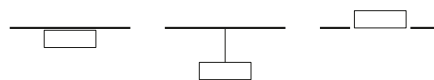

Product	
Code	PLD 630
Name	NUBA
Categories	PROFIL
Subcategory	Linear
	Decorative
Type	Pendant
	Ceiling lamp
	Trimless
Length	< 5 M
Finishing	RAL on request

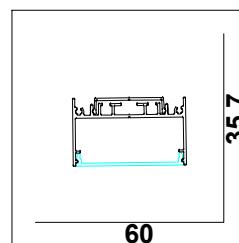

Product Specifications		General Information		Lamp Specifications	
Product Code	PLD 630	Suspension System	2 wire set	Lamp Type	LED
Body	Extruded Aluminum	Protection	IP40	LED Chip	Samsung
Number of light source	2	Installation	Indoor	Luminous Flux	110 lm/W
Light source color	2700 K -> 6000 K	Mounting	Surface mounted/ Pendant	Power	4 W-20 W/m
Cap-Base	22 cm	Trimless	On request	Colour Temperature	2700 K -> 6000 K
Light source replacable	Yes	Warranty Period	2 years	Length	2.5 cm -> 50 cm
Luminaire light beam	120°			Width	0.8 cm

PLD 630

NUBA

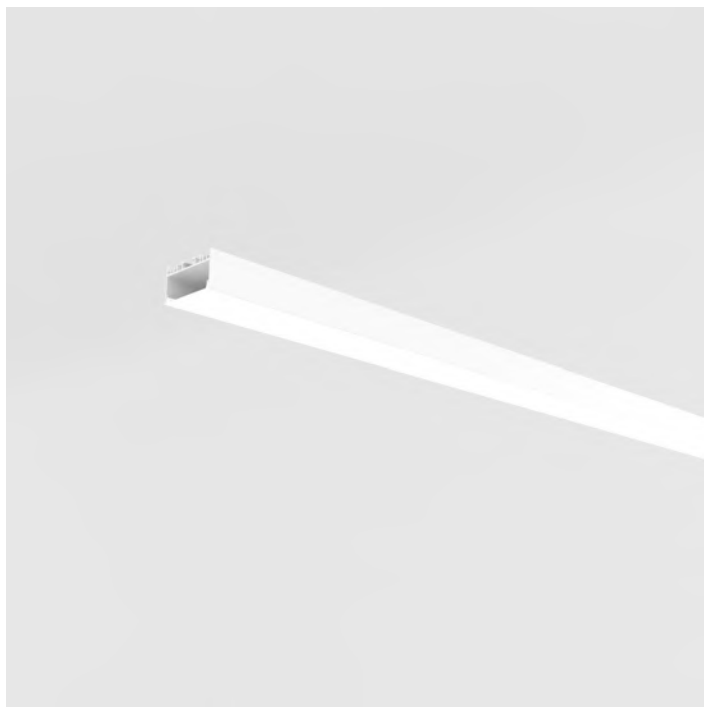
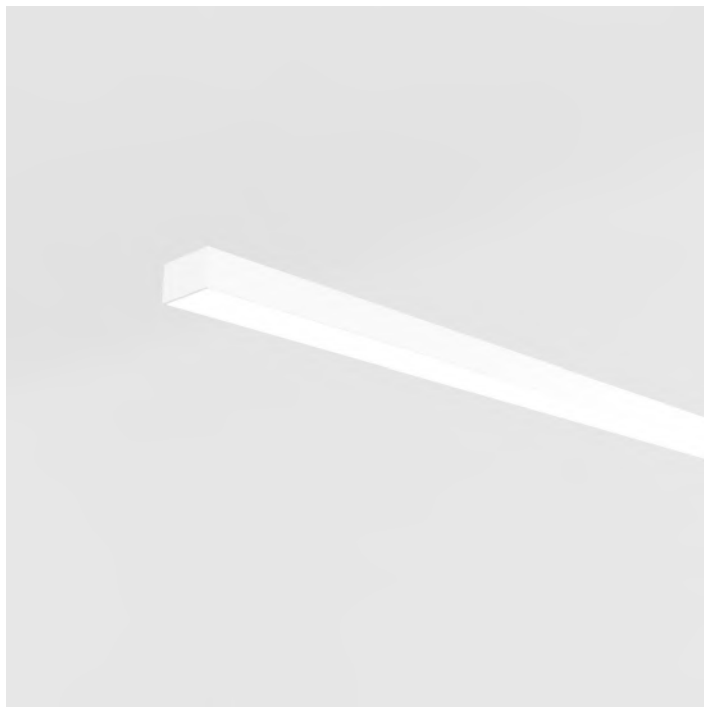
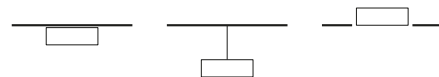

Physical Specifications		Physical Specifications		Options	
Structure	Extruded Aluminum	Finishing	Aluminum anodized/RAL	Length	On request
Reflector	N/A	Weight	-	Finish	RAL on request
Optical Cover	PC Opal/Microprismatic	Body	Extruded Aluminum	Dimmable	On request
Fixation material	Aluminum/Stainless Steel	Diffuser	PC Opal/Microprismatic	Trimless	On request
Length	On request	UV Protection	Yes	Colour Temperature	2700K -> 6000K
Width	60 mm			IP Rate	IP44
Height	35.7 mm				
Electrical Specifications		Performance		Remarks	
Input Voltage	220-240V	Power	8W-40W/m	Customized length	
Input Frequency	50-60 hz	Luminous Flux	800 lm-4000 lm/m	Angular shapes	
Dimmable	On request	Luminous flux tolerance	10%	RGB version	
Output	24V	Colour Temperature	2700 K -> 6000 K		
IP Rate	IP20-IP67	Colour Rendering Index	≥80		
Power Factor	-	LED Luminaire Efficacy	100 lm/W		
Power	-				

PLD 610

VENTY

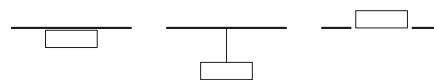

Product	
Code	PLD 610
Name	VENTY
Categories	PROFIL
Subcategory	Linear
	Decorative
Type	Pendant
	Ceiling lamp
	Trimless
Length	< 5 M
Finishing	RAL on request

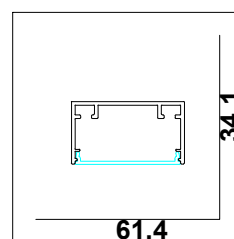

Product Specifications	General Information	Lamp Specifications			
Product Code	PLD 610	Suspension System	2 wire set	Lamp Type	LED
Body	Extruded Aluminum	Protection	IP40	LED Chip	Samsung
Number of light source	2	Installation	Indoor	Luminous Flux	110 lm/W
Light source color	2700 K → 6000 K	Mounting	Surface mounted/ Pendant	Power	4 W–20 W/m
Cap-Base	22 cm	Trimless	On request	Colour Temperature	2700 K → 6000 K
Light source replacable	Yes	Warranty Period	2 years	Length	2.5 cm → 50 cm
Luminaire light beam	120°			Width	0.8 cm

PLD 610

VENTY

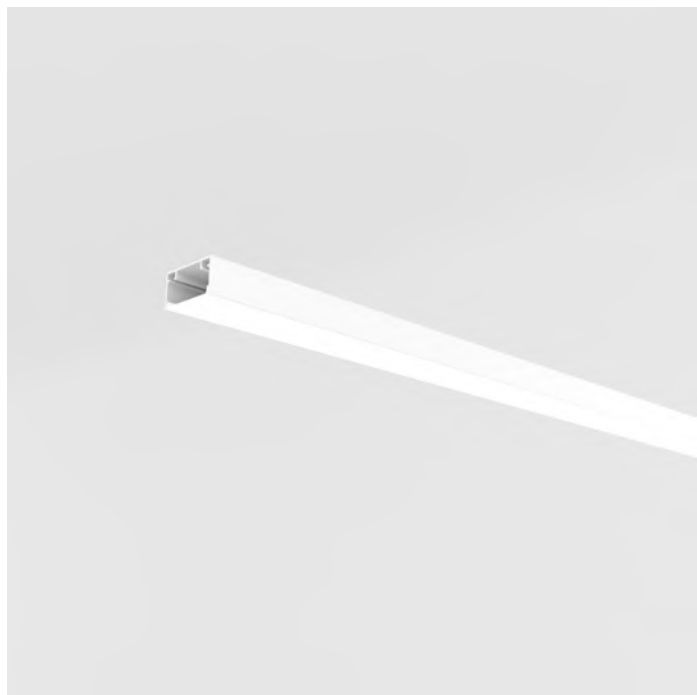
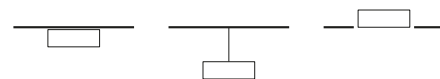

Physical Specifications		Physical Specifications		Options	
Structure	Extruded Aluminum	Finishing	Aluminum anodized/RAL	Length	On request
Reflector	N/A	Weight	-	Finish	RAL on request
Optical Cover	PC Opal/Microprismatic	Body	Extruded Aluminum	Dimmable	On request
Fixation material	Aluminum/Stainless Steel	Diffuser	PC Opal/Microprismatic	Trimless	On request
Length	On request	UV Protection	Yes	Colour Temperature	2700K → 6000K
Width	61.4 mm			IP Rate	IP44
Height	34.1 mm				

Electrical Specifications		Performance		Remarks	
Input Voltage	220–240V	Power	8W–40W/m	Customized length	
Input Frequency	50–60 Hz	Luminous Flux	800 lm–4000 lm/m	Angular shapes	
Dimmable	On request	Luminous flux tolerance	10%	RGB version	
Output	24V	Colour Temperature	2700 K → 6000 K		
IP Rate	IP20-IP67	Colour Rendering Index	≥80		
Power Factor	-	LED Luminaire Efficacy	100 lm/W		
Power	-				

PLD 600

POTT

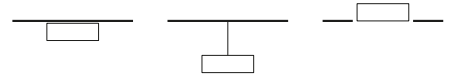

Product	
Code	PLD 600
Name	POTT
Categories	PROFIL
Subcategory	Linear
	Decorative
Type	Pendant
	Ceiling lamp
	Trimless
Length	< 5 M
Finishing	RAL on request

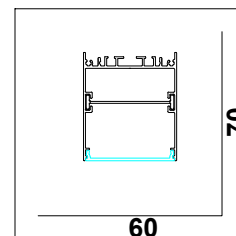

Product Specifications		General Information		Lamp Specifications	
Product Code	PLD 600	Suspension System	2 wire set	Lamp Type	LED
Body	Extruded Aluminum	Protection	IP40	LED Chip	Samsung
Number of light source	2	Installation	Indoor	Luminous Flux	110 lm/W
Light source color	2700 K -> 6000 K	Mounting	Surface mounted/ Pendant	Power	4 W-20 W/m
Cap-Base	6 cm	Trimless	On request	Colour Temperature	2700 K -> 6000 K
Light source replacable	Yes	Warranty Period	2 years	Length	2.5 cm -> 50 cm
Luminaire light beam	120°			Width	0.8 cm

PLD 600

POTT

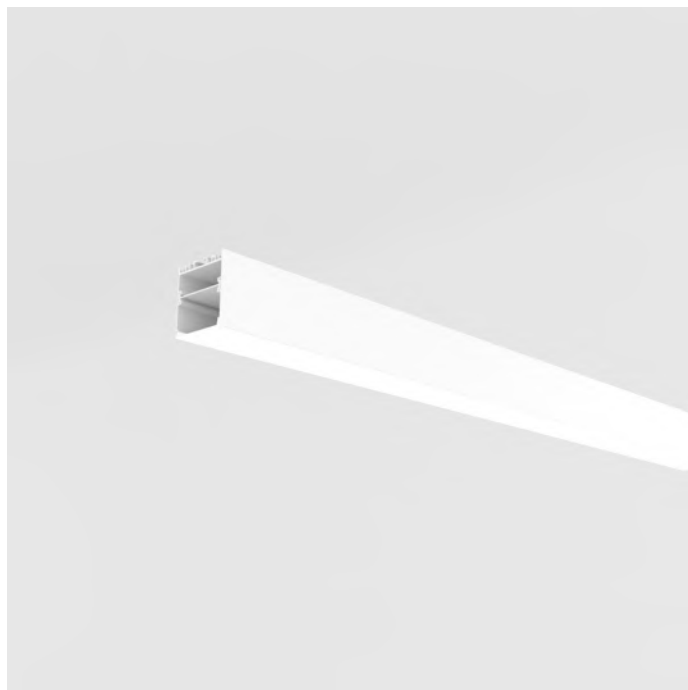
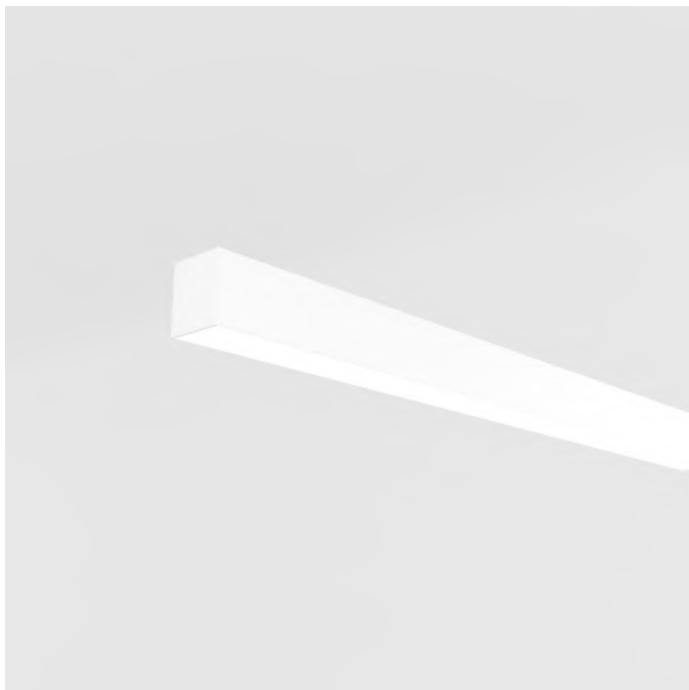
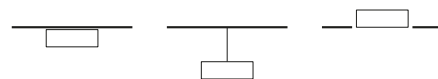

Physical Specifications		Physical Specifications		Options	
Structure	Extruded Aluminum	Finishing	Aluminum anodized/RAL	Length	On request
Reflector	N/A	Weight	-	Finish	RAL on request
Optical Cover	PC Opal/Microprismatic	Body	Extruded Aluminum	Dimmable	On request
Fixation material	Aluminum/Stainless Steel	Diffuser	PC Opal/Microprismatic	Trimless	On request
Length	On request	UV Protection	Yes	Colour Temperature	2700K → 6000K
Width	60 mm			IP Rate	IP44
Height	70 mm				

Electrical Specifications		Performance		Remarks	
Input Voltage	220-240V	Power	8W-40W/m	Customized length	
Input Frequency	50-60 Hz	Luminous Flux	800 lm-4000 lm/m	Angular shapes	
Dimmable	On request	Luminous flux tolerance	10%	RGB version	
Output	24V	Colour Temperature	2700 K → 6000 K		
IP Rate	IP20-IP67	Colour Rendering Index	≥80		
Power Factor	-	LED Luminaire Efficacy	100 lm/W		
Power	-				

PLD 550

FITT

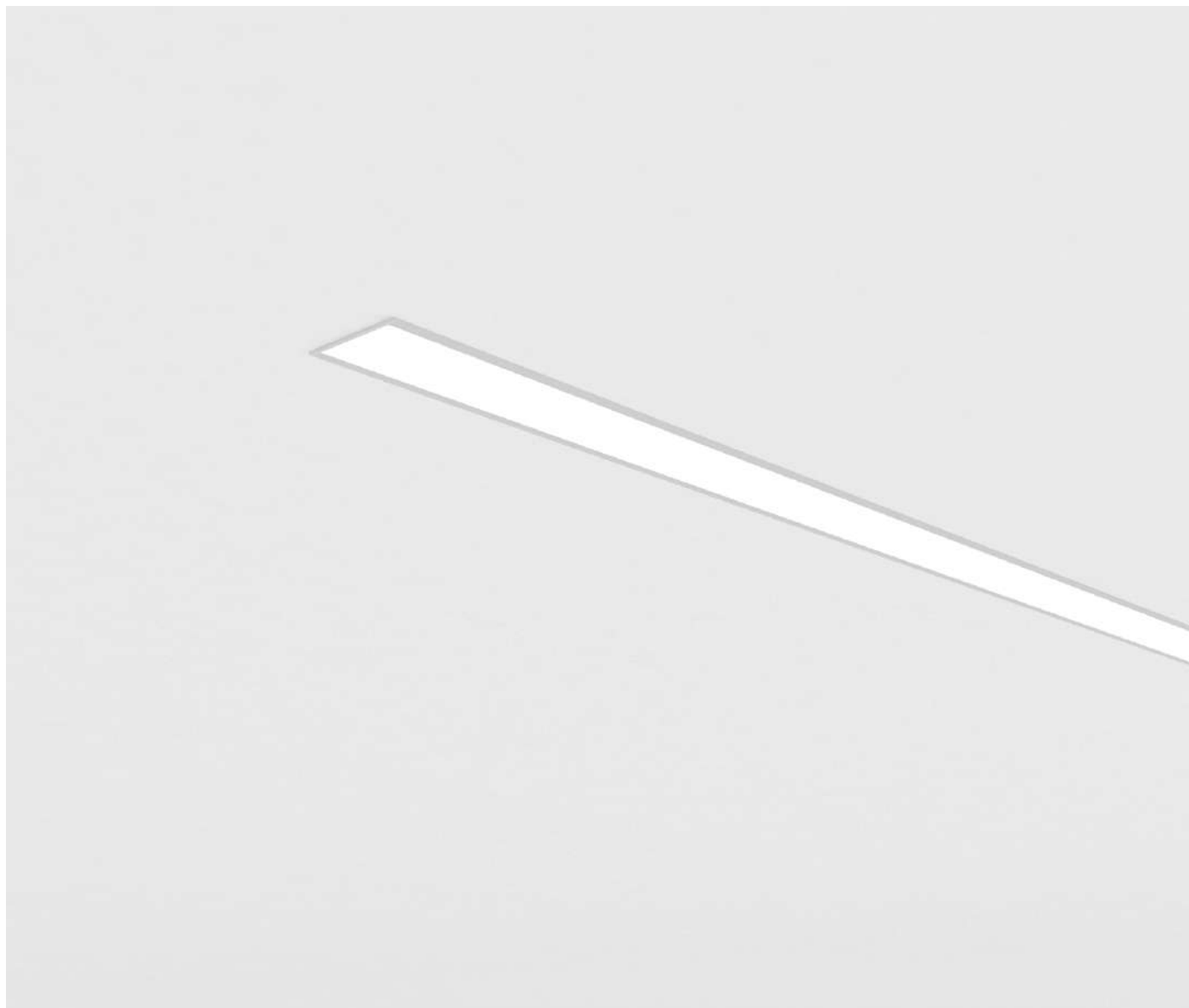

Product	
Code	PLD 550
Name	FITT
Categories	PROFIL
Subcategory	Linear
	Decorative
Type	Recessed
Length	< 5 M
Finishing	RAL on request

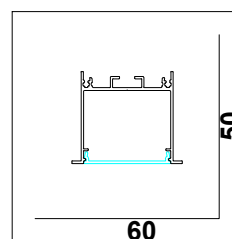

Product Specifications		General Information		Lamp Specifications	
Product Code	PLD 550	Installation	Ceiling Recessed	Lamp Type	LED
Body	Extruded Aluminum	Protection	IP40	LED Chip	Samsung
Number of light source	1	Installation	Indoor	Luminous Flux	110 lm/W
Light source color	2700 K → 6000 K	Mounting	Recessed with springs	Power	4 W–20 W/m
Cap-Base	N/A	Trimless	N/A	Colour Temperature	2700 K → 6000 K
Light source replacable	Yes	Warranty Period	2 years	Length	2.5 cm → 50 cm
Luminaire light beam	120°			Width	0.8 cm

PLD 550

FITT

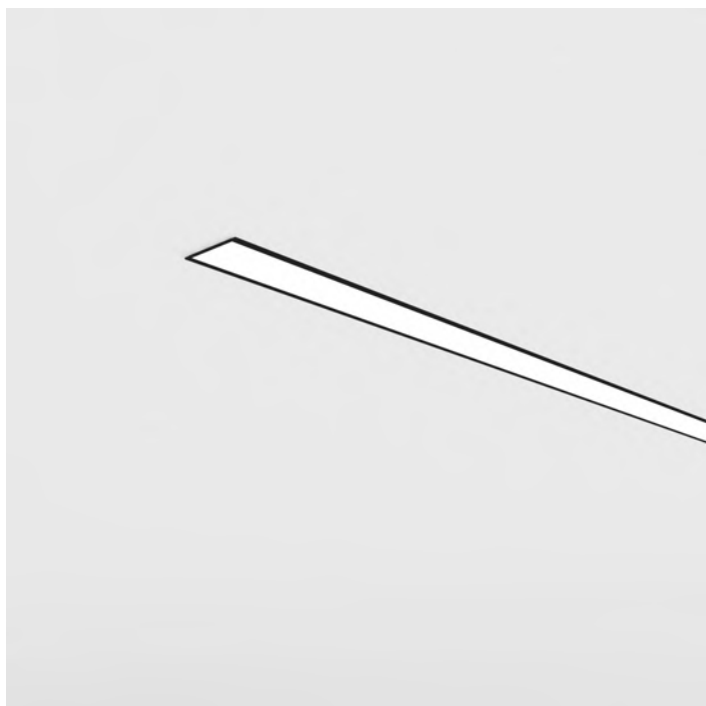

Physical Specifications		Physical Specifications		Options	
Structure	Extruded Aluminum	Finishing	Aluminum anodized/RAL	Length	On request
Reflector	N/A	Weight	-	Finish	RAL on request
Optical Cover	PC Opal/Microprismatic	Body	Extruded Aluminum	Dimmable	On request
Fixation material	Aluminum	Diffuser	PC Opal/Microprismatic	Trimless	N/A
Length	On request	UV Protection	Yes	Colour Temperature	2700K → 6000K
Width	60 mm			IP Rate	IP44
Height	50mm				

Electrical Specifications		Performance		Remarks	
Input Voltage	220-240V	Power	4W-20W/m	Customized length	
Input Frequency	50-60 hz	Luminous Flux	400 lm-2000 lm/m	Angular shapes	
Dimmable	On request	Luminous flux tolerance	10%	RGB version	
Output	24V	Colour Temperature	2700 K → 6000 K		
IP Rate	IP20-IP67	Colour Rendering Index	≥80		
Power Factor	-	LED Luminaire Efficacy	100 lm/W		
Power	-				

PLD 500

CALA

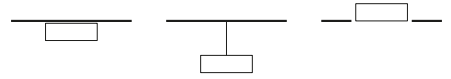

Product	
Code	PLD 500
Name	CALA
Categoriees	PROFIL
Subcategory	Linear
Type of Mounted	Decorative Pendant Ceiling lamp Trimless
Customized Lenght	< 5 M
Custom Finish	RAL on request

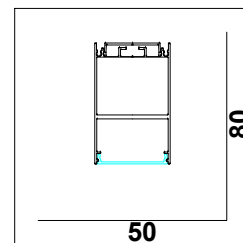

Product Specifications	General Information	Lamp Specifications
Product Code	PLD.500	Suspension System
Body	Extruded Aluminum	Protection
Number of light source	2	Installation
Light source color	2700 K → 6000 K	Mounting
Cap-Base	6 cm	Trimless
Light source replacable	Yes	Warranty Period
Luminaire light beam	120°	
		Lamp Type
		LED Chip
		Luminous Flux
		Power
		Colour Temperature
		Length
		Width

PLD 500

CALA

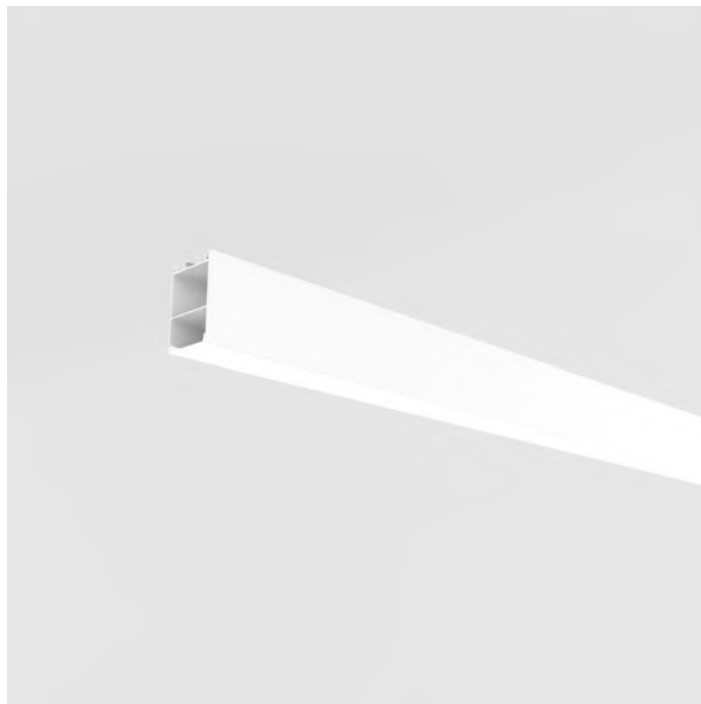
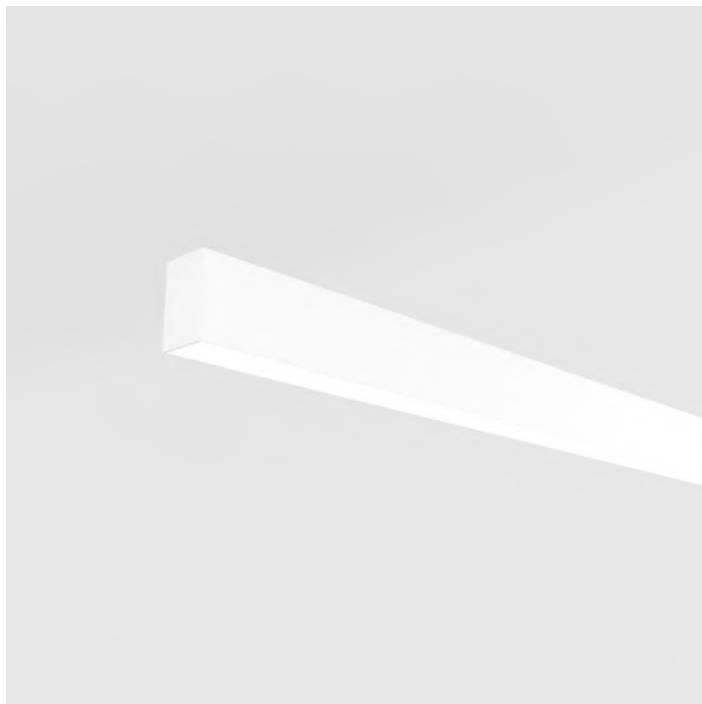
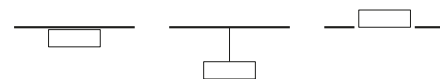

Physical Specifications		Physical Specifications		Options	
Structure	Extruded Aluminum	Finishing	Aluminum anodized/RAL	Length	On request
Reflector	N/A	Weight	–	Finish	RAL on request
Optical Cover	PC Opal/Microprismatic	Body	Extruded Aluminum	Dimmable	On request
Fixation material	Aluminium/Stainless Steel	Diffuser	PC Opal/Microprismatic	Trimless	On request
Length	On request	UV Protection	–	Colour Temperature	2700K → 6000K
Width	50 mm			IP Rate	IP44
Height	80 mm				

Electrical Specifications		Performance		Remarks	
Input Voltage	220–240V	Power	8 W–40 W/m	Customized length	
Input Frequency	50–60 Hz	Luminous Flux	800 lm–4000 lm/m	Angular shapes	
Dimmable	On request	Luminous flux tolerance	10%	RGB version	
Output	24V	Colour Temperature	2700 K → 6000 K		
IP Rate	IP20-IP67	Colour Rendering Index	≥80		
Power Factor	–	LED Luminaire Efficacy	110 lm/W		
Power	–				

PLD 460

CARE

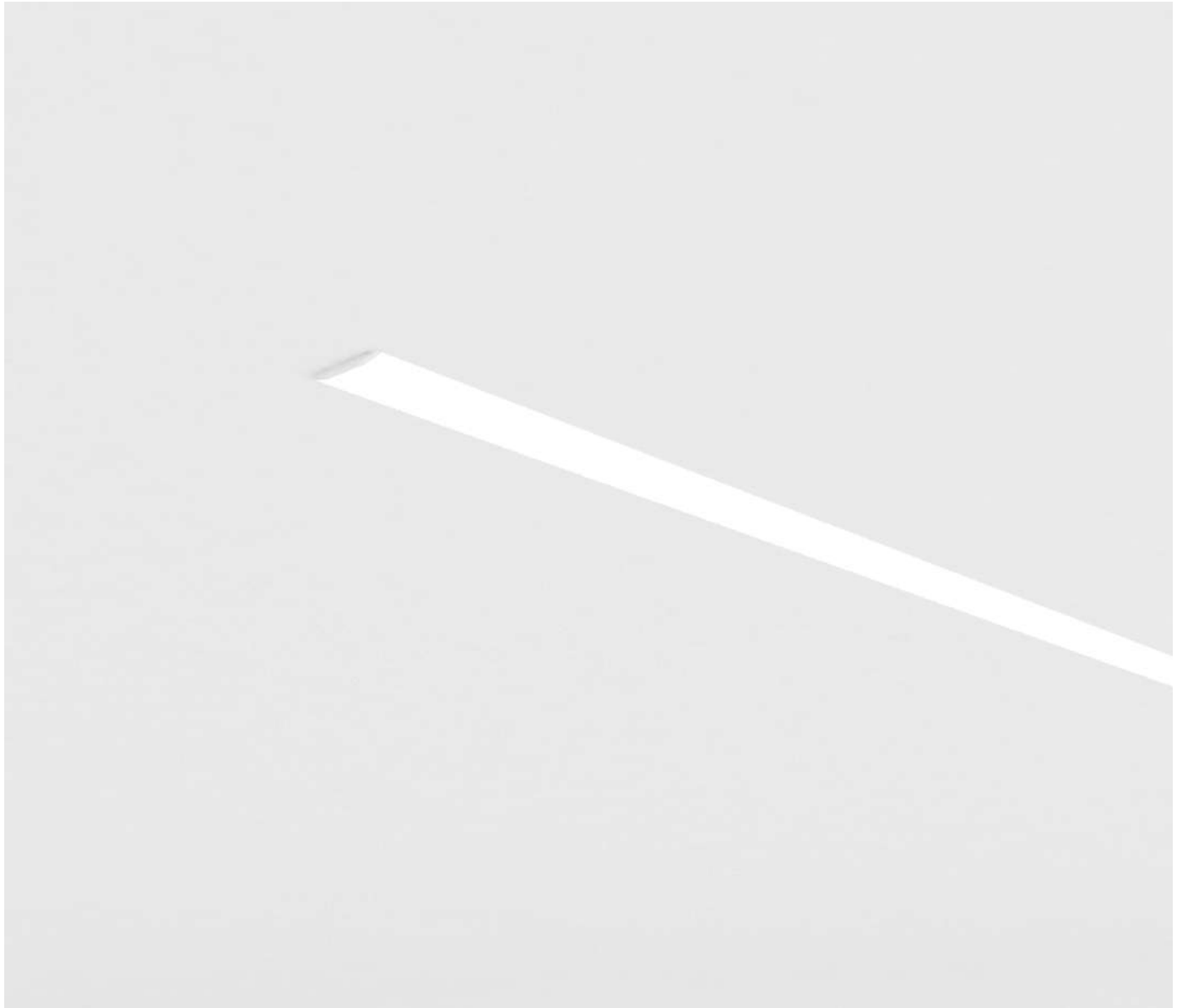

Product	
Code	PLD 460
Name	CARE
Categories	PROFIL
Subcategory	Linear
	Decorative
Type	Recessed
Length	< 5 M
Finishing	RAL on request

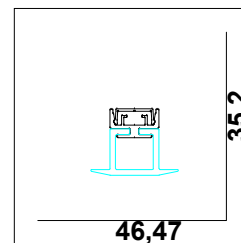

Product Specifications		General Information		Lamp Specifications	
Product Code	PLD 460	Installation	Ceiling Recessed	Lamp Type	LED
Body	Extruded Aluminum	Protection	IP40	LED Chip	Samsung
Number of light source	2	Installation	Indoor	Luminous Flux	110 lm/W
Light source color	2700 K → 6000 K	Mounting	Recessed with springs	Power	4 W–20 W/m
Cap-Base	N/A	Trimless	N/A	Colour Temperature	2700 K → 6000 K
Light source replacable	Yes	Warranty Period	2 years	Length	2.5 cm → 50 cm
Luminaire light beam	120°			Width	0.8 cm

PLD 460

CARE

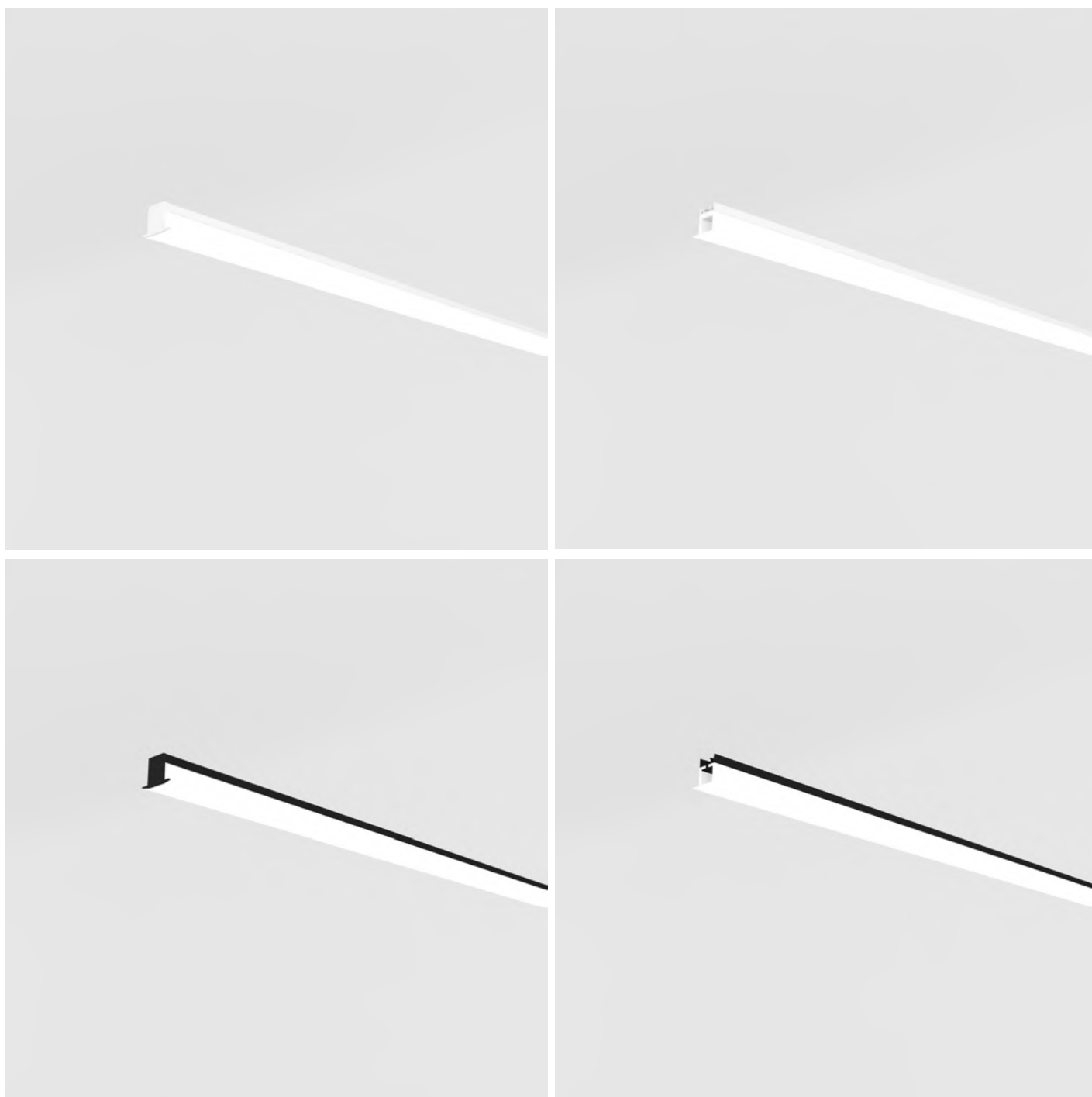

Physical Specifications		Physical Specifications		Options	
Structure	Extruded Aluminum	Finishing	Aluminum anodized/RAL	Length	On request
Reflector	N/A	Weight	-	Finish	RAL on request
Optical Cover	Acrylic	Body	Extruded Aluminum	Dimmable	On request
Fixation material	Aluminum	Diffuser	Acrylic	Trimless	N/A
Length	On request	UV Protection	Yes	Colour Temperature	2700K → 6000K
Width	46.47 mm			IP Rate	IP44
Height	35.2 mm				

Electrical Specifications		Performance		Remarks	
Input Voltage	220-240V	Power	8W-30W/m	Customized length	
Input Frequency	50-60 hz	Luminous Flux	800 lm-3000 lm/m	Angular shapes	
Dimmable	On request	Luminous flux tolerance	10%	RGB version	
Output	24V	Colour Temperature	2700 K → 6000 K		
IP Rate	IP20-IP67	Colour Rendering Index	≥80		
Power Factor	-	LED Luminaire Efficacy	100 lm/W		
Power	-				

PLD 440

MIRA

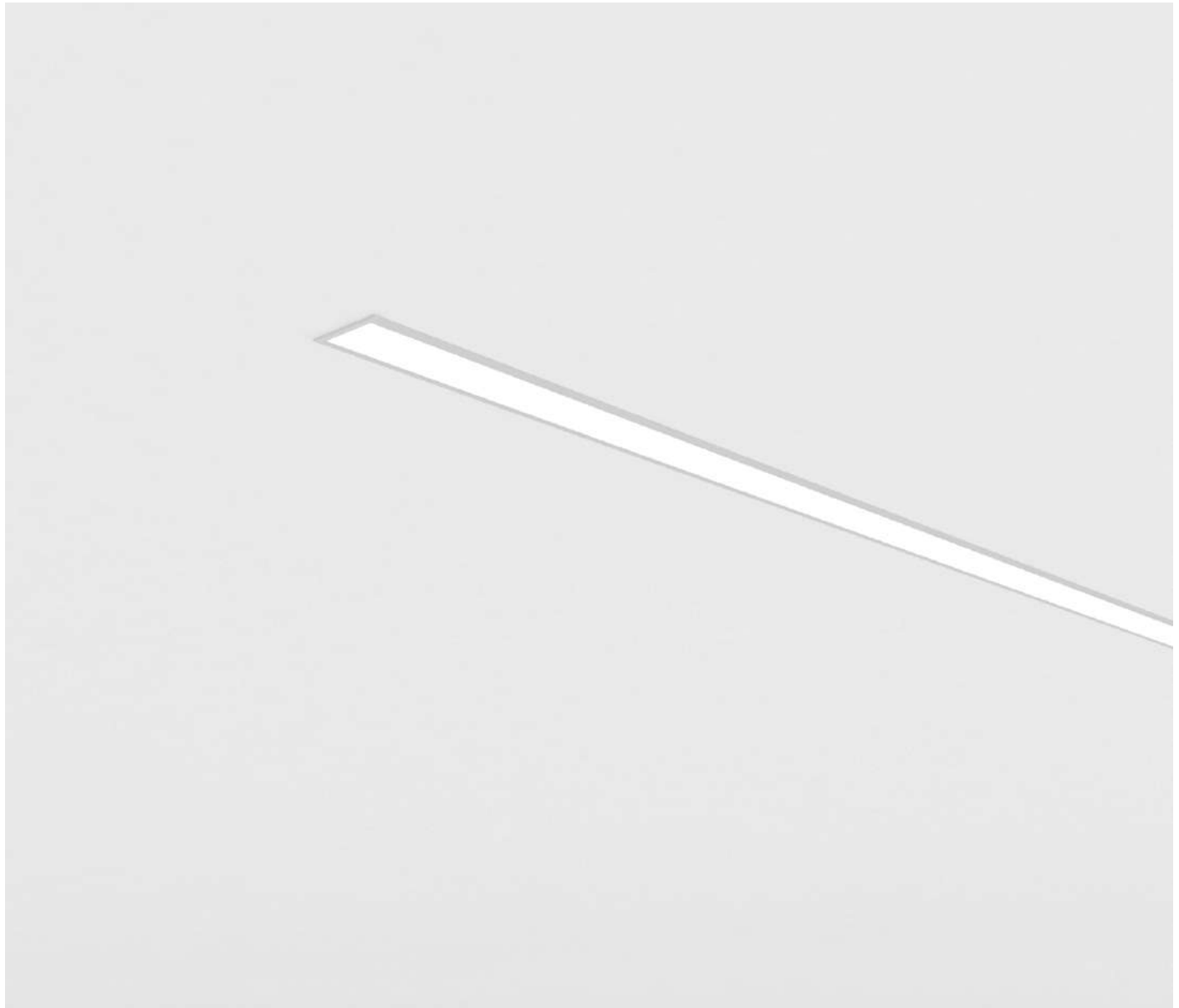

Product	
Code	PLD 440
Name	MIRA
Categories	PROFIL
Subcategory	Linear
Type	Decorative
	Recessed
Length	< 5 M
Finishing	RAL on request

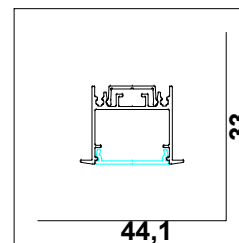

Product Specifications		General Information		Lamp Specifications	
Product Code	PLD 440	Installation	Ceiling Recessed	Lamp Type	LED
Body	Extruded Aluminum	Protection	IP40	LED Chip	Samsung
Number of light source	1	Installation	Indoor	Luminous Flux	110 lm/W
Light source color	2700 K -> 6000 K	Mounting	Recessed with springs	Power	4 W-20 W/m
Cap-Base	N/A	Trimless	N/A	Colour Temperature	2700 K -> 6000 K
Light source replacable	Yes	Warranty Period	2 years	Length	2.5 cm -> 50 cm
Luminaire light beam	120°			Width	0.8 cm

PLD 440

MIRA

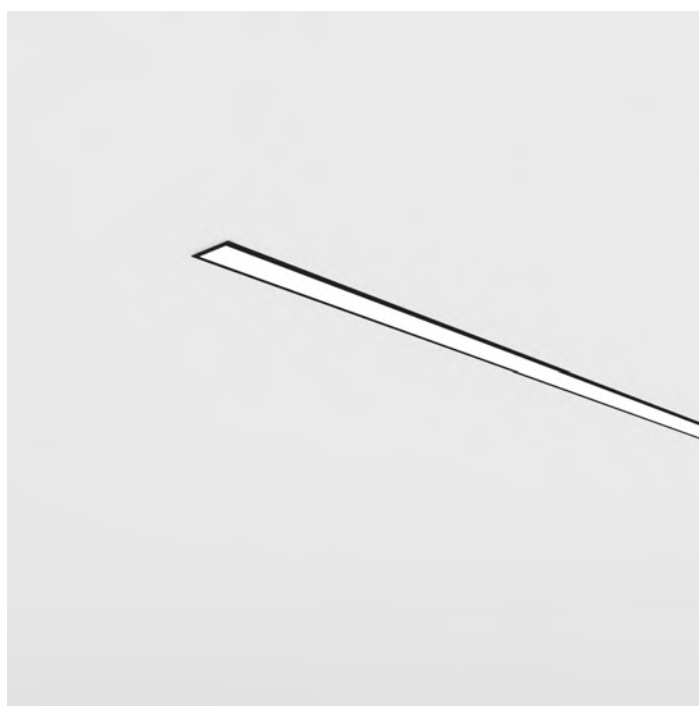

Physical Specifications		Physical Specifications		Options	
Structure	Extruded Aluminum	Finishing	Aluminum anodized/RAL	Length	On request
Reflector	N/A	Weight	–	Finish	RAL on request
Optical Cover	PC Opal/Microprismatic	Body	Extruded Aluminum	Dimmable	On request
Fixation material	Aluminum	Diffuser	PC Opal/Microprismatic	Trimless	N/A
Length	On request	UV Protection	Yes	Colour Temperature	2700K → 6000K
Width	44.1 mm			IP Rate	IP44
Height	33 mm				

Electrical Specifications		Performance		Remarks	
Input Voltage	220–240V	Power	4W–20W/m	Customized length	
Input Frequency	50–60 Hz	Luminous Flux	400 lm–2000 lm/m	Angular shapes	
Dimmable	On request	Luminous flux tolerance	10%	RGB version	
Output	24V	Colour Temperature	2700 K → 6000 K		
IP Rate	IP20-IP67	Colour Rendering Index	≥80		
Power Factor	–	LED Luminaire Efficacy	100 lm/W		
Power	–				

PLD 420

GOA

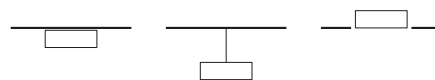

Product	
Code	PLD 420
Name	GOA
Categories	PROFIL
Subcategory	Linear
	Decorative
Type	Pendant
	Ceiling lamp
	Trimless
Lenght	< 5 M
Finishing	RAL on request

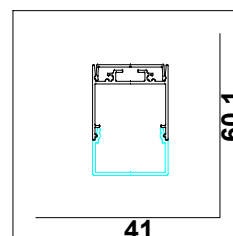

Product Specifications		General Information		Lamp Specifications	
Product Code	PLD 420	Suspension System	2 wire set	Lamp Type	LED
Body	Extruded Aluminum	Protection	IP40	LED Chip	Samsung
Number of light source	2	Installation	Indoor	Luminous Flux	110 lm/W
Light source color	2700 K -> 6000 K	Mounting	Surface mounted/ Pendant	Power	4 W-20 W/m
Cap-Base	22 cm	Trimless	On request	Colour Temperature	2700 K -> 6000 K
Light source replacable	Yes	Warranty Period	2 years	Length	2.5 cm -> 50 cm
Luminaire light beam	120°			Width	0.8 cm

PLD 420

GOA

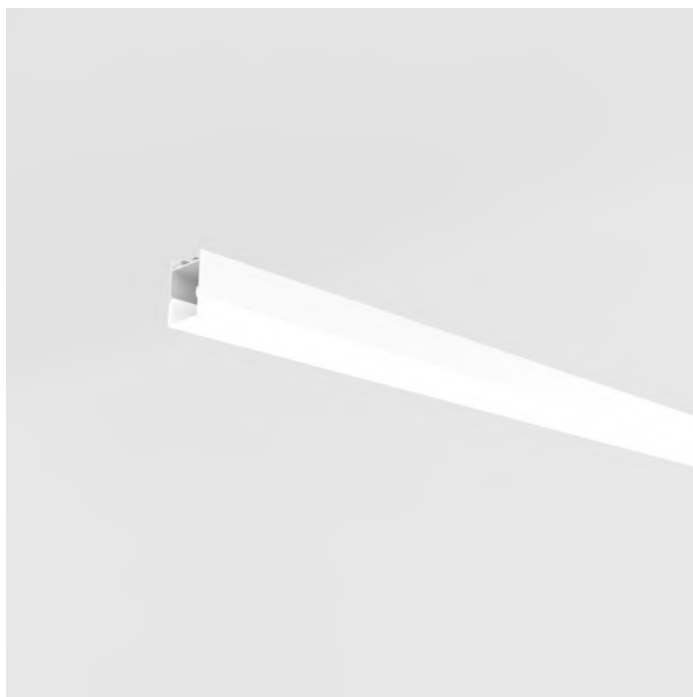
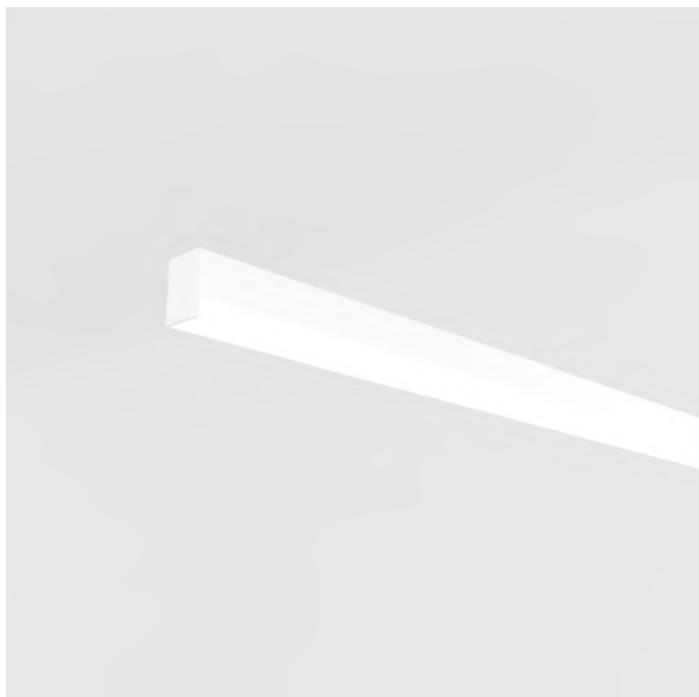
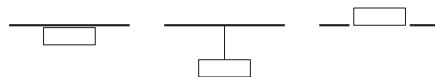

Physical Specifications		Physical Specifications		Options	
Structure	Extruded Aluminum	Finishing	Aluminum anodized/RAL	Length	On request
Reflector	N/A	Weight	-	Finish	RAL on request
Optical Cover	PC Opal	Body	Extruded Aluminum	Dimmable	On request
Fixation material	Aluminum/Stainless Steel	Diffuser	PC Opal	Trimless	On request
Length	On request	UV Protection	Yes	Colour Temperature	2700K -> 6000K
Width	41 mm			IP Rate	IP44
Height	60.1 mm				
Electrical Specifications		Performance		Remarks	
Input Voltage	220-240V	Power	8W-40W/m	Customized length	
Input Frequency	50-60 hz	Luminous Flux	800 lm-4000 lm/m	Angular shapes	
Dimmable	On request	Luminous flux tolerance	10%	RGB version	
Output	24V	Colour Temperature	2700 K -> 6000 K		
IP Rate	IP20-IP67	Colour Rendering Index	≥80		
Power Factor	-	LED Luminaire Efficacy	100 lm/W		
Power	-				

PLD 410

SEM

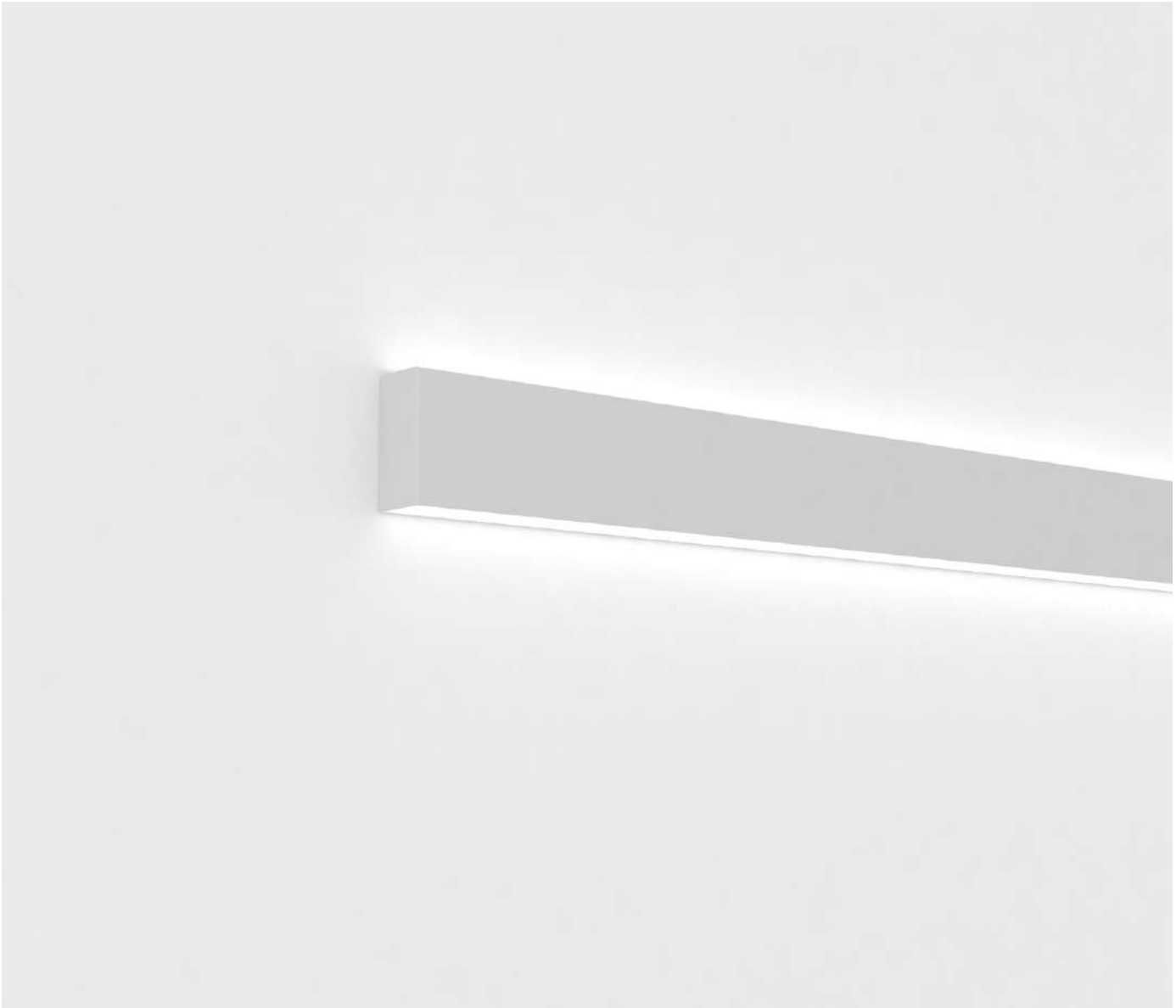
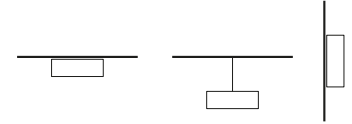

Product	
Code	PLD 410
Name	SEM
Categories	PROFIL
Subcategory	Linear
	Decorative
Type	Pendant
	Wall lamp
	Ceiling lamp
Length	< 5 M
Finishing	RAL on request

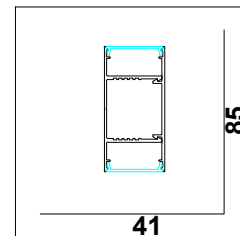

Product Specifications		General Information		Lamp Specifications	
Product Code	PLD 410	Suspension System	2 wire set	Lamp Type	LED
Body	Extruded Aluminum	Protection	IP40	LED Chip	Samsung
Number of light source	2	Installation	Indoor	Luminous Flux	110 lm/W
Light source color	2700 K -> 6000 K	Mounting	Surface & wall mounted/ Pendant	Power	4 W-20 W/m
Cap-Base	N/A	Trimless	N/A	Colour Temperature	2700 K -> 6000 K
Light source replacable	Yes	Warranty Period	2 years	Length	2.5 cm -> 50 cm
Luminaire light beam	120°			Width	0.8 cm

PLD 410

SEM

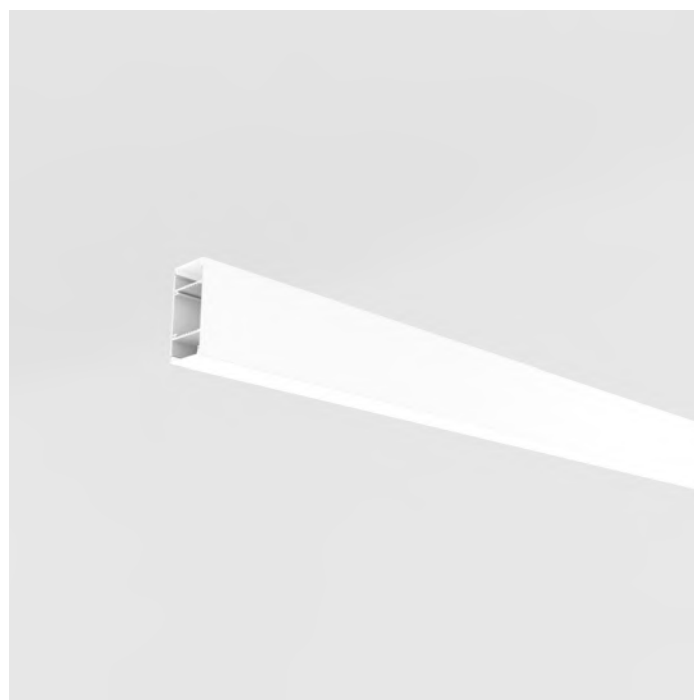
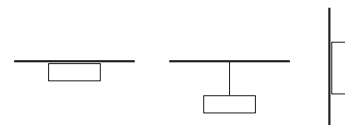

Physical Specifications		Physical Specifications		Options	
Structure	Extruded Aluminum	Finishing	Aluminum anodized/RAL	Length	On request
Reflector	N/A	Weight	-	Finish	RAL on request
Optical Cover	PC Opal/Microprismatic	Body	Extruded Aluminum	Dimmable	On request
Fixation material	Aluminum/Stainless Steel	Diffuser	PC Opal/Microprismatic	Trimless	N/A
Length	On request	UV Protection	Yes	Colour Temperature	2700K → 6000K
Width	41 mm			IP Rate	IP44
Height	85 mm				

Electrical Specifications		Performance		Remarks	
Input Voltage	220-240V	Power	8W-40W/m	Customized length	
Input Frequency	50-60 hz	Luminous Flux	800 lm-4000 lm/m	Angular shapes	
Dimmable	On request	Luminous flux tolerance	10%	RGB version	
Output	24V	Colour Temperature	2700 K → 6000 K		
IP Rate	IP20-IP67	Colour Rendering Index	≥80		
Power Factor	-	LED Luminaire Efficacy	100 lm/W		
Power	-				

PLD 400

RE-RE

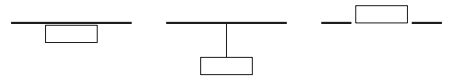

Product	
Code	PLD 400
Name	RE-RE
Categories	PROFIL
Subcategory	Linear
	Decorative
Type	Pendant
	Ceiling lamp
	Trimless
Length	< 5 M
Finishing	RAL on request

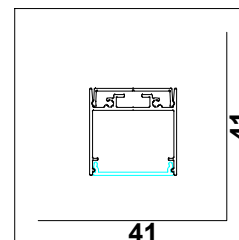

Product Specifications		General Information		Lamp Specifications	
Product Code	PLD 400	Suspension System	2 wire set	Lamp Type	LED
Body	Extruded Aluminum	Protection	IP40	LED Chip	Samsung
Number of light source	1	Installation	Indoor	Luminous Flux	110 lm/W
Light source color	2700 K → 6000 K	Mounting	Surface mounted/ Pendant	Power	4 W-20 W/m
Cap-Base	22 cm	Trimless	On request	Colour Temperature	2700 K → 6000 K
Light source replacable	Yes	Warranty Period	2 years	Length	2.5 cm → 50 cm
Luminaire light beam	120°			Width	0.8 cm

PLD 400

RE-RE

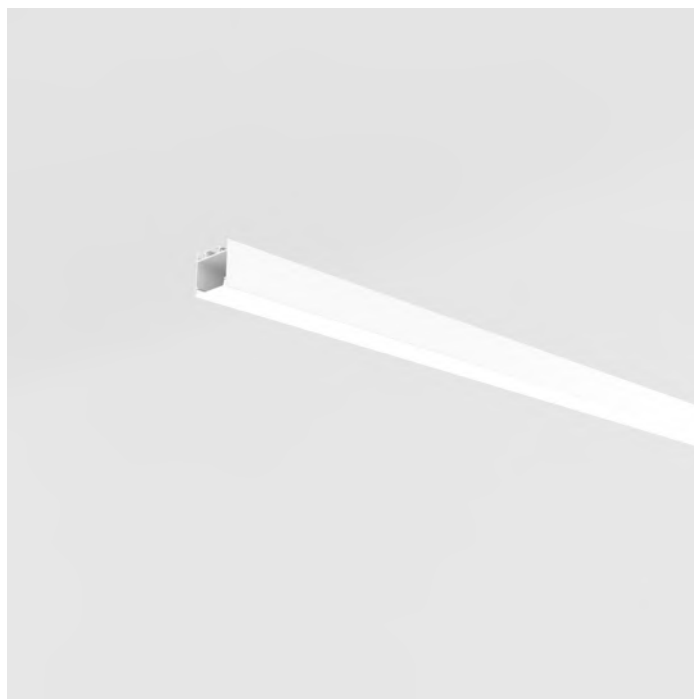
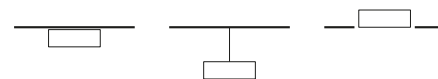

Physical Specifications		Physical Specifications		Options	
Structure	Extruded Aluminum	Finishing	Aluminum anodized/RAL	Length	On request
Reflector	N/A	Weight	-	Finish	RAL on request
Optical Cover	PC Opal/Microprismatic	Body	Extruded Aluminum	Dimmable	On request
Fixation material	Aluminum/Stainless Steel	Diffuser	PC Opal/Microprismatic	Trimless	On request
Length	On request	UV Protection	Yes	Colour Temperature	2700K -> 6000K
Width	41 mm			IP Rate	IP44
Height	41 mm				

Electrical Specifications		Performance		Remarks	
Input Voltage	220-240V	Power	4W-20W/m	Customized length	
Input Frequency	50-60 hz	Luminous Flux	400 lm-2000 lm/m	Angular shapes	
Dimmable	On request	Luminous flux tolerance	10%	RGB version	
Output	24V	Colour Temperature	2700 K -> 6000 K		
IP Rate	IP20-IP67	Colour Rendering Index	≥80		
Power Factor	-	LED Luminaire Efficacy	100 lm/W		
Power	-				

PLD 360

EQUILIBRO

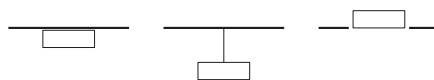

Product	
Code	PLD 360
Name	EQUILIBRO
Categories	PROFIL
Subcategory	Linear
	Decorative
Type	Pendant
	Ceiling lamp
	Trimless
Length	< 5 M
Finishing	RAL on request

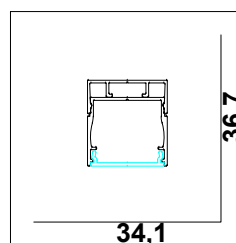

Product Specifications		General Information		Lamp Specifications	
Product Code	PLD 360	Suspension System	2 wire set	Lamp Type	LED
Body	Extruded Aluminum	Protection	IP40	LED Chip	Samsung
Number of light source	1	Installation	Indoor	Luminous Flux	110 lm/W
Light source color	2700 K → 6000 K	Mounting	Surface mounted/ Pendant	Power	4 W–20 W/m
Cap-Base	22 cm	Trimless	On request	Colour Temperature	2700 K → 6000 K
Light source replacable	Yes	Warranty Period	2 years	Length	2.5 cm → 50 cm
Luminaire light beam	120°			Width	0.8 cm

PLD 360

EQUILIBRO

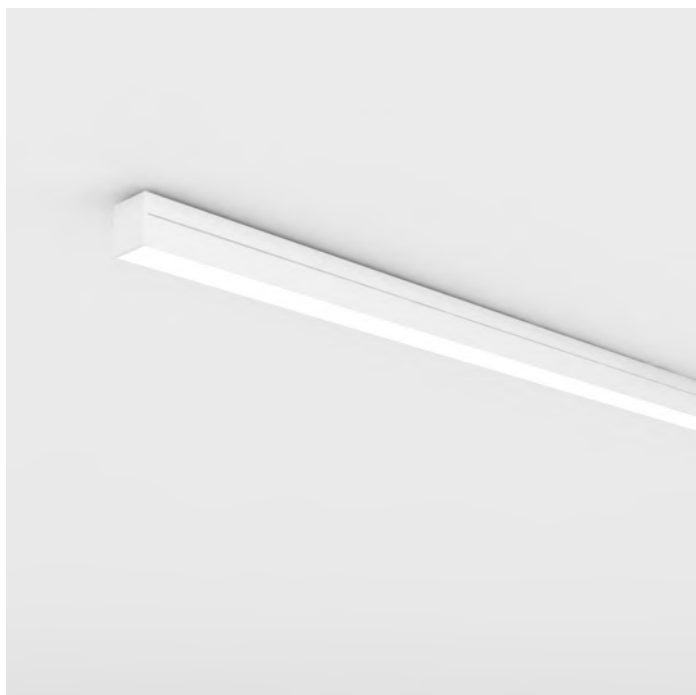
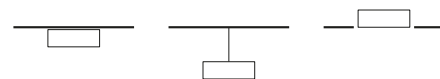

Physical Specifications		Physical Specifications		Options	
Structure	Extruded Aluminum	Finishing	Aluminum anodized/RAL	Length	On request
Reflector	N/A	Weight	-	Finish	RAL on request
Optical Cover	PC Opal/Microprismatic	Body	Extruded Aluminum	Dimmable	On request
Fixation material	Aluminum/Stainless Steel	Diffuser	PC Opal/Microprismatic	Trimless	On request
Length	On request	UV Protection	Yes	Colour Temperature	2700K → 6000K
Width	34.1 mm			IP Rate	IP44
Height	36.7 mm				

Electrical Specifications		Performance		Remarks	
Input Voltage	220-240V	Power	4W-20W/m	Customized length	
Input Frequency	50-60 hz	Luminous Flux	400 lm-2000 lm/m	Angular shapes	
Dimmable	On request	Luminous flux tolerance	10%	RGB version	
Output	24V	Colour Temperature	2700 K → 6000 K		
IP Rate	IP20-IP67	Colour Rendering Index	≥80		
Power Factor	-	LED Luminaire Efficacy	100 lm/W		
Power	-				

PLD 350

ARA

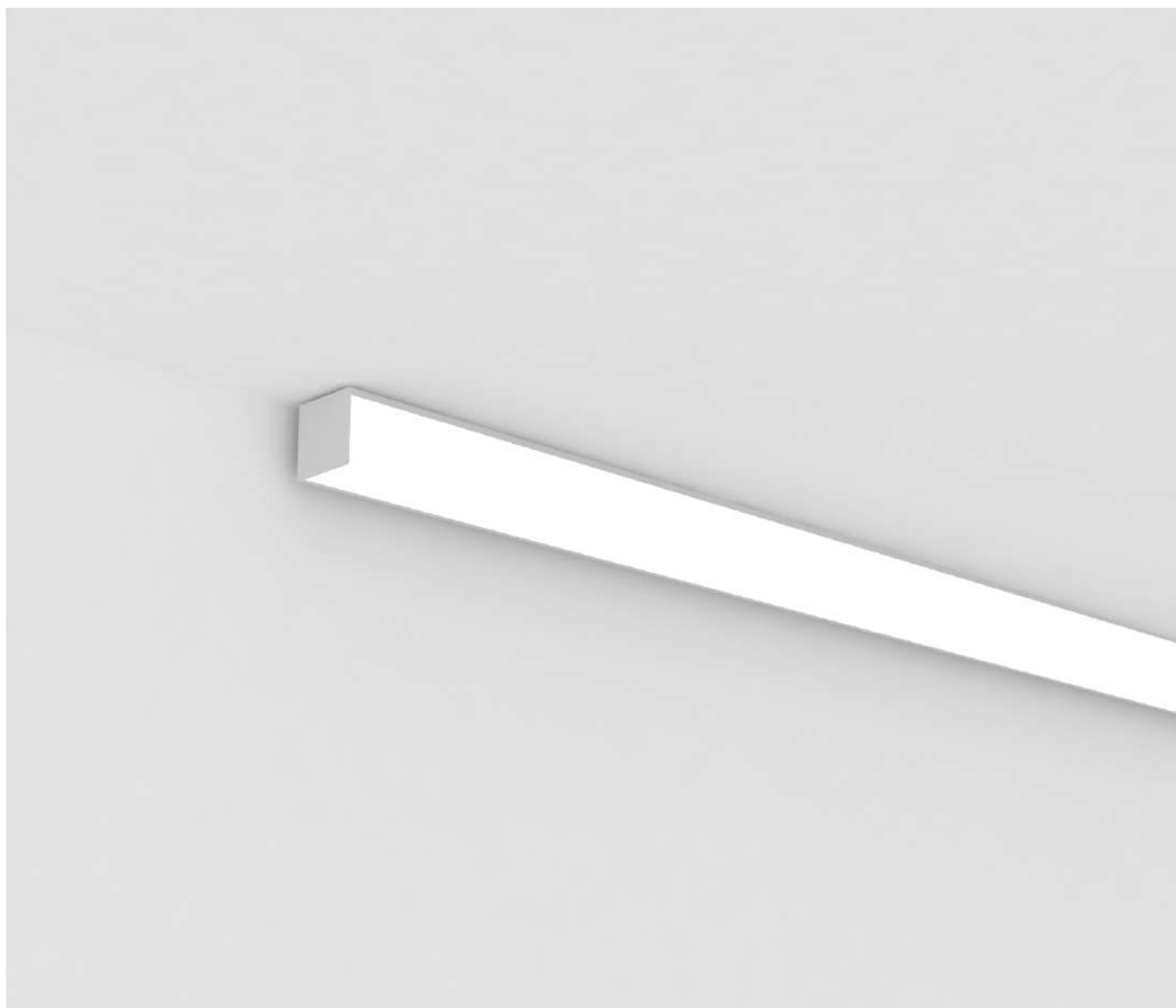
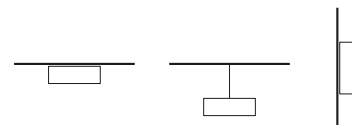

Product	
Code	PLD 350
Name	ARA
Categories	PROFIL
Subcategory	Linear
	Decorative
Type	Pendant
	Ceiling lamp
	Wall lamp
Length	< 5 M
Finishing	RAL on request

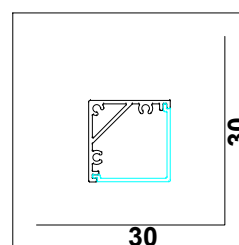

Product Specifications	General Information	Lamp Specifications			
Product Code	PLD 350	Suspension System	2 wire set	Lamp Type	LED
Body	Extruded Aluminum	Protection	IP40	LED Chip	Samsung
Number of light source	1	Installation	Indoor	Luminous Flux	110 lm/W
Light source color	2700 K → 6000 K	Mounting	Surface & wall mounted/ Pendant	Power	4 W-20 W/m
Cap-Base	22 cm	Trimless	N/A	Colour Temperature	2700 K → 6000 K
Light source replacable	Yes	Warranty Period	2 years	Length	2.5 cm → 50 cm
Luminaire light beam	120°			Width	0.8 cm

PLD 350

ARA

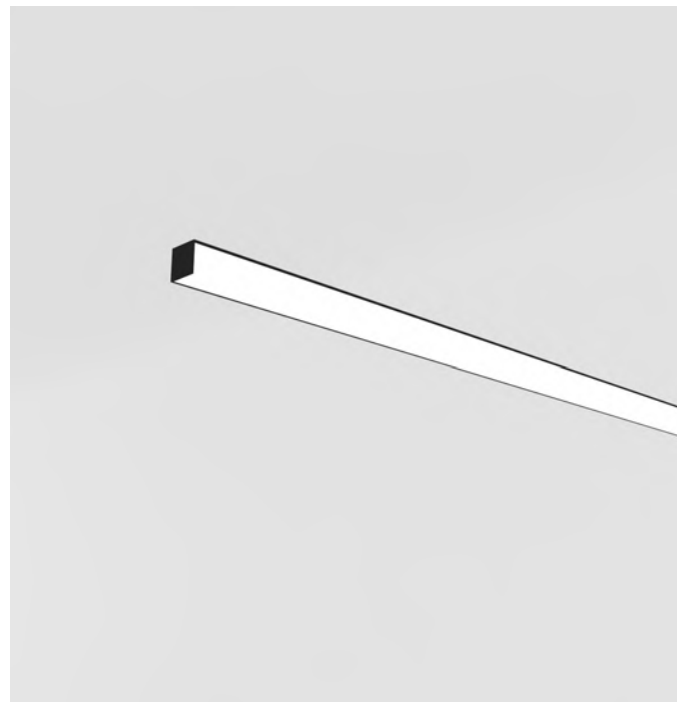
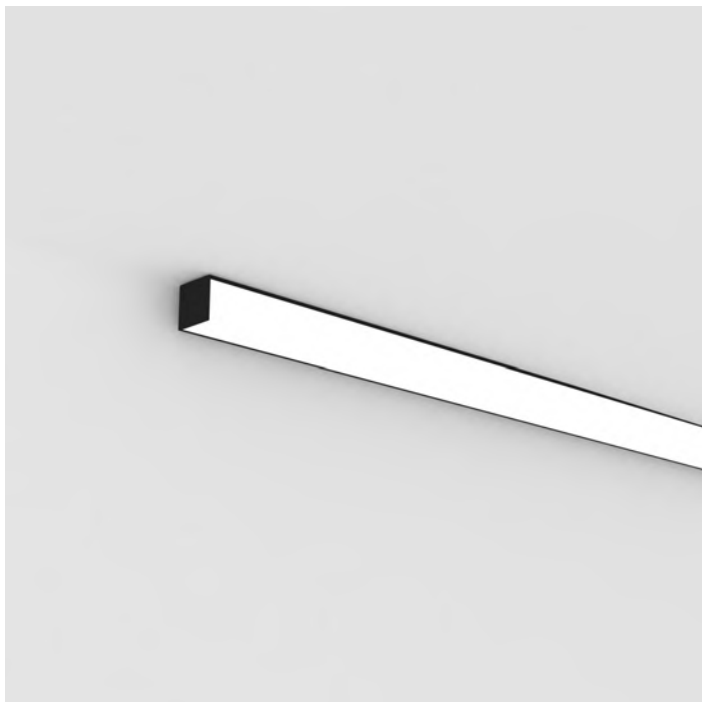
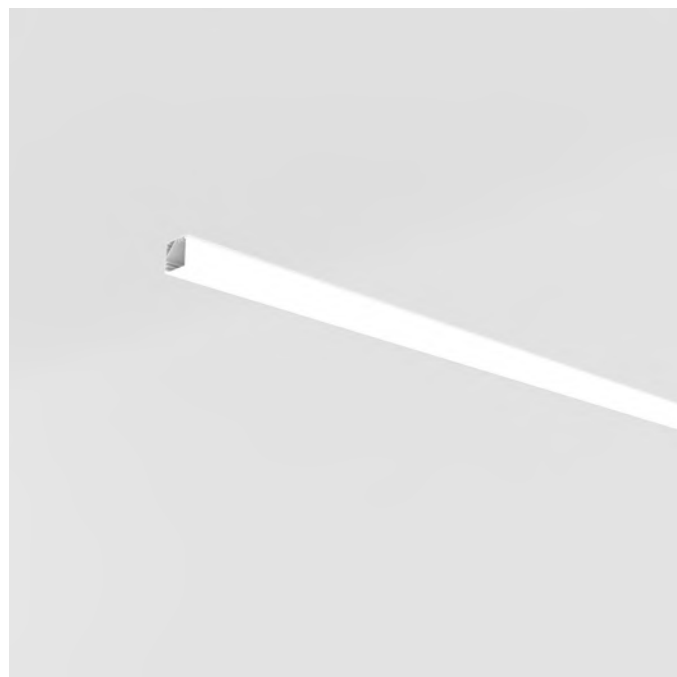
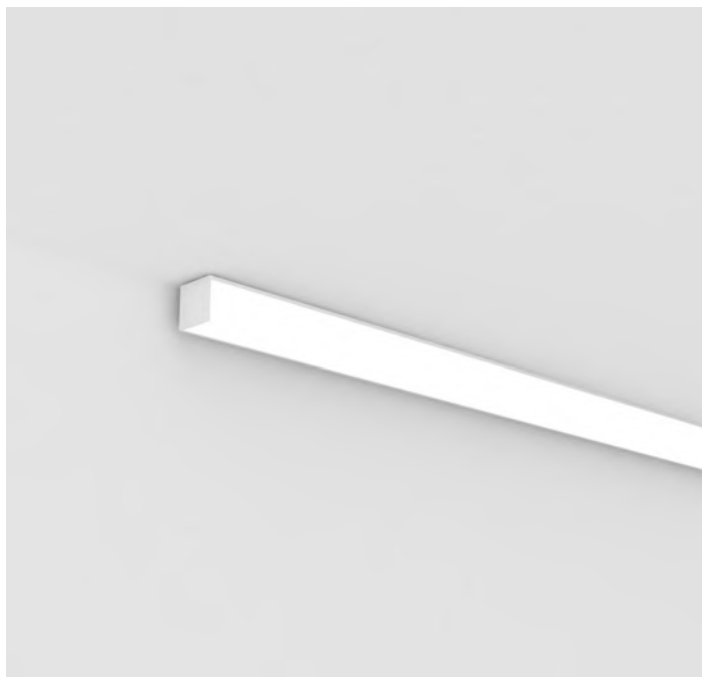
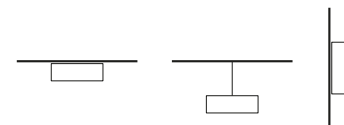

Physical Specifications		Physical Specifications		Options	
Structure	Extruded Aluminum	Finishing	Aluminum anodized/RAL	Length	On request
Reflector	N/A	Weight	-	Finish	RAL on request
Optical Cover	PC Opal	Body	Extruded Aluminum	Dimmable	On request
Fixation material	Aluminum/Stainless Steel	Diffuser	PC Opal	Trimless	N/A
Length	On request	UV Protection	Yes	Colour Temperature	2700K → 6000K
Width	30 mm			IP Rate	IP44
Height	30 mm				

Electrical Specifications		Performance		Remarks	
Input Voltage	220-240V	Power	4W-15W/m	Customized length	
Input Frequency	50-60 hz	Luminous Flux	400 lm-1500 lm/m	Angular shapes	
Dimmable	On request	Luminous flux tolerance	10%	RGB version	
Output	24V	Colour Temperature	2700 K → 6000 K		
IP Rate	IP20-IP67	Colour Rendering Index	≥80		
Power Factor	-	LED Luminaire Efficacy	100 lm/W		
Power	-				

PLD 340

WALK

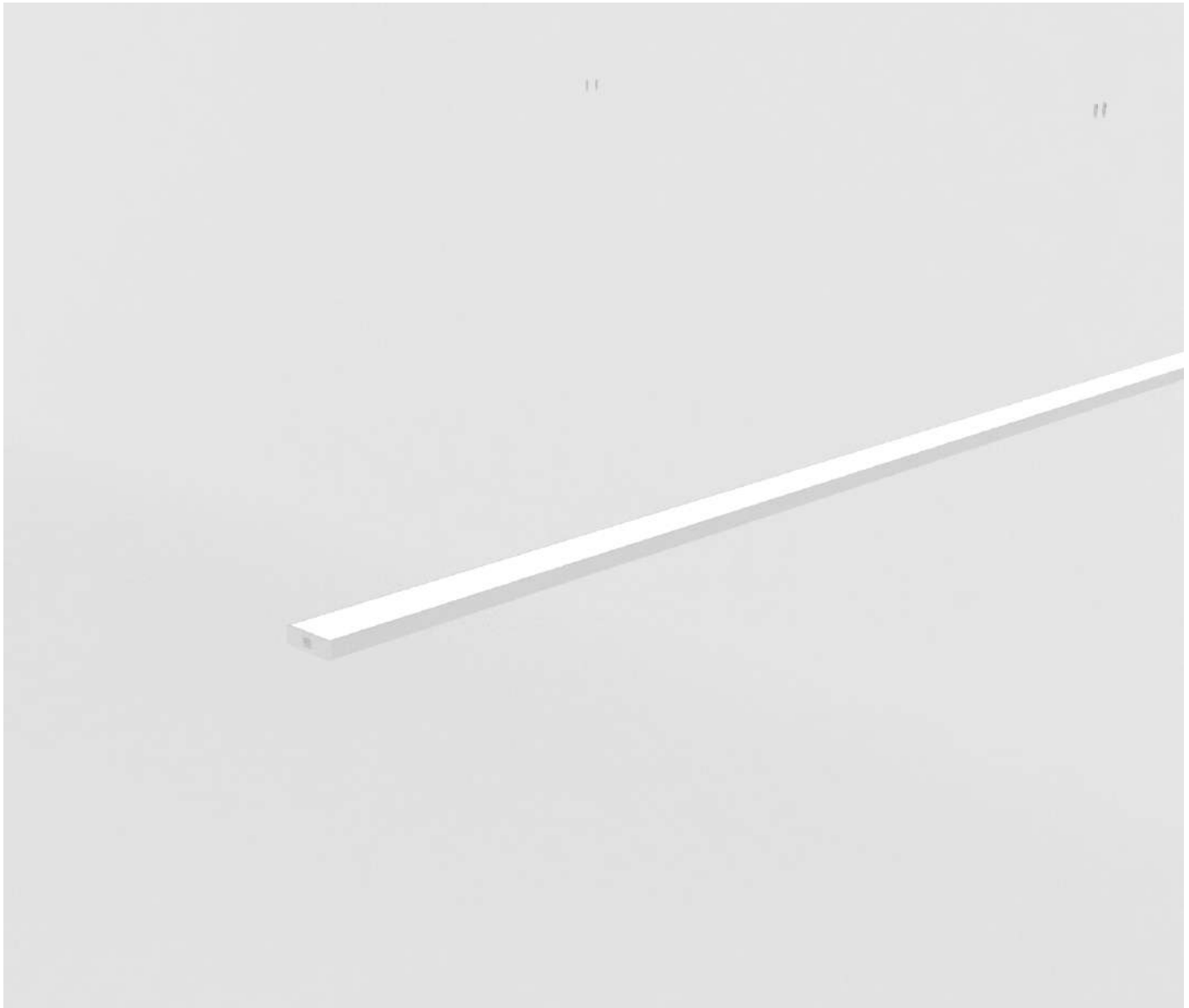

Product	
Code	PLD 340
Name	WALK
Categories	PROFIL
Subcategory	Linear
	Decorative
Type	Inground
Length	< 5 M
Finishing	RAL on request

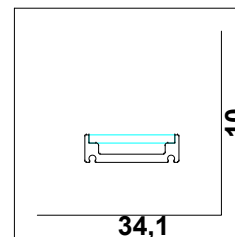

Product Specifications		General Information		Lamp Specifications	
Product Code	PLD 340	Suspension System	Inground	Lamp Type	LED
Body	Extruded Aluminum	Protection	IP40	LED Chip	Samsung
Number of light source	2	Installation	Indoor	Luminous Flux	110 lm/W
Light source color	2700 K → 6000 K	Mounting	Floor recessed	Power	4 W–20 W/m
Cap-Base	N/A	Trimless	N/A	Colour Temperature	2700 K → 6000 K
Light source replacable	Yes	Warranty Period	2 years	Length	2.5 cm → 50 cm
Luminaire light beam	120°			Width	0.8 cm

PLD 340

WALK

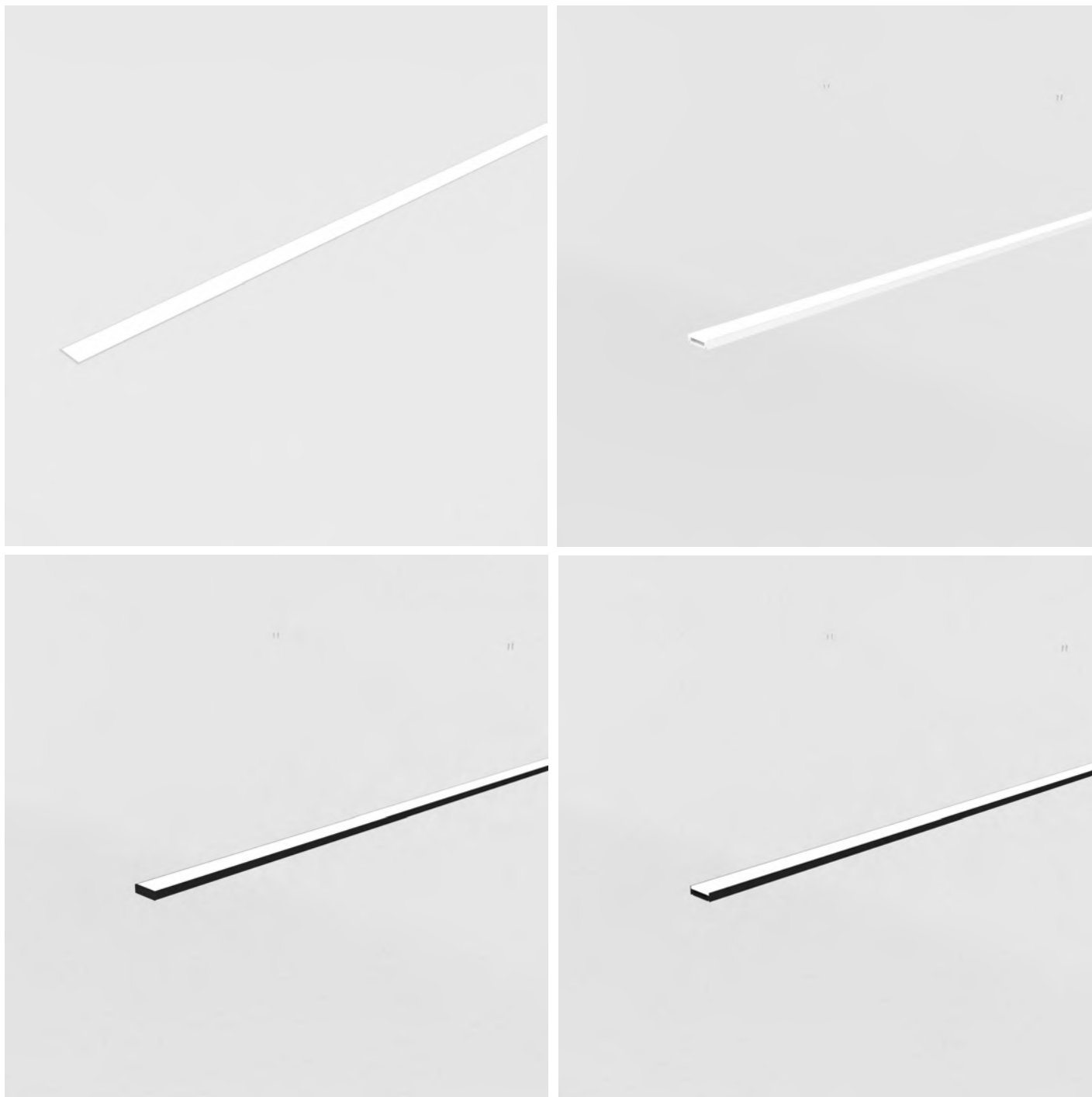

Physical Specifications		Physical Specifications		Options	
Structure	Extruded Aluminum	Finishing	Aluminum anodized/RAL	Length	On request
Reflector	N/A	Weight	–	Finish	RAL on request
Optical Cover	Plexiglass	Body	Extruded Aluminum	Dimmable	On request
Fixation material	Aluminum/Stainless Steel	Diffuser	Plexiglass	Trimless	N/A
Length	On request	UV Protection	Yes	Colour Temperature	2700K -> 6000K
Width	34.1 mm			IP Rate	IP44
Height	10 mm				

Electrical Specifications		Performance		Remarks	
Input Voltage	220–240V	Power	8W–20W/m	Customized length	
Input Frequency	50–60 hz	Luminous Flux	800 lm–2000 lm/m	Angular shapes	
Dimmable	On request	Luminous flux tolerance	10%	RGB version	
Output	24V	Colour Temperature	2700 K -> 6000 K		
IP Rate	IP20-IP67	Colour Rendering Index	≥80		
Power Factor	–	LED Luminaire Efficacy	100 lm/W		
Power	–				

PLD 320

CHARM

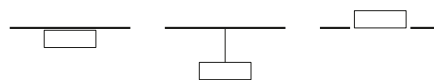

Product	
Code	PLD 320
Name	CHARM
Categories	PROFIL
Subcategory	Linear
	Decorative
Type	Pendant
	Ceiling lamp
	Trimless
Length	< 5 M
Finishing	RAL on request

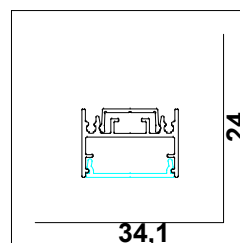

Product Specifications		General Information		Lamp Specifications	
Product Code	PLD 320	Suspension System	2 wire set	Lamp Type	LED
Body	Extruded Aluminum	Protection	IP40	LED Chip	Samsung
Number of light source	2	Installation	Indoor	Luminous Flux	110 lm/W
Light source color	2700 K → 6000 K	Mounting	Surface mounted/ Pendant	Power	4 W–20 W/m
Cap-Base	22 cm	Trimless	On request	Colour Temperature	2700 K → 6000 K
Light source replacable	Yes	Warranty Period	2 years	Length	2.5 cm → 50 cm
Luminaire light beam	120°			Width	0.8 cm

PLD 320

CHARM

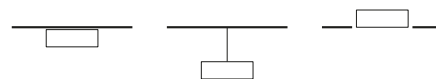

Physical Specifications		Physical Specifications		Options	
Structure	Extruded Aluminum	Finishing	Aluminum anodized/RAL	Length	On request
Reflector	N/A	Weight	–	Finish	RAL on request
Optical Cover	PC Opal/Microprismatic	Body	Extruded Aluminum	Dimmable	On request
Fixation material	Aluminum/Stainless Steel	Diffuser	PC Opal/Microprismatic	Trimless	On request
Length	On request	UV Protection	Yes	Colour Temperature	2700K → 6000K
Width	34.1 mm			IP Rate	IP44
Height	24 mm				
Electrical Specifications		Performance		Remarks	
Input Voltage	220–240V	Power	8W–30W/m	Customized length	
Input Frequency	50–60 Hz	Luminous Flux	800 lm–3000 lm/m	Angular shapes	
Dimmable	On request	Luminous flux tolerance	10%	RGB version	
Output	24V	Colour Temperature	2700 K → 6000 K		
IP Rate	IP20-IP67	Colour Rendering Index	≥80		
Power Factor	–	LED Luminaire Efficacy	100 lm/W		
Power	–				

PLD 300

LUMOS

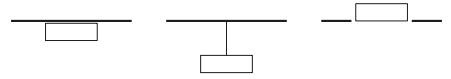

Product	
Code	PLD 300
Name	LUMOS
Categories	PROFIL
Subcategory	Linear
	Decorative
Type	Pendant
	Ceiling lamp
	Trimless
Length	< 5 M
Finishing	RAL on request

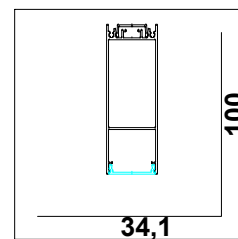

Product Specifications		General Information		Lamp Specifications	
Product Code	PLD 300	Suspension System	2 wire set	Lamp Type	LED
Body	Extruded Aluminum	Protection	IP40	LED Chip	Samsung
Number of light source	1	Installation	Indoor	Luminous Flux	110 lm/W
Light source color	2700 K -> 6000 K	Mounting	Surface mounted/ Pendant	Power	4 W-20 W/m
Cap-Base	6 cm	Trimless	On request	Colour Temperature	2700 K -> 6000 K
Light source replacable	Yes	Warranty Period	2 years	Length	2.5 cm -> 50 cm
Luminaire light beam	120°			Width	0.8 cm

PLD 300

LUMOS

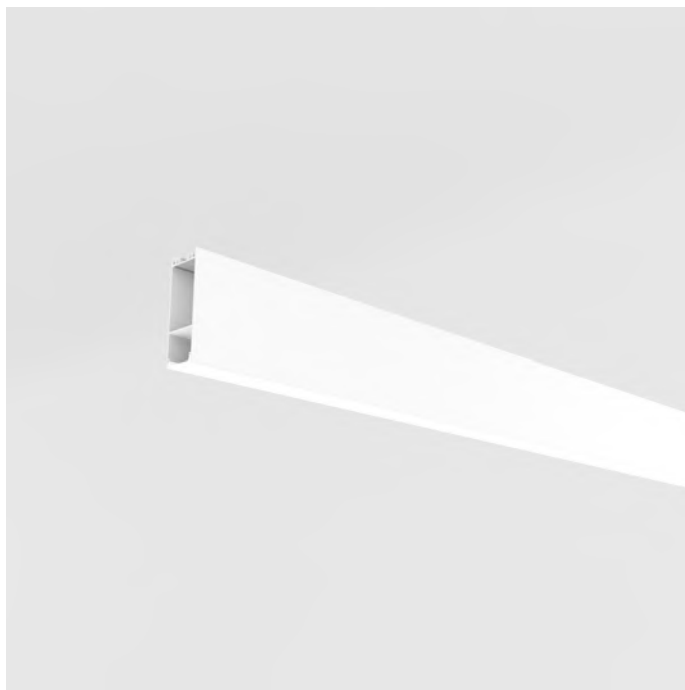
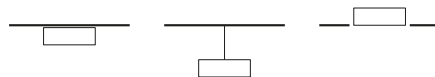

Physical Specifications		Physical Specifications		Options	
Structure	Extruded Aluminum	Finishing	Aluminum anodized/RAL	Length	On request
Reflector	N/A	Weight	-	Finish	RAL on request
Optical Cover	PC Opal/Microprismatic	Body	Extruded Aluminum	Dimmable	On request
Fixation material	Aluminum/Stainless Steel	Diffuser	PC Opal/Microprismatic	Trimless	On request
Length	On request	UV Protection	Yes	Colour Temperature	2700K → 6000K
Width	34.1 mm			IP Rate	IP44
Height	100 mm				

Electrical Specifications		Performance		Remarks	
Input Voltage	220-240V	Power	4W-20W/m	Customized length	
Input Frequency	50-60 hz	Luminous Flux	400 lm-2000 lm/m	Angular shapes	
Dimmable	On request	Luminous flux tolerance	10%	RGB version	
Output	24V	Colour Temperature	2700 K → 6000 K		
IP Rate	IP20-IP67	Colour Rendering Index	≥80		
Power Factor	-	LED Luminaire Efficacy	100 lm/W		
Power	-				

PLD 270

SUBLIM



Product	
Code	PLD 270
Name	SUBLIM
Categories	PROFIL
Subcategory	Linear
	Decorative
Type	Stair light
Length	< 5 M
Finishing	RAL on request

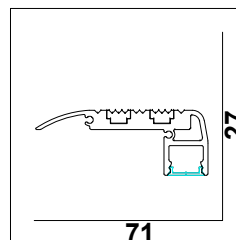

Product Specifications		General Information		Lamp Specifications	
Product Code	PLD 270	Suspension System	N/A	Lamp Type	LED
Body	Extruded Aluminum	Protection	IP40	LED Chip	Samsung
Number of light source	1	Installation	Indoor	Luminous Flux	110 lm/W
Light source color	2700 K -> 6000 K	Mounting	Surface mounted	Power	4 W-20 W/m
Cap-Base	N/A	Trimless	N/A	Colour Temperature	2700 K -> 6000 K
Light source replacable	Yes	Warranty Period	2 years	Length	2.5 cm -> 50 cm
Luminaire light beam	120°			Width	0.8 cm

PLD 270

SUBLIM



Physical Specifications		Physical Specifications		Options	
Structure	Extruded Aluminum	Finishing	Aluminum anodized/RAL	Length	On request
Reflector	N/A	Weight	–	Finish	RAL on request
Optical Cover	PC Opal	Body	Extruded Aluminum	Dimmable	On request
Fixation material	Aluminum/Stainless Steel	Diffuser	PC Opal	Trimless	N/A
Length	On request	UV Protection	Yes	Colour Temperature	2700K → 6000K
Width	71 mm			IP Rate	IP44
Height	27 mm				

Electrical Specifications		Performance		Remarks	
Input Voltage	220–240V	Power	4W–15W/m	Customized length	
Input Frequency	50–60 Hz	Luminous Flux	400 lm–1500 lm/m	Angular shapes	
Dimmable	On request	Luminous flux tolerance	10%	RGB version	
Output	24V	Colour Temperature	2700 K → 6000 K		
IP Rate	IP20-IP67	Colour Rendering Index	≥80		
Power Factor	–	LED Luminaire Efficacy	100 lm/W		
Power	–				

PLD 261

MATRIX



Product	
Code	PLD 261
Name	MATRIX
Categories	PROFIL
Subcategory	Linear
	Decorative
Type	Pendant
	Ceiling lamp
Length	< 5 M
Finishing	RAL on request

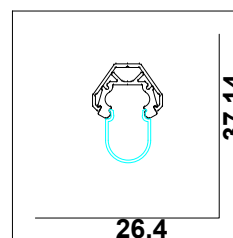

Product Specifications		General Information		Lamp Specifications	
Product Code	PLD 261	Suspension System	2 wire set	Lamp Type	LED
Body	Extruded Aluminum	Protection	IP40	LED Chip	Samsung
Number of light source	1	Installation	Indoor	Luminous Flux	110 lm/W
Light source color	2700 K -> 6000 K	Mounting	Surface mounted/ Pendant	Power	4 W-20 W/m
Cap-Base	22 cm	Trimless	N/A	Colour Temperature	2700 K -> 6000 K
Light source replacable	Yes	Warranty Period	2 years	Length	2.5 cm -> 50 cm
Luminaire light beam	120°			Width	0.8 cm

PLD 261

MATRIX

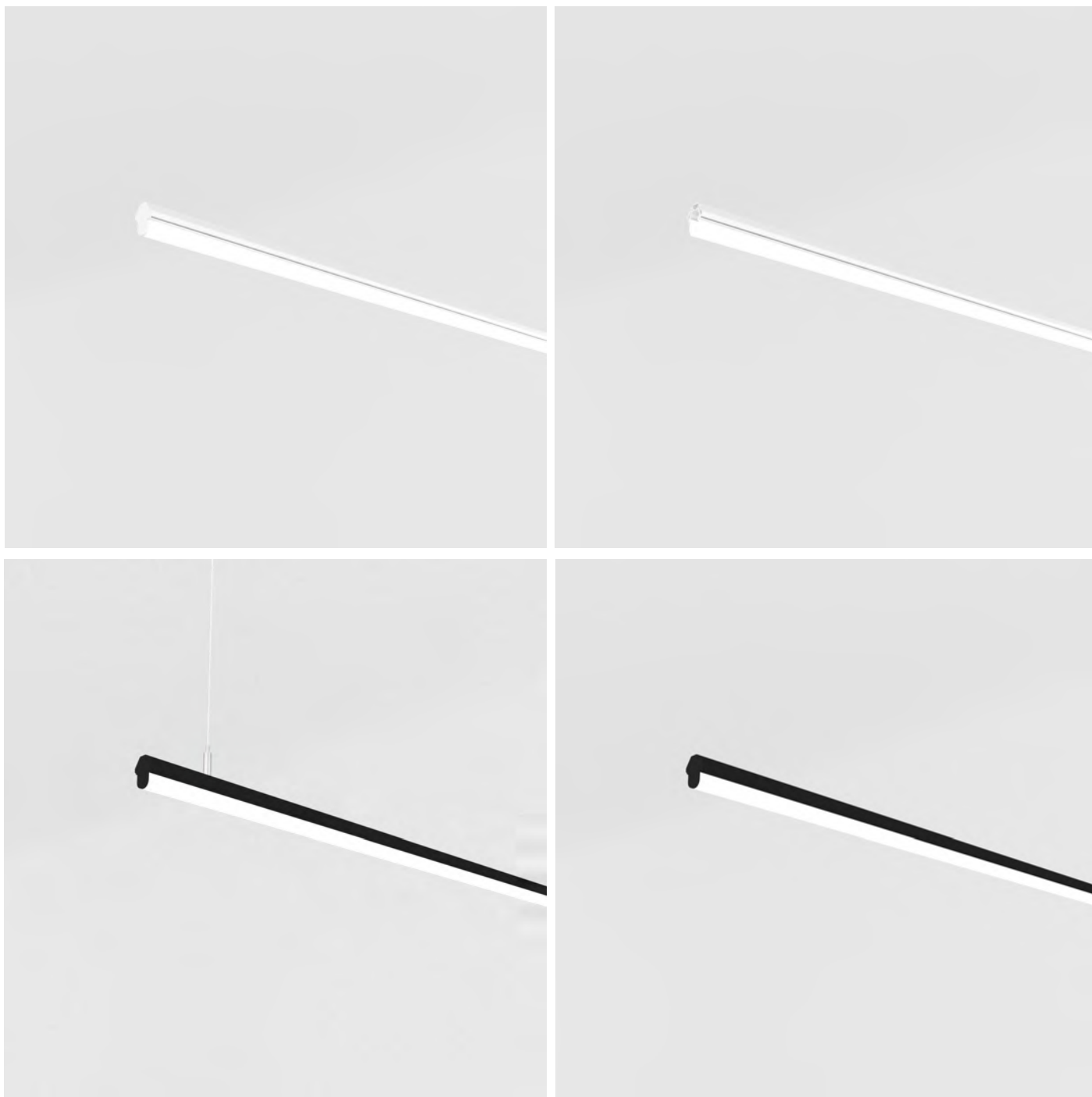
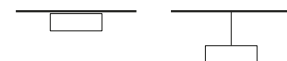

Physical Specifications		Physical Specifications		Options	
Structure	Extruded Aluminum	Finishing	Aluminum anodized/RAL	Length	On request
Reflector	N/A	Weight	-	Finish	RAL on request
Optical Cover	PC Opal	Body	Extruded Aluminum	Dimmable	On request
Fixation material	Aluminum/Stainless Steel	Diffuser	PC Opal	Trimless	N/A
Length	On request	UV Protection	Yes	Colour Temperature	2700K → 6000K
Width	26.4 mm			IP Rate	IP44
Height	37.14 mm				

Electrical Specifications		Performance		Remarks	
Input Voltage	220-240V	Power	4W-15W/m	Customized length	
Input Frequency	50-60 hz	Luminous Flux	400 lm-1500 lm/m	Angular shapes	
Dimmable	On request	Luminous flux tolerance	10%	RGB version	
Output	24V	Colour Temperature	2700 K → 6000 K		
IP Rate	IP20-IP67	Colour Rendering Index	≥80		
Power Factor	-	LED Luminaire Efficacy	100 lm/W		
Power	-				

PLD 260

MINI



Product	
Code	PLD 260
Name	MINI
Categories	PROFIL
Subcategory	Linear
	Decorative
Type	Pendant
	Ceiling lamp
Length	< 5 M
Finishing	RAL on request

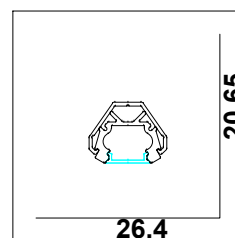

Product Specifications		General Information		Lamp Specifications	
Product Code	PLD 260	Suspension System	2 wire set	Lamp Type	LED
Body	Extruded Aluminum	Protection	IP40	LED Chip	Samsung
Number of light source	1	Installation	Indoor	Luminous Flux	110 lm/W
Light source color	2700 K → 6000 K	Mounting	Surface mounted/ Pendant	Power	4 W–20 W/m
Cap-Base	22 cm	Trimless	N/A	Colour Temperature	2700 K → 6000 K
Light source replacable	Yes	Warranty Period	2 years	Length	2.5 cm → 50 cm
Luminaire light beam	120°			Width	0.8 cm

PLD 260

MINI

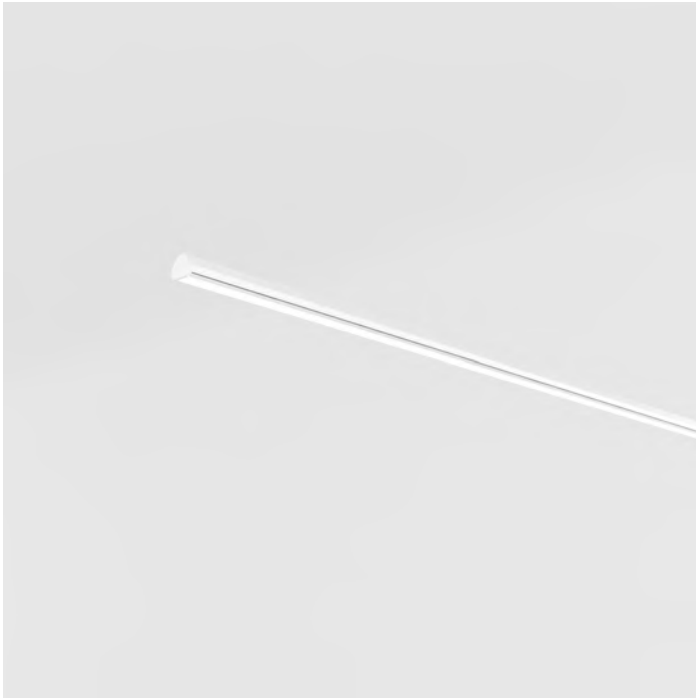
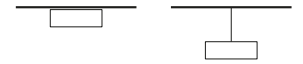

Physical Specifications		Physical Specifications		Options	
Structure	Extruded Aluminum	Finishing	Aluminum anodized/RAL	Length	On request
Reflector	N/A	Weight	-	Finish	RAL on request
Optical Cover	PC Opal	Body	Extruded Aluminum	Dimmable	On request
Fixation material	Aluminum/Stainless Steel	Diffuser	PC Opal	Trimless	N/A
Length	On request	UV Protection	Yes	Colour Temperature	2700K -> 6000K
Width	26.4 mm			IP Rate	IP44
Height	20.65 mm				

Electrical Specifications		Performance		Remarks	
Input Voltage	220-240V	Power	4W-15W/m	Customized length	
Input Frequency	50-60 hz	Luminous Flux	400 lm-1500 lm/m	Angular shapes	
Dimmable	On request	Luminous flux tolerance	10%	RGB version	
Output	24V	Colour Temperature	2700 K -> 6000 K		
IP Rate	IP20-IP67	Colour Rendering Index	≥80		
Power Factor	-	LED Luminaire Efficacy	100 lm/W		
Power	-				

PLD 230

TRIMA

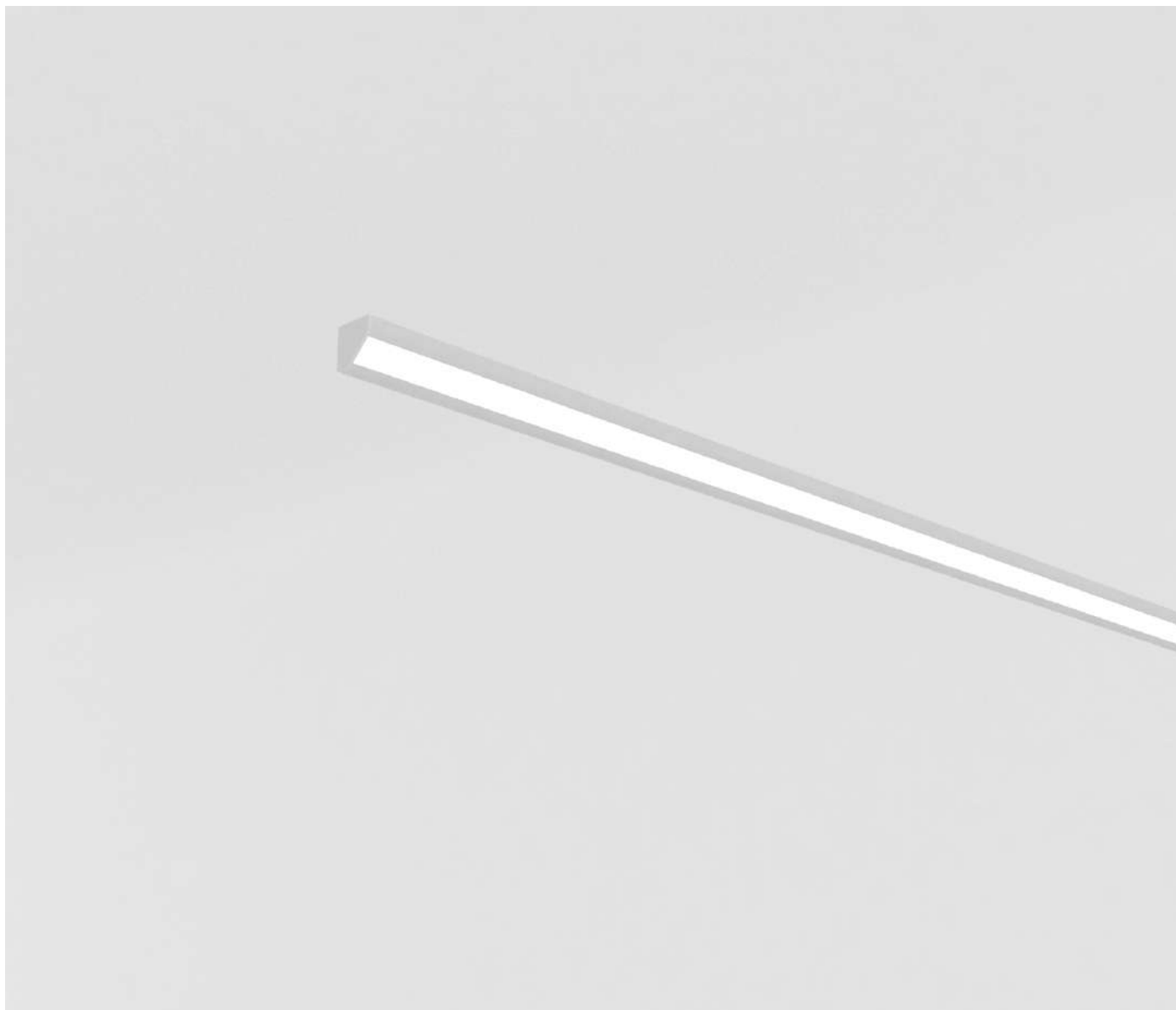

Product	
Code	PLD 230
Name	TRIMA
Categories	PROFIL
Subcategory	Linear
Type	Decorative
Lenght	< 5 M
Finishing	RAL on request

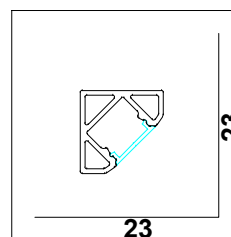

Product Specifications		General Information		Lamp Specifications	
Product Code	PLD 230	Suspension System	N/A	Lamp Type	LED
Body	Extruded Aluminum	Protection	IP40	LED Chip	Samsung
Number of light source	1	Installation	Indoor	Luminous Flux	110 lm/W
Light source color	2700 K → 6000 K	Mounting	Surface mounted	Power	4 W–20 W/m
Cap-Base	N/A	Trimless	N/A	Colour Temperature	2700 K → 6000 K
Light source replacable	Yes	Warranty Period	2 years	Length	2.5 cm → 50 cm
Luminaire light beam	120°			Width	0.8 cm

PLD 230

TRIMA



Physical Specifications		Physical Specifications		Options	
Structure	Extruded Aluminum	Finishing	Aluminum anodized/RAL	Length	On request
Reflector	N/A	Weight	-	Finish	RAL on request
Optical Cover	PC Opal	Body	Extruded Aluminum	Dimmable	On request
Fixation material	Aluminum/Stainless Steel	Diffuser	PC Opal	Trimless	N/A
Length	On request	UV Protection	Yes	Colour Temperature	2700K → 6000K
Width	23 mm			IP Rate	IP44
Height	23 mm				

Electrical Specifications		Performance		Remarks	
Input Voltage	220-240V	Power	4W-15W/m	Customized length	
Input Frequency	50-60 hz	Luminous Flux	400 lm-1500 lm/m	Angular shapes	
Dimmable	On request	Luminous flux tolerance	10%	RGB version	
Output	24V	Colour Temperature	2700 K → 6000 K		
IP Rate	IP20-IP67	Colour Rendering Index	≥80		
Power Factor	-	LED Luminaire Efficacy	100 lm/W		
Power	-				

PLD 220

SMOTHIE

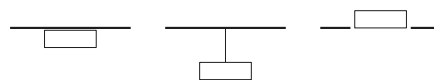

Product	
Code	PLD 220
Name	SMOTHIE
Categories	PROFIL
Subcategory	Linear
	Decorative
Type	Pendant
	Ceiling lamp
	Trimless
Lenght	< 5 M
Finishing	RAL on request

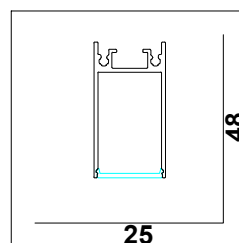

Product Specifications		General Information		Lamp Specifications	
Product Code	PLD 220	Suspension System	2 wire set	Lamp Type	LED
Body	Extruded Aluminum	Protection	IP40	LED Chip	Samsung
Number of light source	1	Installation	Indoor	Luminous Flux	110 lm/W
Light source color	2700 K → 6000 K	Mounting	Surface mounted/ Pendant	Power	4 W-20 W/m
Cap-Base	22 cm	Trimless	On request	Colour Temperature	2700 K → 6000 K
Light source replacable	Yes	Warranty Period	2 years	Length	2.5 cm → 50 cm
Luminaire light beam	120°			Width	0.8 cm

PLD 220

SMOTHIE

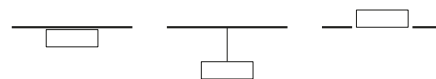

Physical Specifications		Physical Specifications		Options	
Structure	Extruded Aluminum	Finishing	Aluminum anodized/RAL	Length	On request
Reflector	N/A	Weight	-	Finish	RAL on request
Optical Cover	PC Opal	Body	Extruded Aluminum	Dimmable	On request
Fixation material	Aluminum/Stainless Steel	Diffuser	PC Opal	Trimless	On request
Length	On request	UV Protection	Yes	Colour Temperature	2700K → 6000K
Width	25 mm			IP Rate	IP44
Height	48 mm				
Electrical Specifications		Performance		Remarks	
Input Voltage	220-240V	Power	4W-20W/m	Customized length	
Input Frequency	50-60 hz	Luminous Flux	400 lm-2000 lm/m	Angular shapes	
Dimmable	On request	Luminous flux tolerance	10%	RGB version	
Output	24V	Colour Temperature	2700 K → 6000 K		
IP Rate	IP20-IP67	Colour Rendering Index	≥80		
Power Factor	-	LED Luminaire Efficacy	100 lm/W		
Power	-				

PLD 200

TIRA

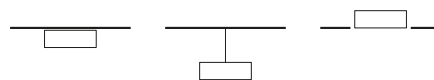

Product	
Code	PLD 200
Name	TIRA
Categories	PROFIL
Subcategory	Linear
	Decorative
Type	Pendant
	Ceiling lamp
	Trimless
Length	< 5 M
Finishing	RAL on request

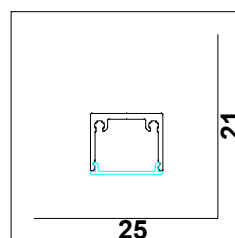

Product Specifications		General Information		Lamp Specifications	
Product Code	PLD 200	Suspension System	2 wire set	Lamp Type	LED
Body	Extruded Aluminum	Protection	IP40	LED Chip	Samsung
Number of light source	1	Installation	Indoor	Luminous Flux	110 lm/W
Light source color	2700 K → 6000 K	Mounting	Surface mounted/ Pendant	Power	4 W–20 W/m
Cap-Base	22 cm	Trimless	On request	Colour Temperature	2700 K → 6000 K
Light source replacable	Yes	Warranty Period	2 years	Length	2.5 cm → 50 cm
Luminaire light beam	120°			Width	0.8 cm

PLD 200

TIRA

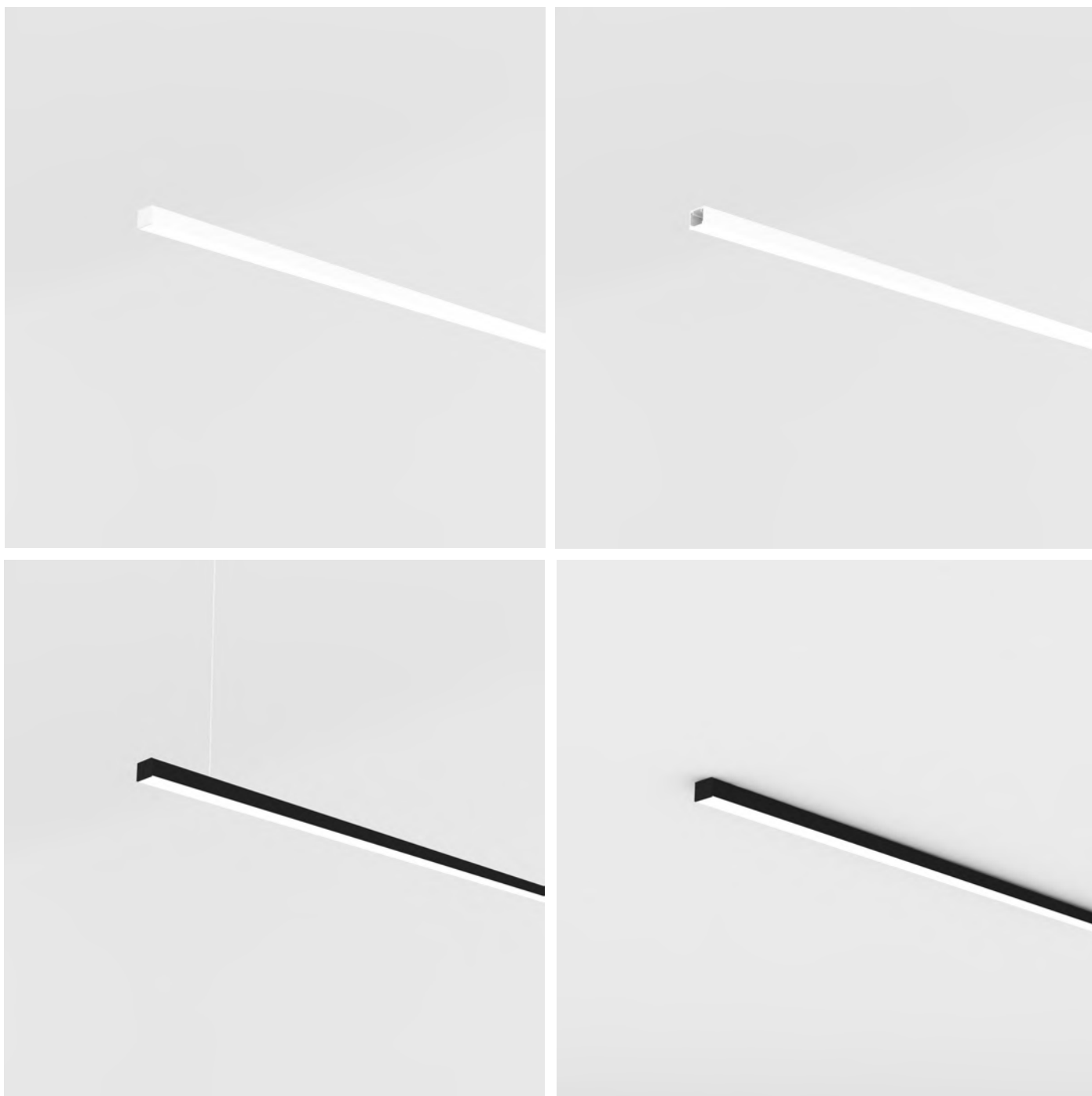
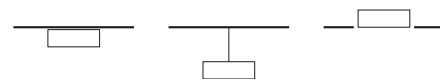

Physical Specifications		Physical Specifications		Options	
Structure	Extruded Aluminum	Finishing	Aluminum anodized/RAL	Length	On request
Reflector	N/A	Weight	-	Finish	RAL on request
Optical Cover	PC Opal	Body	Extruded Aluminum	Dimmable	On request
Fixation material	Aluminum/Stainless Steel	Diffuser	PC Opal	Trimless	On request
Length	On request	UV Protection	Yes	Colour Temperature	2700K -> 6000K
Width	25 mm			IP Rate	IP44
Height	21 mm				

Electrical Specifications		Performance		Remarks	
Input Voltage	220-240V	Power	4W-20W/m	Customized length	
Input Frequency	50-60 hz	Luminous Flux	400 lm-2000 lm/m	Angular shapes	
Dimmable	On request	Luminous flux tolerance	10%	RGB version	
Output	24V	Colour Temperature	2700 K -> 6000 K		
IP Rate	IP20-IP67	Colour Rendering Index	≥80		
Power Factor	-	LED Luminaire Efficacy	100 lm/W		
Power	-				

PLD 131

BALA



Product	
Code	PLD 131
Name	BALA
Categories	PROFIL
Subcategory	Linear
Type	Decorative
Length	Ceiling recessed
Finishing	< 5 M
	RAL on request

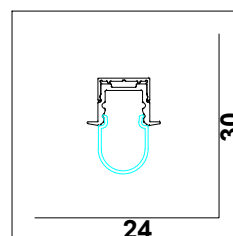

Product Specifications		General Information		Lamp Specifications	
Product Code	PLD 131	Suspension System	N/A	Lamp Type	LED
Body	Extruded Aluminum	Protection	IP40	LED Chip	Samsung
Number of light source	1	Installation	Indoor	Luminous Flux	110 lm/W
Light source color	2700 K → 6000 K	Mounting	Recessed with springs	Power	4 W–20 W/m
Cap-Base	N/A	Trimless	N/A	Colour Temperature	2700 K → 6000 K
Light source replacable	Yes	Warranty Period	2 years	Length	2.5 cm → 50 cm
Luminaire light beam	120°			Width	0.8 cm

PLD 131

BALA

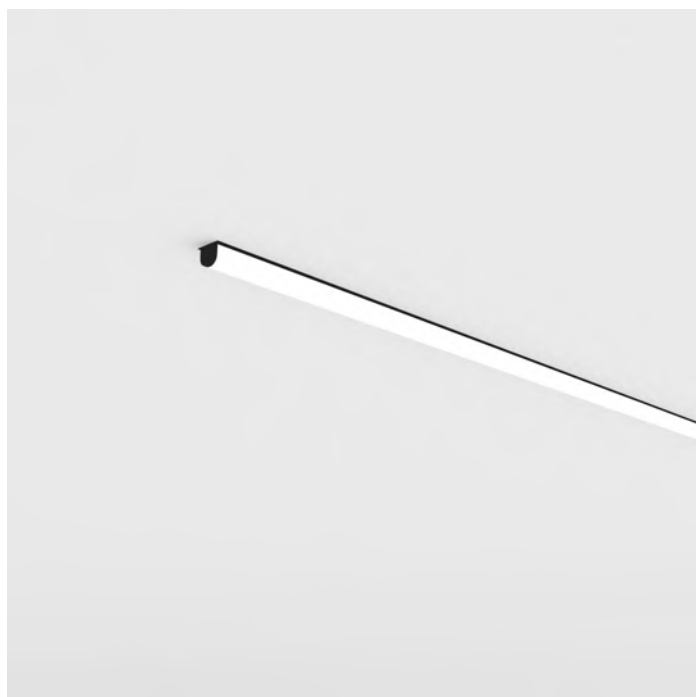
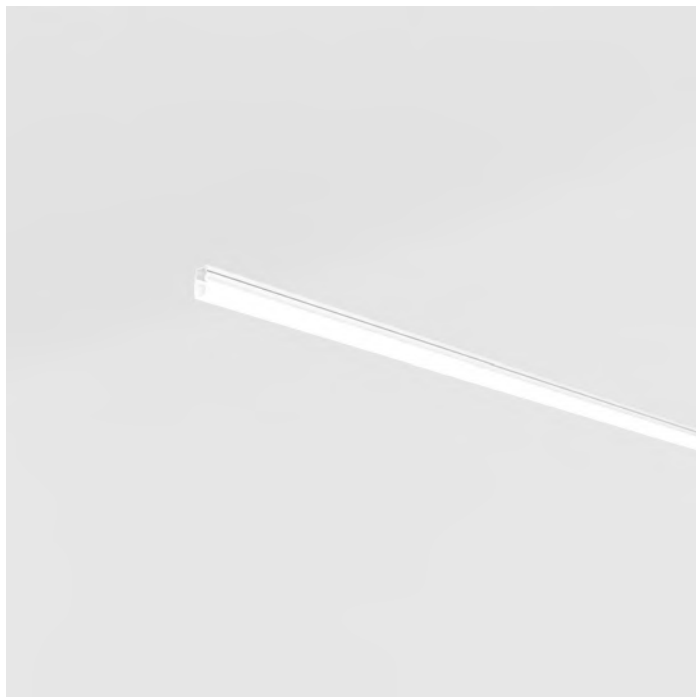
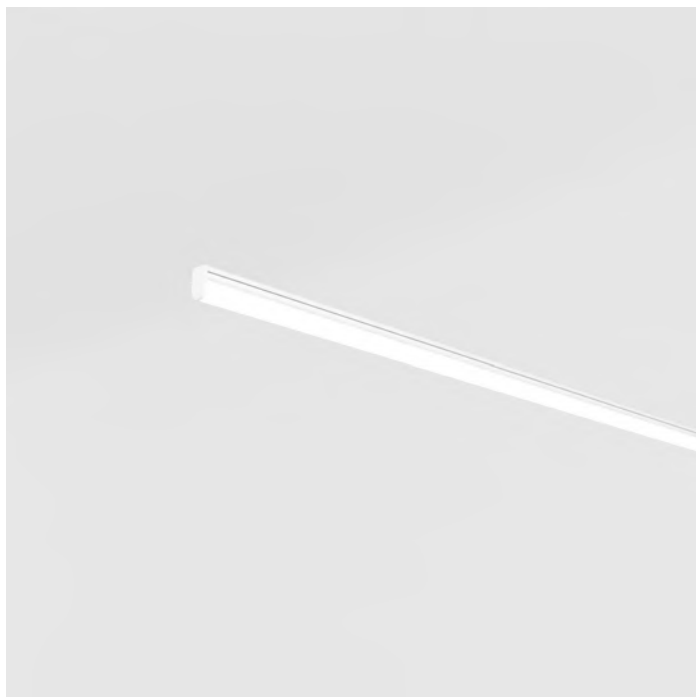

Physical Specifications		Physical Specifications		Options	
Structure	Extruded Aluminum	Finishing	Aluminum anodized/RAL	Length	On request
Reflector	N/A	Weight	–	Finish	RAL on request
Optical Cover	PC Opal	Body	Extruded Aluminum	Dimmable	On request
Fixation material	Aluminum/Stainless Steel	Diffuser	PC Opal	Trimless	N/A
Length	On request	UV Protection	Yes	Colour Temperature	2700K → 6000K
Width	24 mm			IP Rate	IP44
Height	30 mm				

Electrical Specifications		Performance		Remarks	
Input Voltage	220–240V	Power	4W–15W/m	Customized length	
Input Frequency	50–60 hz	Luminous Flux	400 lm–1500 lm/m	Angular shapes	
Dimmable	On request	Luminous flux tolerance	10%	RGB version	
Output	24V	Colour Temperature	2700 K → 6000 K		
IP Rate	IP20-IP67	Colour Rendering Index	≥80		
Power Factor	–	LED Luminaire Efficacy	100 lm/W		
Power	–				

PLD 130

BOA

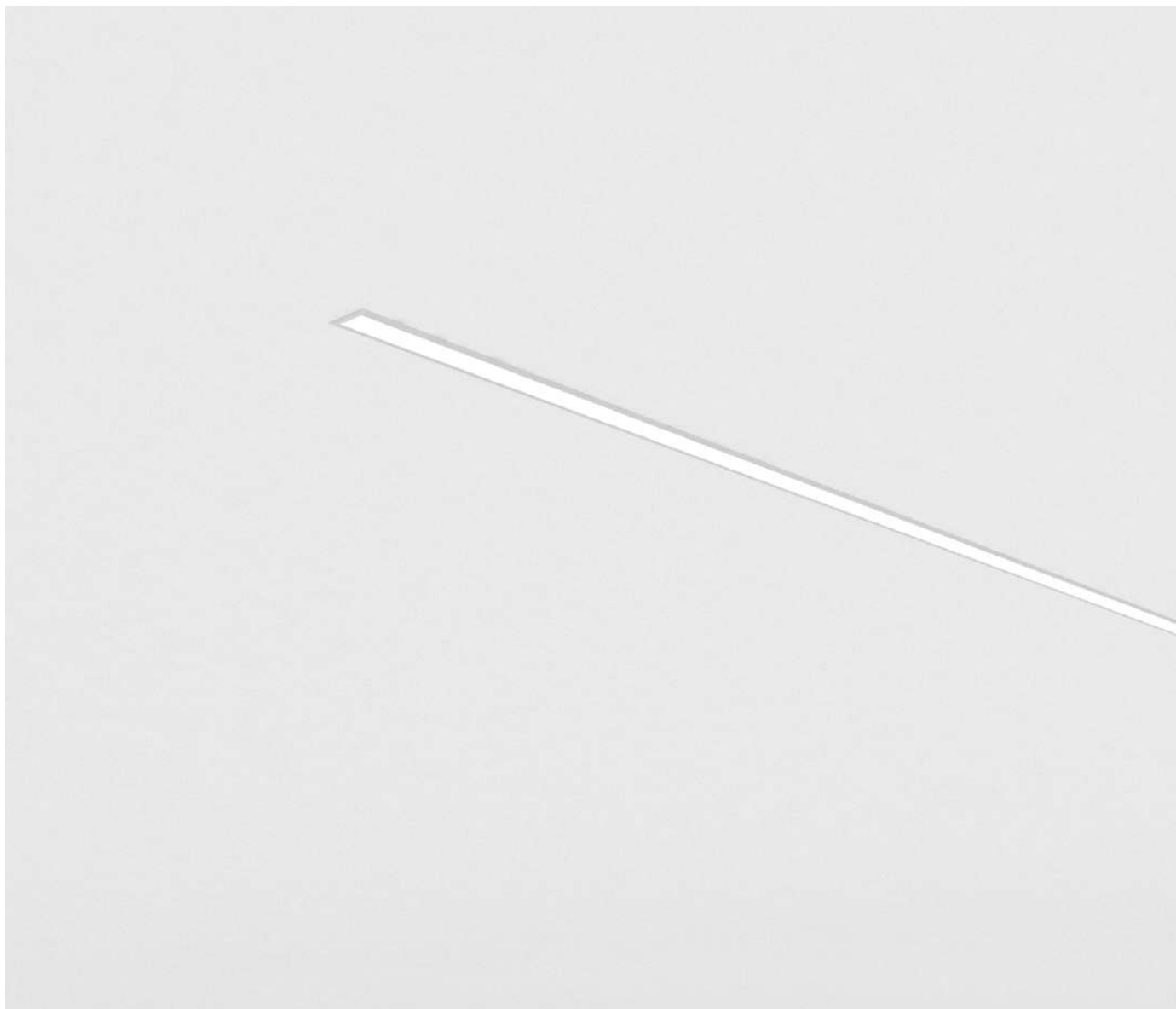

Product	
Code	PLD 130
Name	BOA
Categories	PROFIL
Subcategory	Linear
Type	Decorative
	Ceiling recessed
Length	< 5 M
Finishing	RAL on request

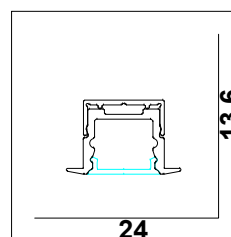

Product Specifications		General Information		Lamp Specifications	
Product Code	PLD 130	Suspension System	N/A	Lamp Type	LED
Body	Extruded Aluminum	Protection	IP40	LED Chip	Samsung
Number of light source	1	Installation	Indoor	Luminous Flux	110 lm/W
Light source color	2700 K → 6000 K	Mounting	Recessed with springs	Power	4 W–20 W/m
Cap-Base	N/A	Trimless	N/A	Colour Temperature	2700 K → 6000 K
Light source replacable	Yes	Warranty Period	2 years	Length	2.5 cm → 50 cm
Luminaire light beam	120°			Width	0.8 cm

PLD 130

BOA

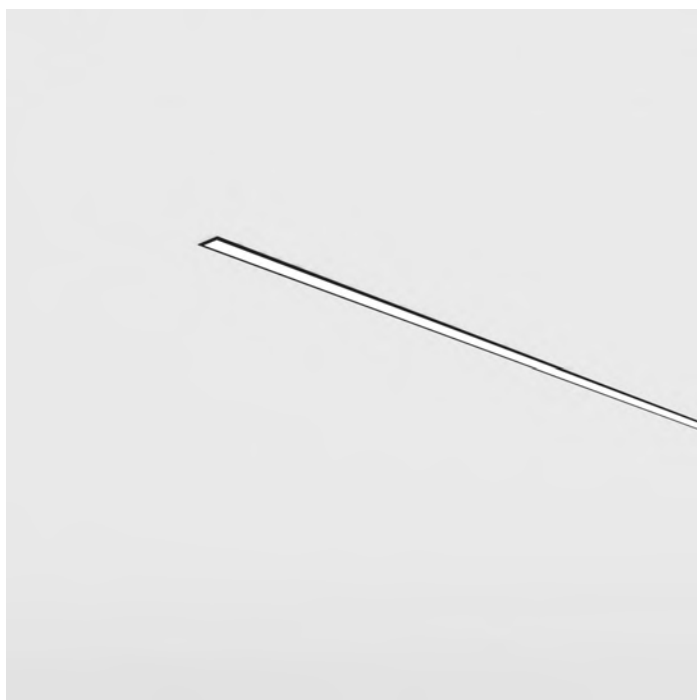

Physical Specifications		Physical Specifications		Options	
Structure	Extruded Aluminum	Finishing	Aluminum anodized/RAL	Length	On request
Reflector	N/A	Weight	-	Finish	RAL on request
Optical Cover	PC Opal	Body	Extruded Aluminum	Dimmable	On request
Fixation material	Aluminum/Stainless Steel	Diffuser	PC Opal	Trimless	N/A
Length	On request	UV Protection	Yes	Colour Temperature	2700K -> 6000K
Width	24 mm			IP Rate	IP44
Height	13.6 mm				

Electrical Specifications		Performance		Remarks	
Input Voltage	220-240V	Power	4W-15W/m	Customized length	
Input Frequency	50-60 hz	Luminous Flux	400 lm-1500 lm/m	Angular shapes	
Dimmable	On request	Luminous flux tolerance	10%	RGB version	
Output	24V	Colour Temperature	2700 K -> 6000 K		
IP Rate	IP20-IP67	Colour Rendering Index	≥80		
Power Factor	-	LED Luminaire Efficacy	100 lm/W		
Power	-				

PLD 110

LINER

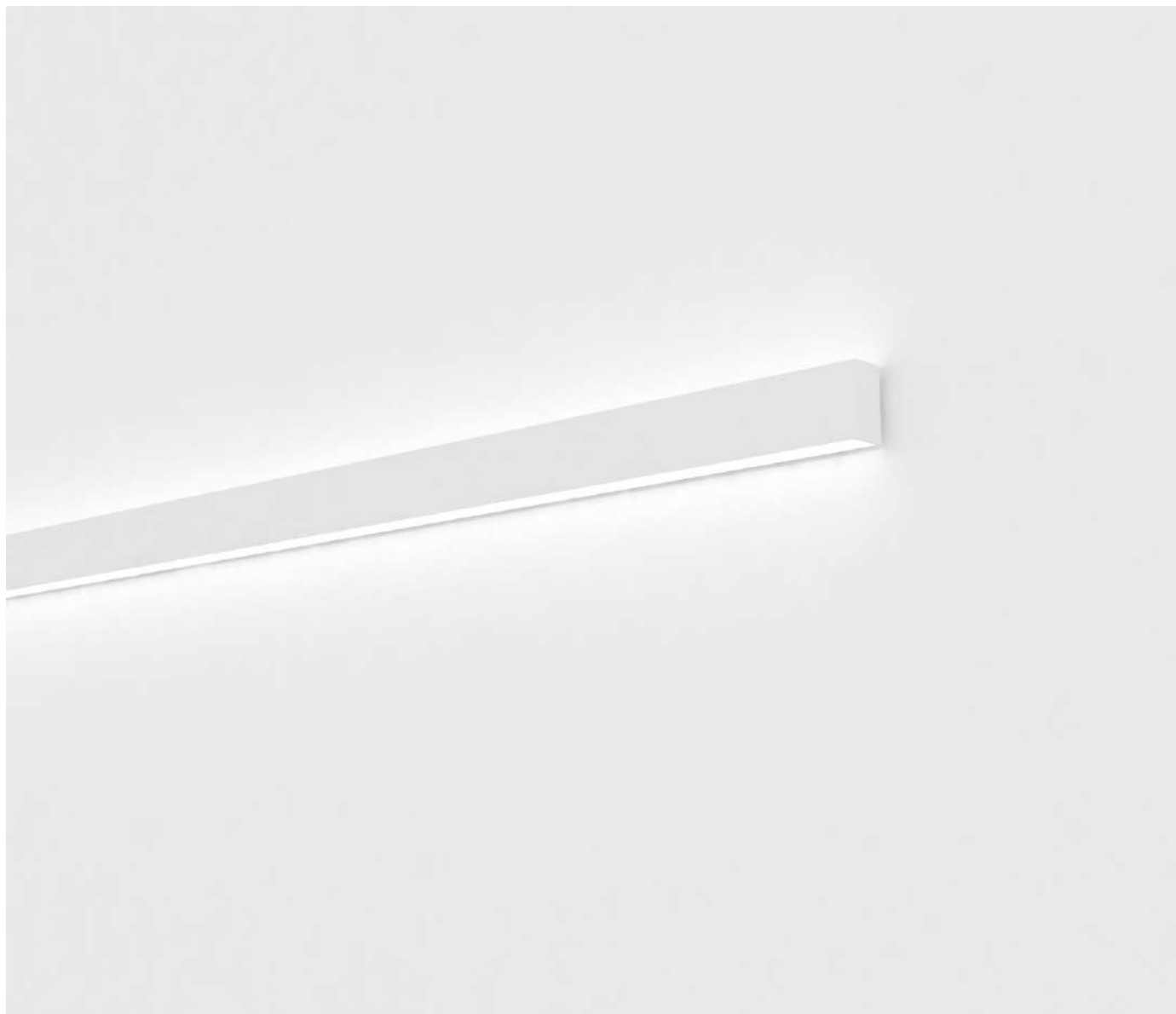
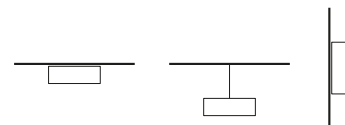

Product	
Code	PLD 110
Name	LINER
Categories	PROFIL
Subcategory	Linear
Type	Decorative Pendant
	Wall lamp Ceiling lamp
Length	< 5 M
Finishing	RAL on request

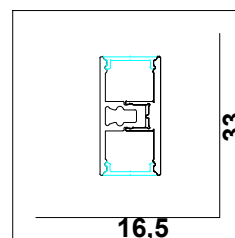

Product Specifications	General Information	Lamp Specifications
Product Code	PLD 110	Suspension System
Body	Extruded Aluminum	Protection
Number of light source	2	Installation
Light source color	2700 K -> 6000 K	Mounting
Cap-Base	N/A	Trimless
Light source replacable	Yes	Warranty Period
Luminaire light beam	120°	
		Lamp Type
		LED Chip
		Luminous Flux
		Power
		Colour Temperature
		Length
		Width

PLD 110

LINER

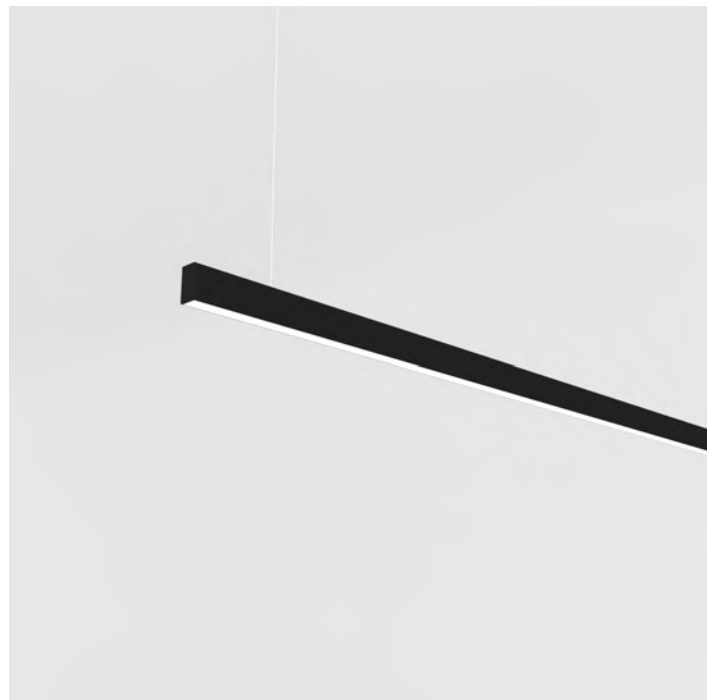
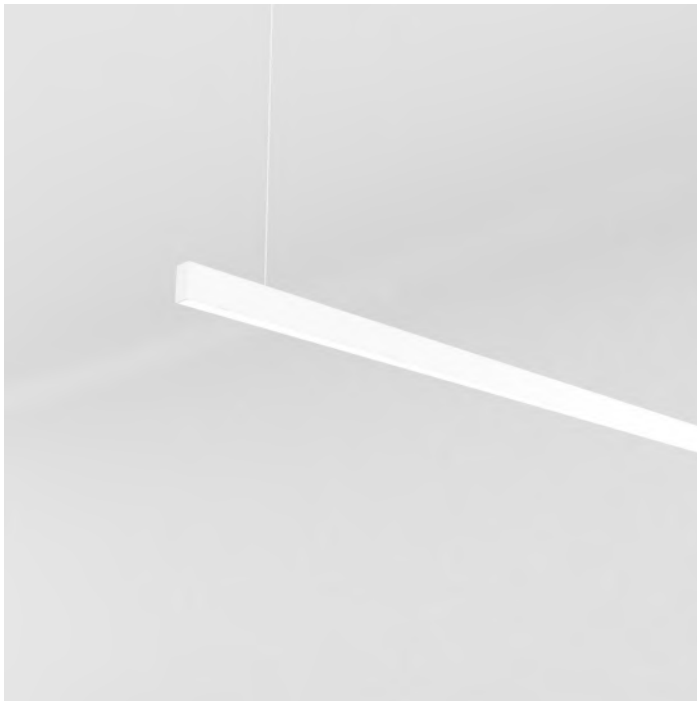
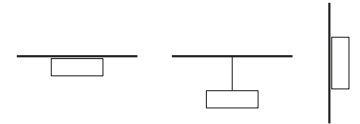

Physical Specifications		Physical Specifications		Options	
Structure	Extruded Aluminum	Finishing	Aluminum anodized/RAL	Length	On request
Reflector	N/A	Weight	-	Finish	RAL on request
Optical Cover	PC Opal	Body	Extruded Aluminum	Dimmable	On request
Fixation material	Aluminum/Stainless Steel	Diffuser	PC Opal	Trimless	N/A
Length	On request	UV Protection	Yes	Colour Temperature	2700K → 6000K
Width	16.5 mm			IP Rate	IP44
Height	33 mm				

Electrical Specifications		Performance		Remarks	
Input Voltage	220-240V	Power	8W-30W/m	Customized length	
Input Frequency	50-60 hz	Luminous Flux	800 lm-3000 lm/m	Angular shapes	
Dimmable	On request	Luminous flux tolerance	10%	RGB version	
Output	24V	Colour Temperature	2700 K → 6000 K		
IP Rate	IP20-IP67	Colour Rendering Index	≥80		
Power Factor	-	LED Luminaire Efficacy	100 lm/W		
Power	-				

PLD 101

TORO

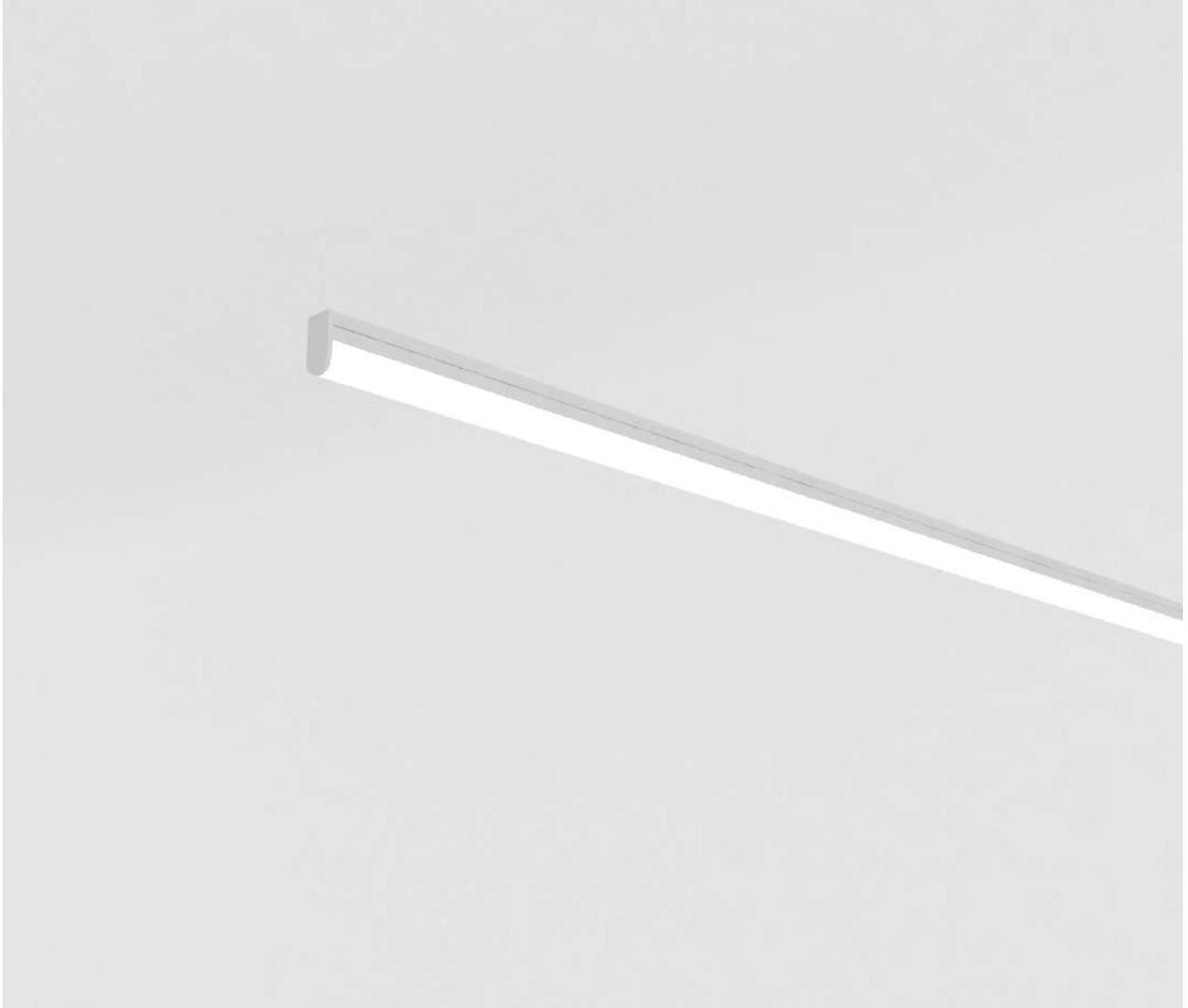

Product	
Code	PLD 101
Name	TORO
Categories	PROFIL
Subcategory	Linear
Type	Decorative
	Pendant
	Ceiling lamp
Length	< 5 M
Finishing	RAL on request

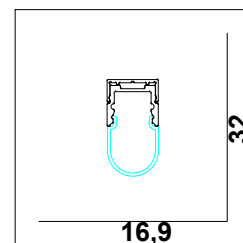

Product Specifications		General Information		Lamp Specifications	
Product Code	PLD 101	Suspension System	2 wire set	Lamp Type	LED
Body	Extruded Aluminum	Protection	IP40	LED Chip	Samsung
Number of light source	1	Installation	Indoor	Luminous Flux	110 lm/W
Light source color	2700 K → 6000 K	Mounting	Surface mounted/ Pendant	Power	4 W–20 W/m
Cap-Base	N/A	Trimless	N/A	Colour Temperature	2700 K → 6000 K
Light source replacable	Yes	Warranty Period	2 years	Length	2.5 cm → 50 cm
Luminaire light beam	120°			Width	0.8 cm

PLD 101

TORO



Physical Specifications		Physical Specifications		Options	
Structure	Extruded Aluminum	Finishing	Aluminum anodized/RAL	Length	On request
Reflector	N/A	Weight	-	Finish	RAL on request
Optical Cover	PC Opal	Body	Extruded Aluminum	Dimmable	On request
Fixation material	Aluminum/Stainless Steel	Diffuser	PC Opal	Trimless	N/A
Length	On request	UV Protection	Yes	Colour Temperature	2700K -> 6000K
Width	16.9 mm			IP Rate	IP44
Height	30 mm				

Electrical Specifications		Performance		Remarks	
Input Voltage	220-240V	Power	4W-15W/m	Customized length	
Input Frequency	50-60 hz	Luminous Flux	400 lm-1500 lm/m	Angular shapes	
Dimmable	On request	Luminous flux tolerance	10%	RGB version	
Output	24V	Colour Temperature	2700 K -> 6000 K		
IP Rate	IP20-IP67	Colour Rendering Index	≥80		
Power Factor	-	LED Luminaire Efficacy	100 lm/W		
Power	-				

PLD 100

TOBY

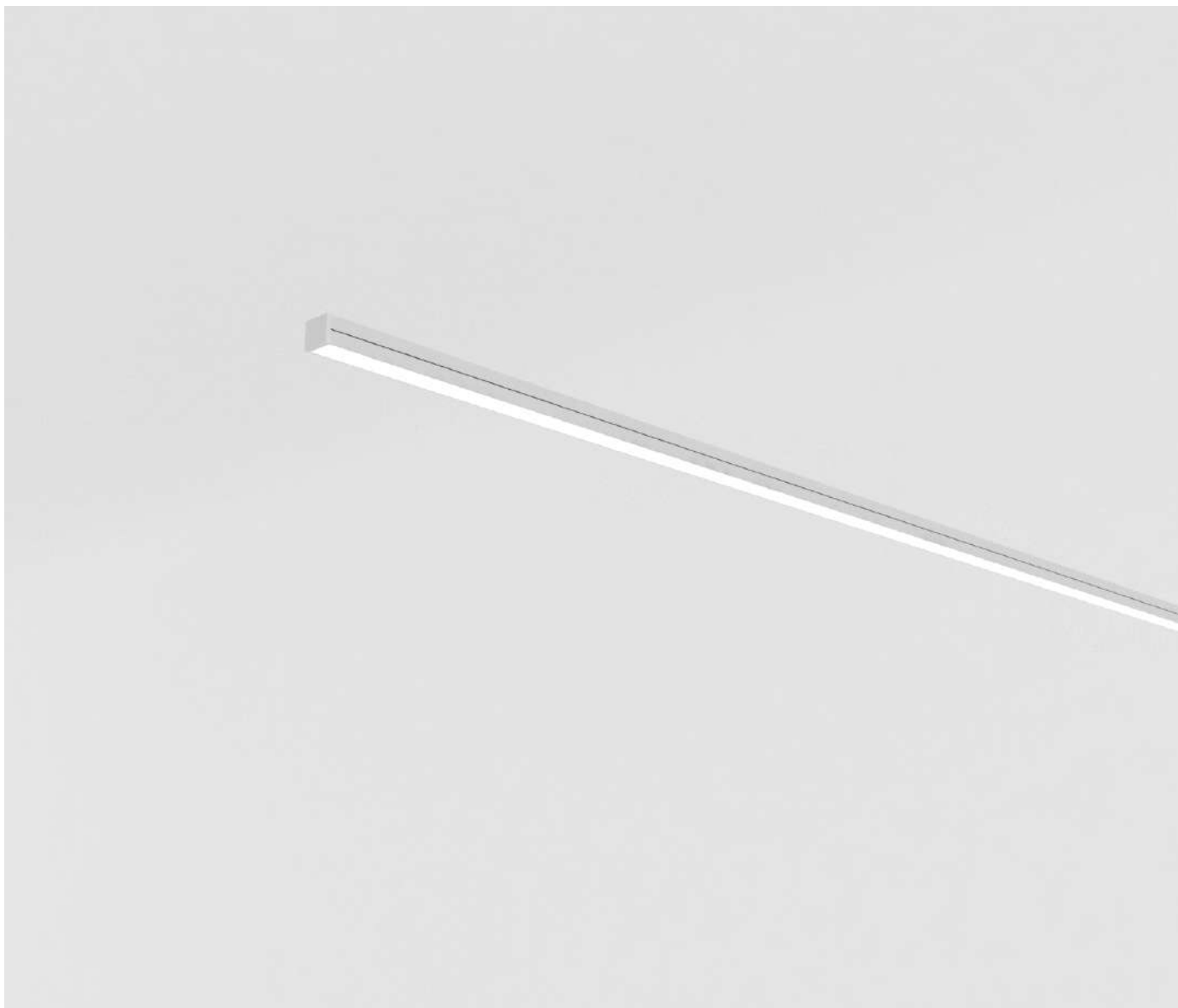

Product	
Code	PLD 100
Name	TOBY
Categories	PROFIL
Subcategory	Linear
	Decorative
Type	Pendant
	Ceiling lamp
Length	< 5 M
Finishing	RAL on request

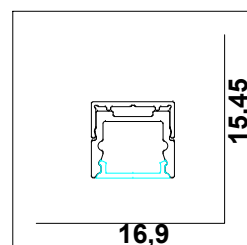

Product Specifications		General Information		Lamp Specifications	
Product Code	PLD 100	Suspension System	2 wire set	Lamp Type	LED
Body	Extruded Aluminum	Protection	IP40	LED Chip	Samsung
Number of light source	1	Installation	Indoor	Luminous Flux	110 lm/W
Light source color	2700 K → 6000 K	Mounting	Surface mounted / Pendant	Power	4 W–20 W/m
Cap-Base	N/A	Trimless	N/A	Colour Temperature	2700 K → 6000 K
Light source replacable	Yes	Warranty Period	2 years	Length	2.5 cm → 50 cm
Luminaire light beam	120°			Width	0.8 cm

PLD 100

TOBY



Physical Specifications		Physical Specifications		Options	
Structure	Extruded Aluminum	Finishing	Aluminum anodized/RAL	Length	On request
Reflector	N/A	Weight	-	Finish	RAL on request
Optical Cover	PC Opal	Body	Extruded Aluminum	Dimmable	On request
Fixation material	Aluminum/Stainless Steel	Diffuser	PC Opal	Trimless	N/A
Length	On request	UV Protection	Yes	Colour Temperature	2700K → 6000K
Width	16.9 mm			IP Rate	IP44
Height	15.45 mm				

Electrical Specifications		Performance		Remarks	
Input Voltage	220-240V	Power	4W-15W/m	Customized length	
Input Frequency	50-60 hz	Luminous Flux	400 lm-1500 lm/m	Angular shapes	
Dimmable	On request	Luminous flux tolerance	10%	RGB version	
Output	24V	Colour Temperature	2700 K → 6000 K		
IP Rate	IP20-IP67	Colour Rendering Index	≥80		
Power Factor	-	LED Luminaire Efficacy	100 lm/W		
Power	-				

PLD 080

ELY

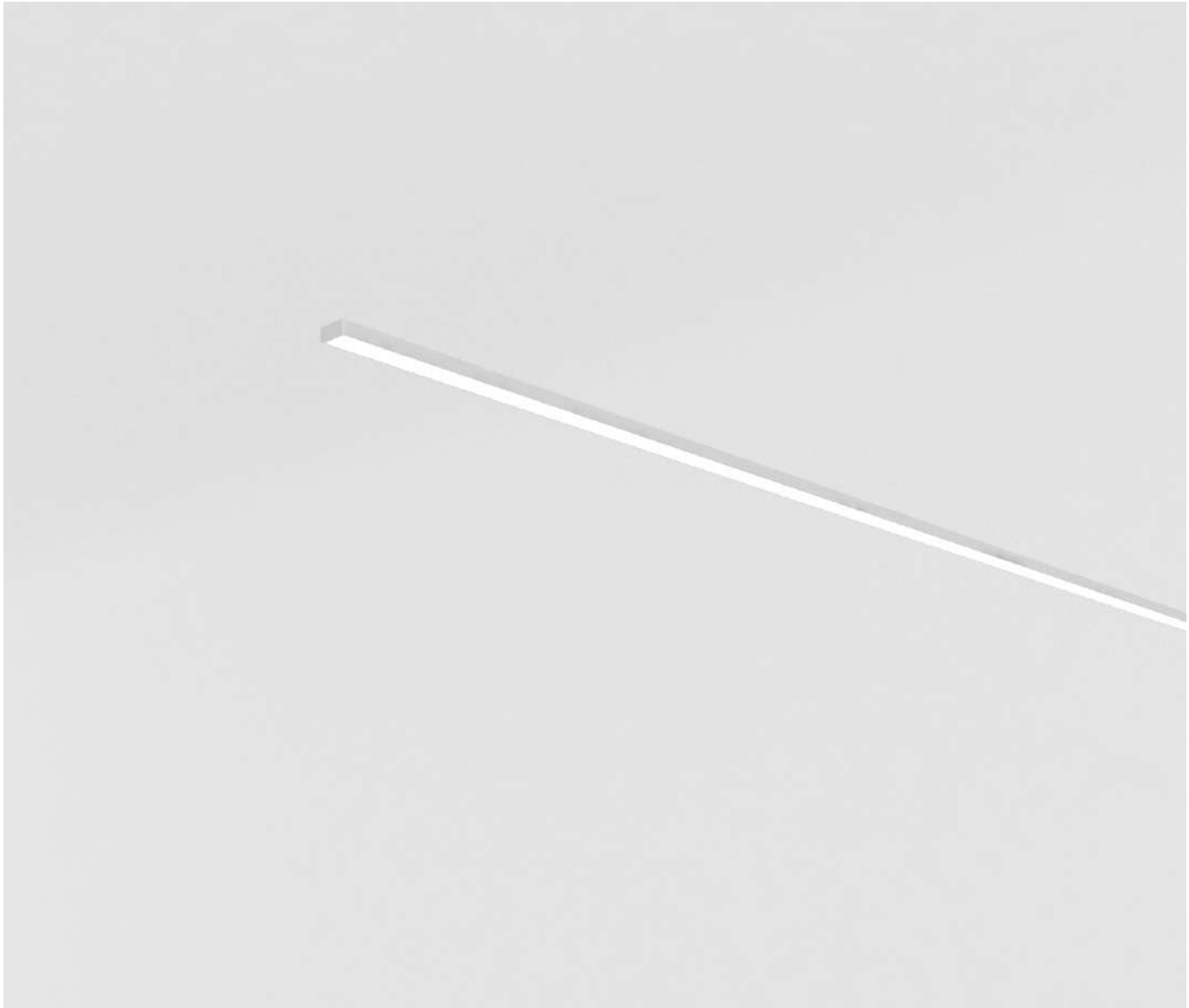

Product	
Code	PLD 080
Name	ELY
Categories	PROFIL
Subcategory	Linear
	Decorative
Type	Ceiling lamp
Length	< 5 M
Finishing	RAL on request

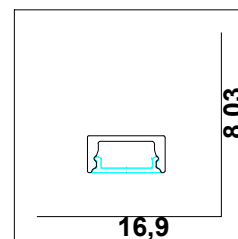

Product Specifications		General Information		Lamp Specifications	
Product Code	PLD 080	Suspension System	N/A	Lamp Type	LED
Body	Extruded Aluminum	Protection	IP40	LED Chip	Samsung
Number of light source	1	Installation	Indoor	Luminous Flux	110 lm/W
Light source color	2700 K → 6000 K	Mounting	Surface mounted	Power	4 W–20 W/m
Cap-Base	N/A	Trimless	N/A	Colour Temperature	2700 K → 6000 K
Light source replacable	Yes	Warranty Period	2 years	Length	2.5 cm → 50 cm
Luminaire light beam	120°			Width	0.8 cm

PLD 080

ELY

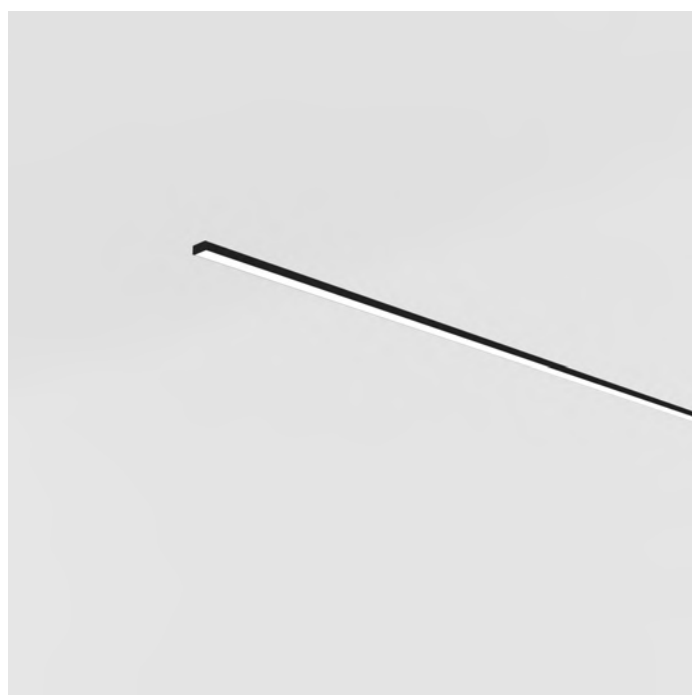
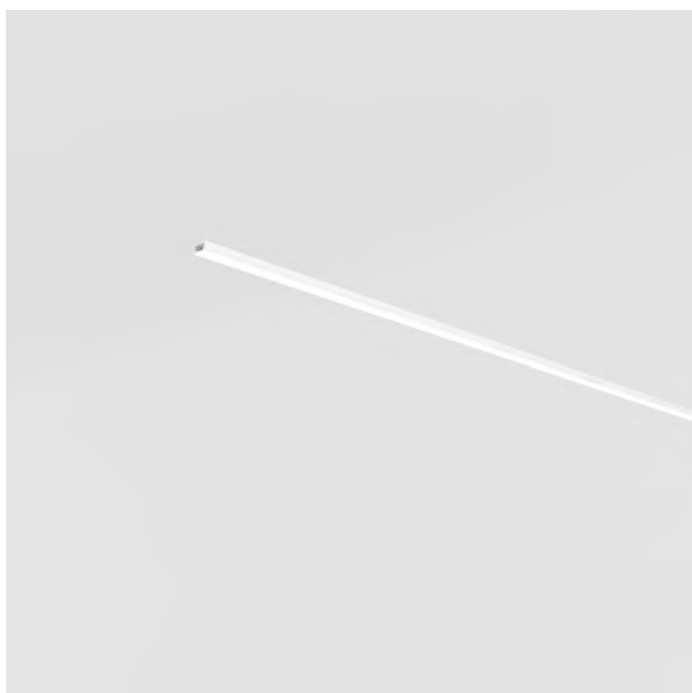

Physical Specifications		Physical Specifications		Options	
Structure	Extruded Aluminum	Finishing	Aluminum anodized/RAL	Length	On request
Reflector	N/A	Weight	-	Finish	RAL on request
Optical Cover	PC Opal	Body	Extruded Aluminum	Dimmable	On request
Fixation material	Aluminum/Stainless Steel	Diffuser	PC Opal	Trimless	N/A
Length	On request	UV Protection	Yes	Colour Temperature	2700K -> 6000K
Width	16.9 mm			IP Rate	IP44
Height	8 mm				

Electrical Specifications		Performance		Remarks	
Input Voltage	220-240V	Power	4W-15W/m	Customized length	
Input Frequency	50-60 hz	Luminous Flux	400 lm-1500 lm/m	Angular shapes	
Dimmable	On request	Luminous flux tolerance	10%	RGB version	
Output	24V	Colour Temperature	2700 K -> 6000 K		
IP Rate	IP20-IP67	Colour Rendering Index	≥80		
Power Factor	-	LED Luminaire Efficacy	100 lm/W		
Power	-				

PLD 005

BRAT



Product	
Code	PLD 005
Name	BRAT
Categories	PROFIL
Subcategory	Linear
	Decorative
Type	Pendant
	Ceiling lamp
Lenght	< 5 M
Finishing	RAL on request

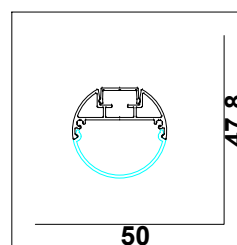

Product Specifications		General Information		Lamp Specifications	
Product Code	PLD 005	Suspension System	2 wire set	Lamp Type	LED
Body	Extruded Aluminum	Protection	IP40	LED Chip	Samsung
Number of light source	2	Installation	Indoor	Luminous Flux	110 lm/W
Light source color	2700 K → 6000 K	Mounting	Surface mounted/ Pendant	Power	4 W-20 W/m
Cap-Base	22cm	Trimless	N/A	Colour Temperature	2700 K → 6000 K
Light source replacable	Yes	Warranty Period	2 years	Length	2.5 cm → 50 cm
Luminaire light beam	120°			Width	0.8 cm

PLD 005

BRAT

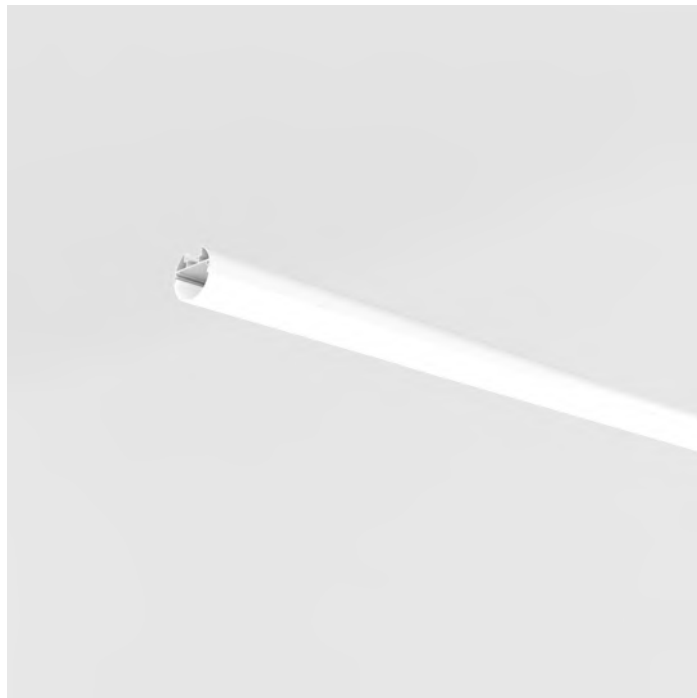

Physical Specifications		Physical Specifications		Options	
Structure	Extruded Aluminum	Finishing	Aluminum anodized/RAL	Length	On request
Reflector	N/A	Weight	-	Finish	RAL on request
Optical Cover	PC Opal	Body	Extruded Aluminum	Dimmable	On request
Fixation material	Aluminum/Stainless Steel	Diffuser	PC Opal	Trimless	N/A
Length	On request	UV Protection	Yes	Colour Temperature	2700K → 6000K
Width	50 mm			IP Rate	IP44
Height	47.8 mm				

Electrical Specifications		Performance		Remarks
Input Voltage	220-240V	Power	8W-40W/m	Customized length
Input Frequency	50-60 hz	Luminous Flux	800 lm-4000 lm/m	Angular shapes
Dimmable	On request	Luminous flux tolerance	10%	RGB version
Output	24V	Colour Temperature	2700 K → 6000 K	
IP Rate	IP20-IP67	Colour Rendering Index	≥80	
Power Factor	-	LED Luminaire Efficacy	100 lm/W	
Power	-			

PLD 006

CYLINDER

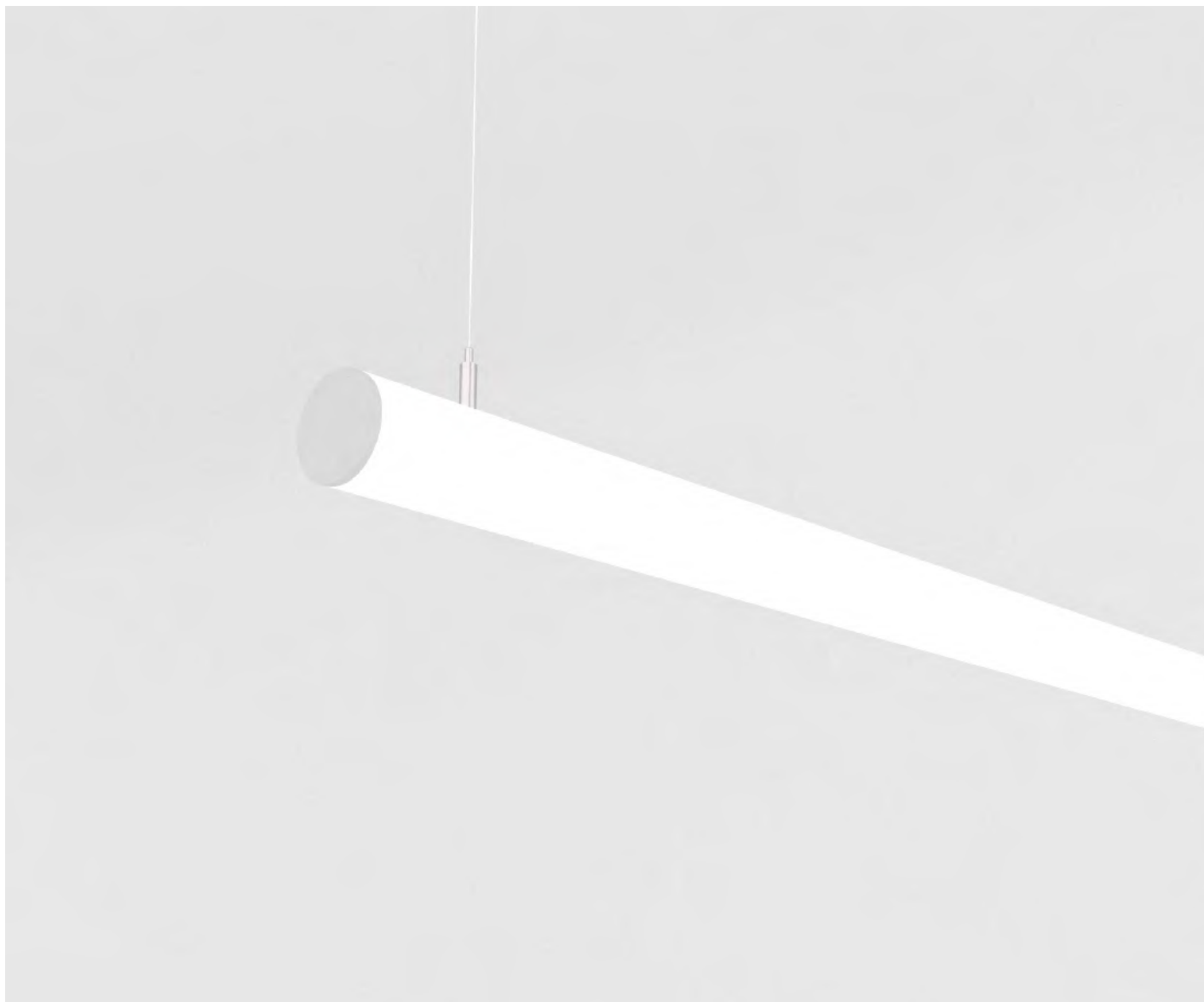

Product	
Code	PLD 006
Name	CYLINDER
Categories	PROFIL
Subcategory	Linear
Type	Decorative Pendant
	Ceilig lamp
Length	< 5 M
Finishing	RAL on request

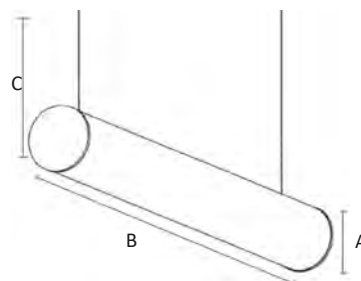

Product Specifications		General Information		Lamp Specifications	
Product Code	PLD 006	Suspension System	N/A	Lamp Type	LED
Body	Extruded Aluminum	Protection	IP40	LED Chip	Samsung
Number of light source	8	Installation	Indoor	Luminous Flux	110 lm/W
Light source color	2700 K → 6000 K	Mounting	Surface mounted/ Pendant	Power	4 W–20 W/m
Cap-Base	22cm	Trimless	N/A	Colour Temperature	2700 K → 6000 K
Light source replacable	Yes	Warranty Period	2 years	Length	2,5 cm → 50 cm
Luminaire light beam	120°			Width	0.8 cm

PLD 006

CYLINDER

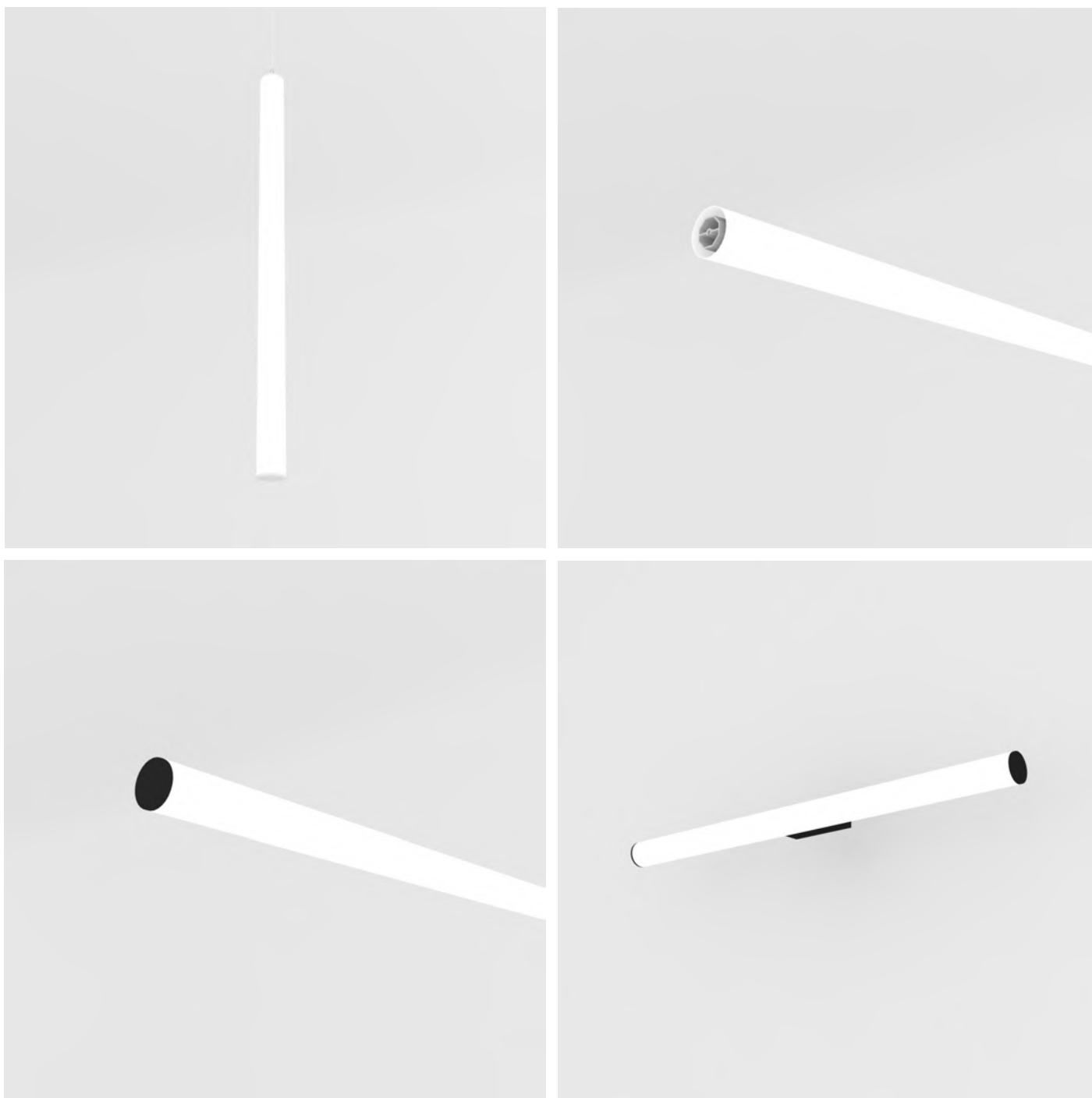

Physical Specifications		Physical Specifications		Options	
Structure	Extruded Aluminum	Finishing	Aluminum anodized/RAL	Length	On request
Reflector	N/A	Weight	-	Finish	RAL on request
Optical Cover	PC Opal	Body	Extruded Aluminum	Dimmable	On request
Fixation material	Aluminum/Stainless Steel	Diffuser	PC Opal	Trimless	N/A
A	60mm	UV Protection	Yes	Colour Temperature	2700K -> 6000K
B	On Request			IP Rate	IP44
C	1500mm				

Electrical Specifications		Performance		Remarks
Input Voltage	220-240V	Power	40W	Customized length
Input Frequency	50-60 hz	Luminous Flux	4000 lm/m	Angular shapes
Dimmable	On request	Luminous flux tolerance	10%	RGB version
Output	24V	Colour Temperature	2700 K -> 6000 K	
IP Rate	IP20-IP67	Colour Rendering Index	≥80	
Power Factor	-	LED Luminaire Efficacy	100 lm/W	
Power	-			

PLD 007

ALT

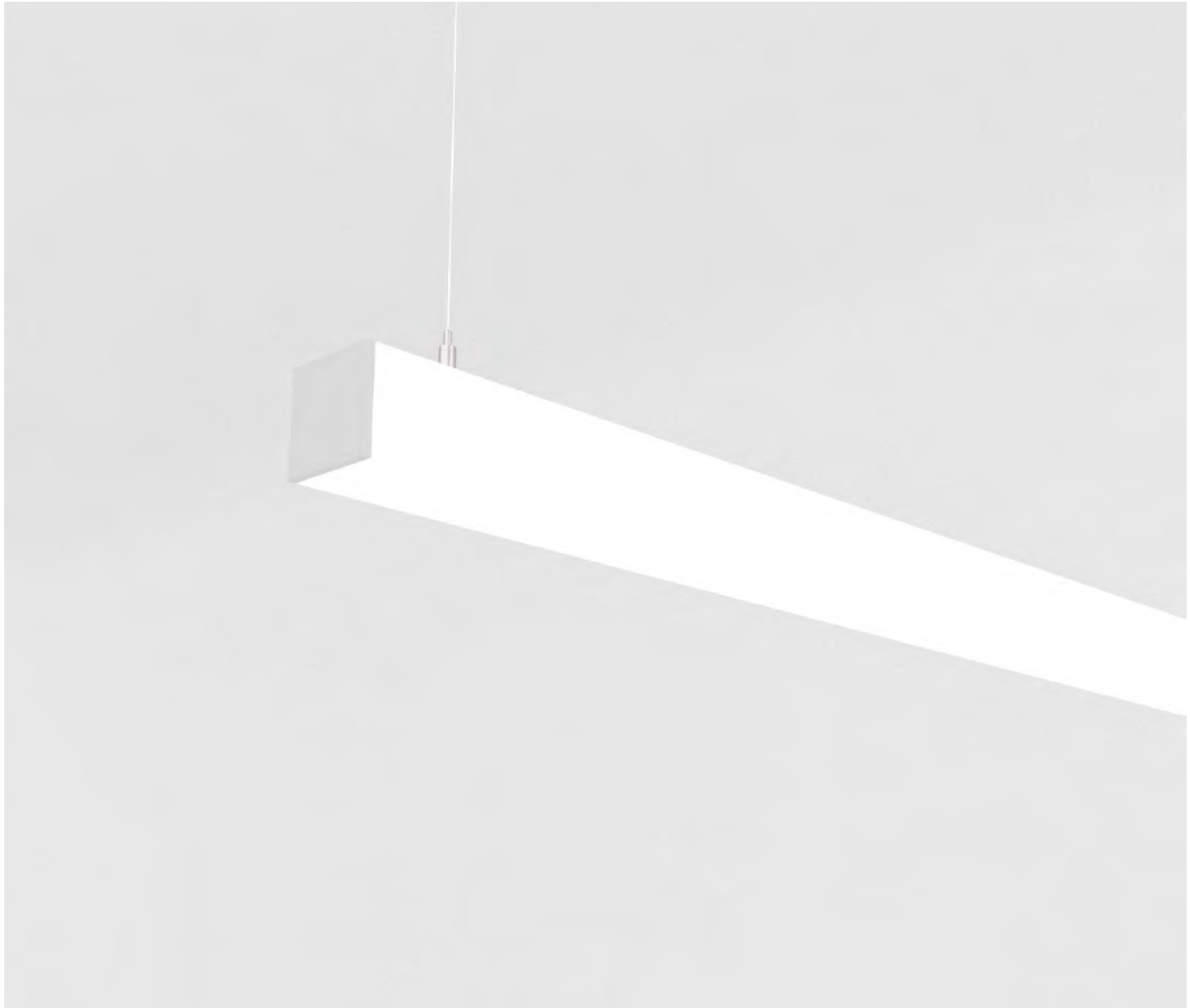
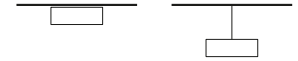

Product	
Code	PLD 007
Name	ALT
Categories	PROFIL
Subcategory	Linear
Type	Decorative Pendant
	Ceiling lamp
Lenght	< 5 M
Finishing	RAL on request

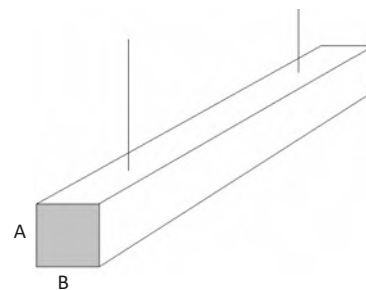

Product Specifications		General Information		Lamp Specifications	
Product Code	PLD 007	Suspension System	2 wire set	Lamp Type	LED
Body	Extruded Aluminum	Protection	IP40	LED Chip	Samsung
Number of light source	8	Installation	Indoor	Luminous Flux	110 lm/W
Light source color	2700 K -> 6000 K	Mounting	Surface mounted/ Pendant	Power	4 W-20 W/m
Cap-Base	22cm	Trimless	N/A	Colour Temperature	2700 K -> 6000 K
Light source replacable	Yes	Warranty Period	2 years	Length	2.5 cm -> 50 cm
Luminaire light beam	120°			Width	0.8 cm

PLD 007

ALT

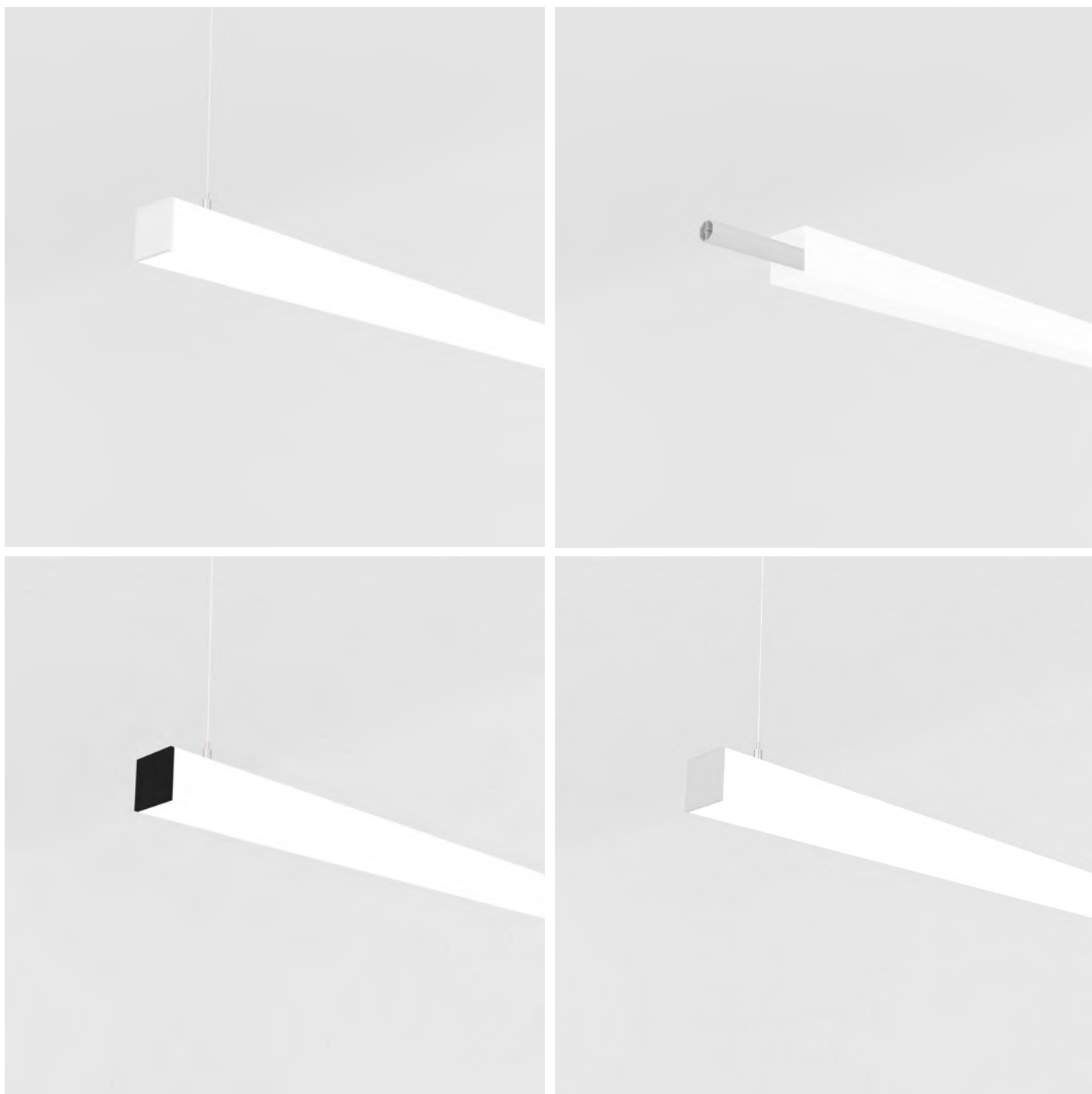

Physical Specifications		Physical Specifications		Options	
Structure	Extruded Aluminum	Finishing	Aluminum anodized/RAL	Length	On request
Reflector	N/A	Weight	–	Finish	RAL on request
Optical Cover	PC Opal	Body	Extruded Aluminum	Dimmable	On request
Fixation material	Aluminum/Stainless Steel	Diffuser	PC Opal	Trimless	N/A
A	60 mm	UV Protection	Yes	Colour Temperature	2700K -> 6000K
B	60 mm			IP Rate	IP44

Electrical Specifications		Performance		Remarks	
Input Voltage	220–240V	Power	40W	Customized length	
Input Frequency	50–60 hz	Luminous Flux	4000 lm/m	Angular shapes	
Dimmable	On request	Luminous flux tolerance	10%	RGB version	
Output	24V	Colour Temperature	2700 K -> 6000 K		
IP Rate	IP20-IP67	Colour Rendering Index	≥80		
Power Factor	–	LED Luminaire Efficacy	100 lm/W		
Power	–				

PLD 008

CYLINDER B

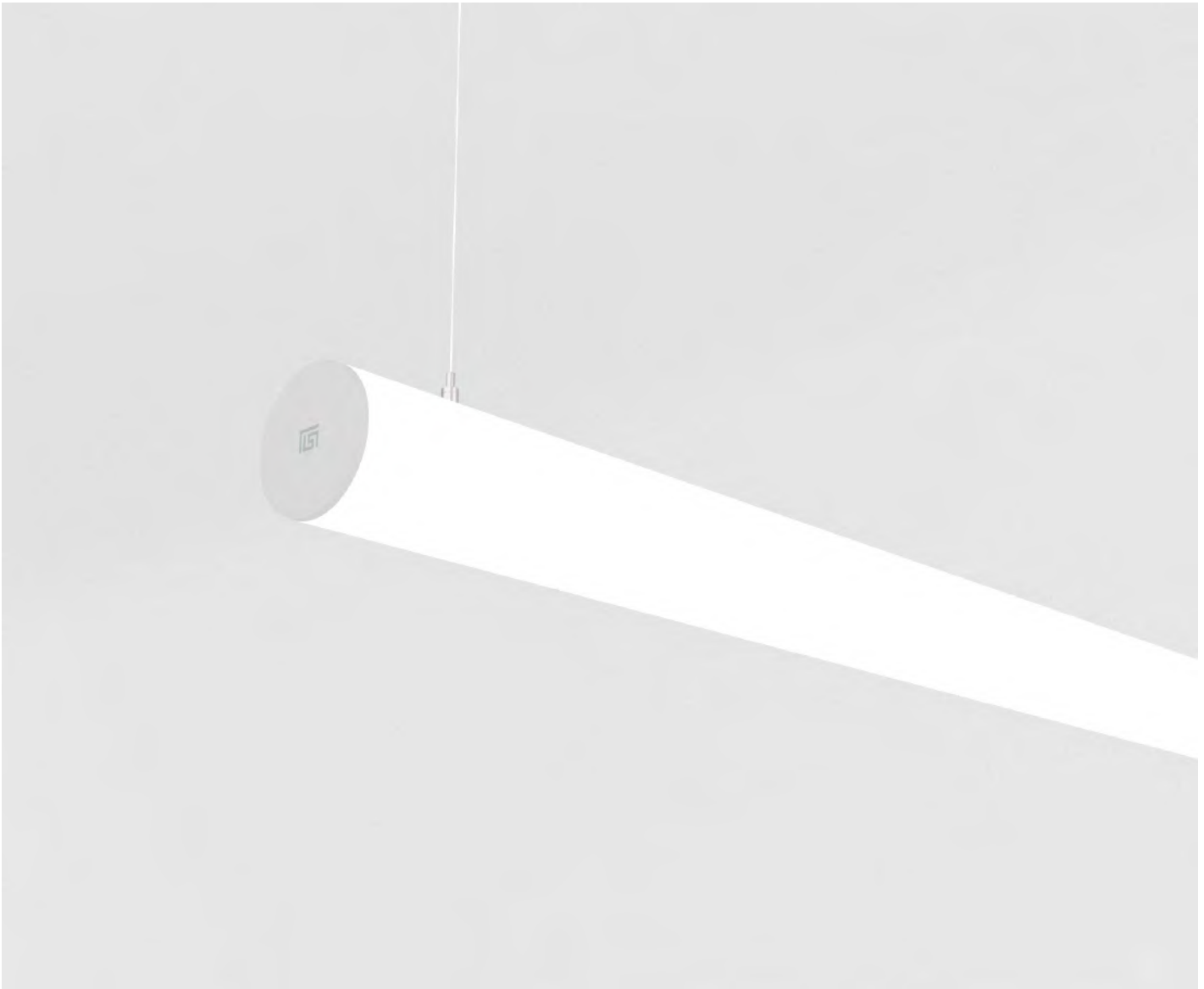

Product	
Code	PLD 008
Name	CYLINDER B
Categories	PROFIL
Subcategory	Linear
Type	Decorative Pendant
	Ceilig lamp
Length	< 5 M
Finishing	RAL on request

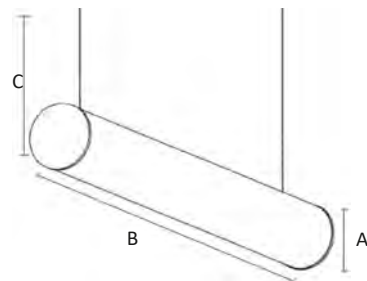

Product Specifications		General Information		Lamp Specifications	
Product Code	PLD 008	Suspension System	N/A	Lamp Type	LED
Body	Extruded Aluminum	Protection	IP40	LED Chip	Samsung
Number of light source	8	Installation	Indoor	Luminous Flux	110 lm/W
Light source color	2700 K → 6000 K	Mounting	Surface mounted/ Pendant	Power	4 W-20 W/m
Cap-Base	22cm	Trimless	N/A	Colour Temperature	2700 K → 6000 K
Light source replacable	Yes	Warranty Period	2 years	Length	2,5 cm → 50 cm
Luminaire light beam	120°			Width	0.8 cm

PLD 008

CYLINDER B

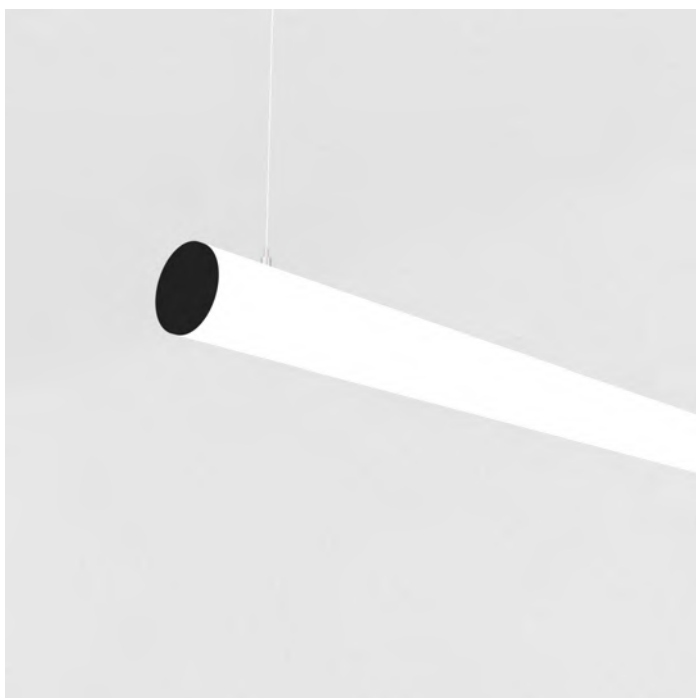
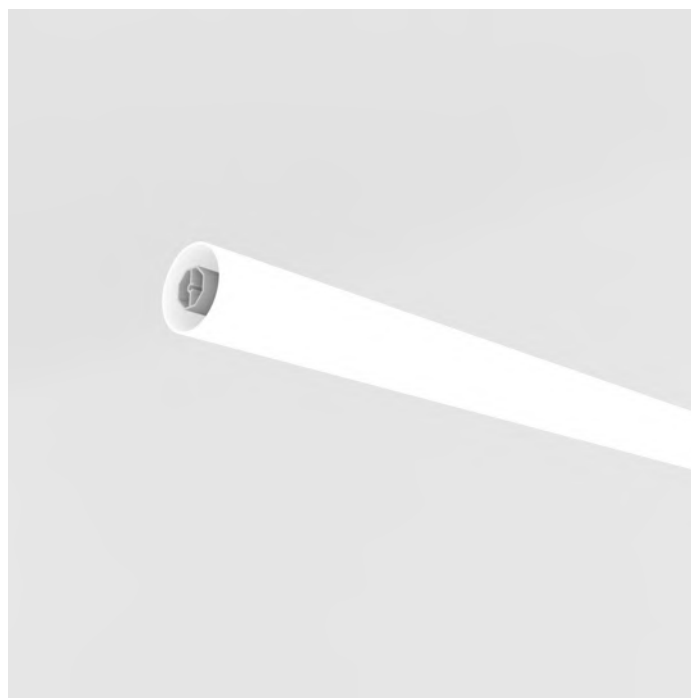

Physical Specifications		Physical Specifications		Options	
Structure	Extruded Aluminum	Finishing	Aluminum anodized/RAL	Length	On request
Reflector	N/A	Weight	-	Finish	RAL on request
Optical Cover	PC Opal	Body	Extruded Aluminum	Dimmable	On request
Fixation material	Aluminum/Stainless Steel	Diffuser	PC Opal	Trimless	N/A
A	80mm	UV Protection	Yes	Colour Temperature	2700K -> 6000K
B	On Request			IP Rate	IP44
C	1500mm				

Electrical Specifications		Performance		Remarks	
Input Voltage	220-240V	Power	40W	Customized length	
Input Frequency	50-60 hz	Luminous Flux	4000 lm/m	Angular shapes	
Dimmable	On request	Luminous flux tolerance	10%	RGB version	
Output	24V	Colour Temperature	2700 K -> 6000 K		
IP Rate	IP20-IP67	Colour Rendering Index	≥80		
Power Factor	-	LED Luminaire Efficacy	100 lm/W		
Power	-				

PLD 009

ATYPIC

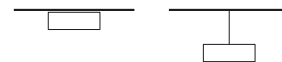

Product	
Code	PLD 009
Name	ATYPIC
Categories	PROFIL
Subcategory	Linear
	Decorative
Type	Pendant
	Ceiling lamp
Length	< 5 M
Finishing	RAL on request



Product Specifications		General Information		Lamp Specifications	
Product Code	PLD 009	Suspension System	N/A	Lamp Type	LED
Body	Extruded Aluminum	Protection	IP40	LED Chip	Samsung
Number of light source	8	Installation	Indoor	Luminous Flux	110 lm/W
Light source color	2700 K -> 6000 K	Mounting	Surface mounted/ Pendant	Power	4 W-20 W/m
Cap-Base	22cm	Trimless	N/A	Colour Temperature	2700 K -> 6000 K
Light source replacable	Yes	Warranty Period	2 years	Length	2.5 cm -> 50 cm
Luminaire light beam	120°			Width	0.8 cm

PLD 009

ATYPIC

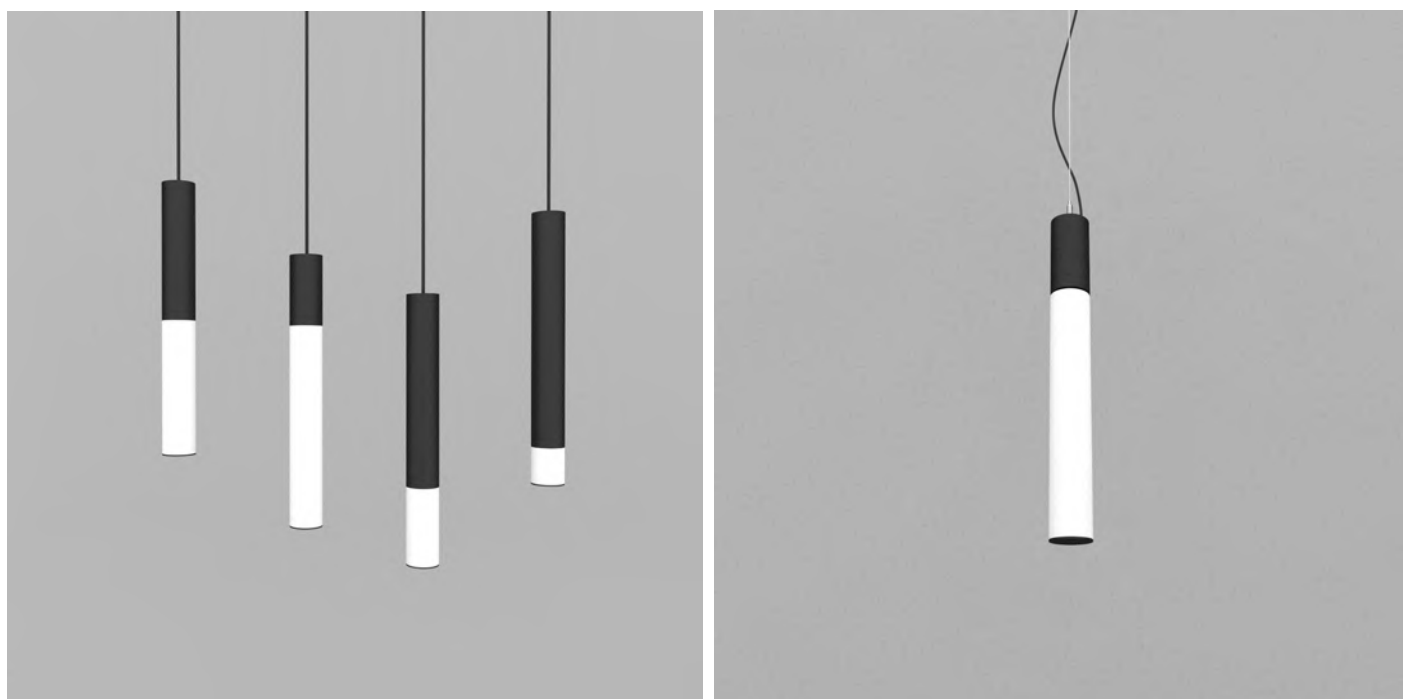
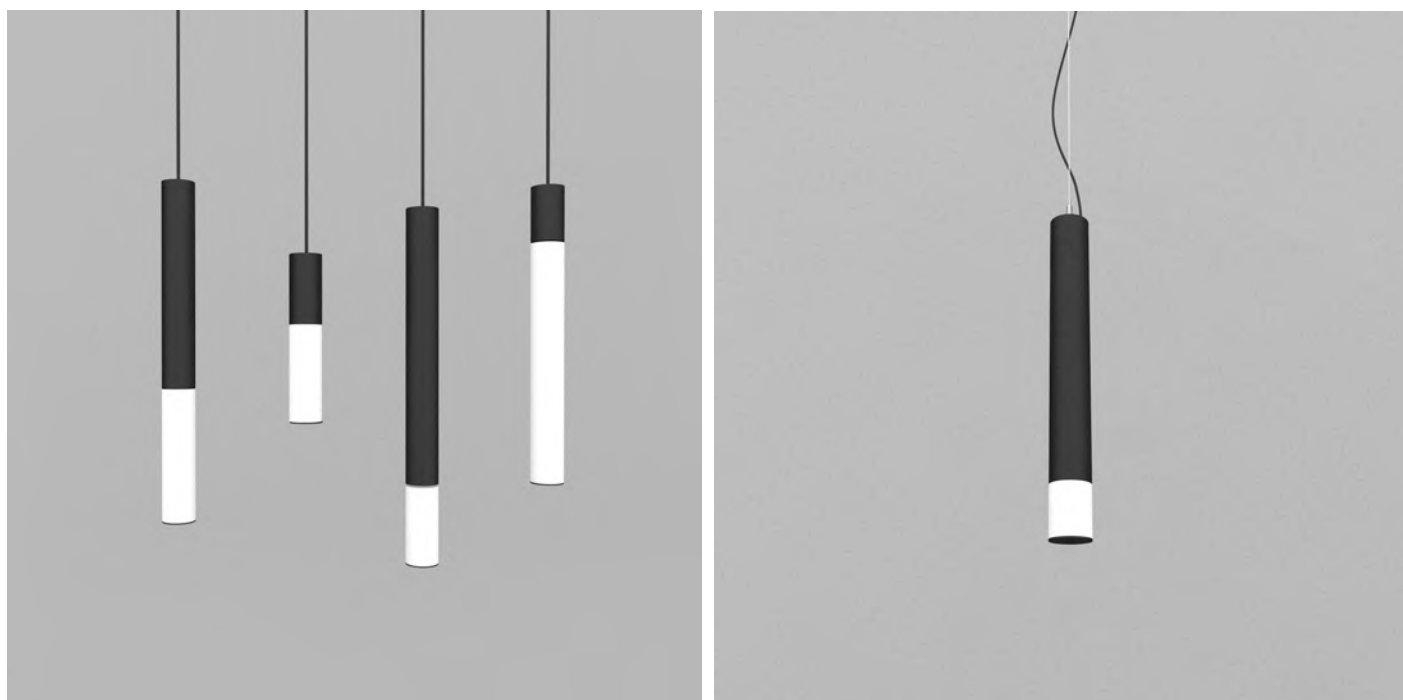
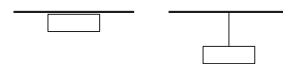

Physical Specifications		Physical Specifications		Options	
Structure	Extruded Aluminum	Finishing	Aluminum anodized/RAL	Height	On request
Reflector	N/A	Weight	-	Finish	RAL on request
Optical Cover	PC Opal	Body	Extruded Aluminum	Dimmable	On request
Fixation material	Aluminum/Stainless Steel	Diffuser	PC Opal	Trimless	N/A
A	60mm	UV Protection	Yes	Colour Temperature	2700K → 6000K
B	1500mm			IP Rate	IP44

Electrical Specifications		Performance		Remarks	
Input Voltage	220-240V	Power	3W - 40W/m	Customized length	
Input Frequency	50-60 hz	Luminous Flux	4000 lm/m	Angular shapes	
Dimmable	On request	Luminous flux tolerance	10%	RGB version	
Output	24V	Colour Temperature	2700 K → 6000 K		
IP Rate	IP20-IP67	Colour Rendering Index	≥80		
Power Factor	-	LED Luminaire Efficacy	100 lm/W		
Power	-				

PLD 010

DYNAMIC

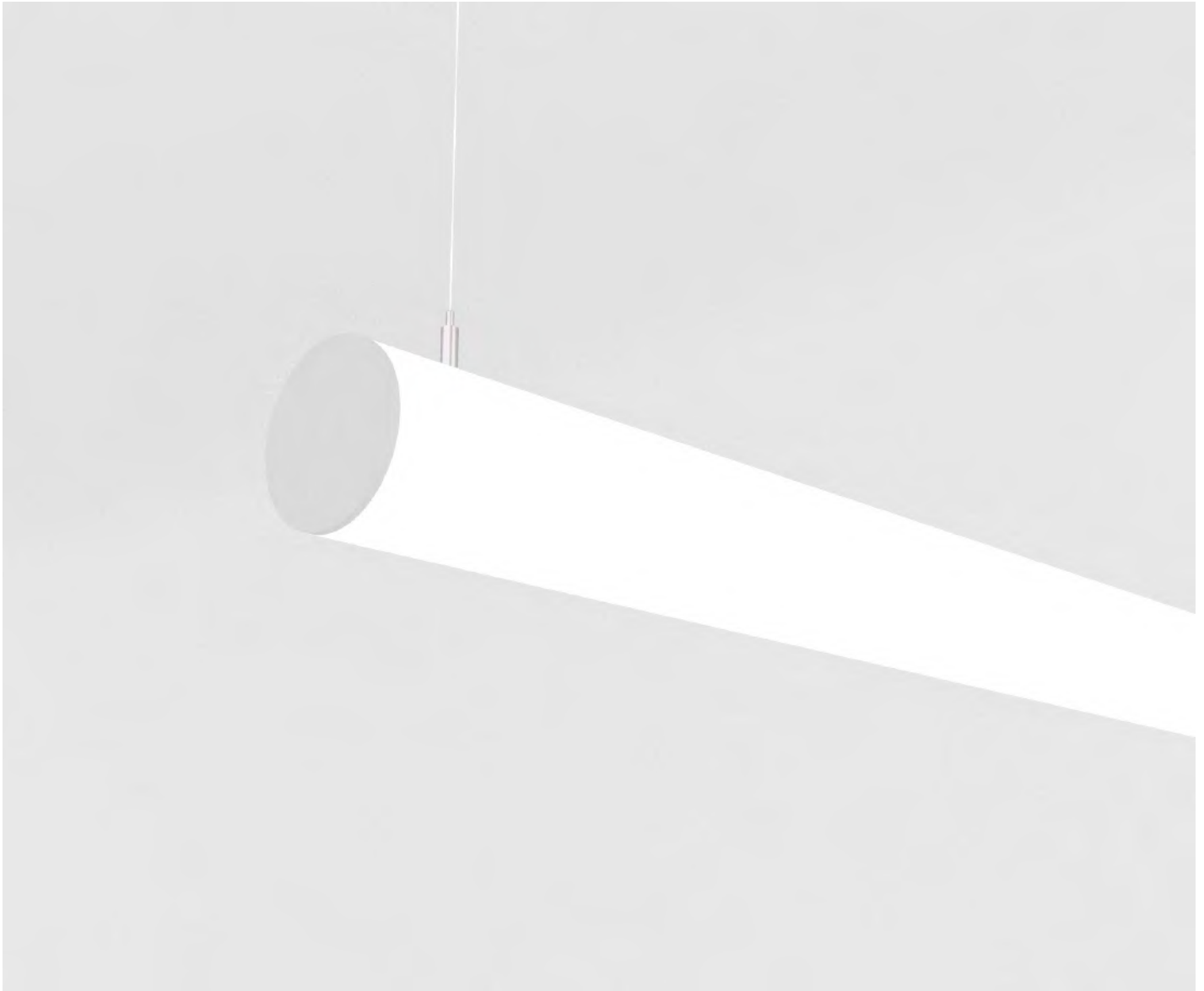
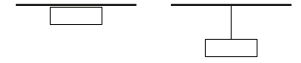

Product	
Code	PLD 010
Name	DYNAMIC
Categories	PROFIL
Subcategory	Linear
	Decorative
Type	Pendant
	Ceiling lamp
Length	< 5 M
Finishing	RAL on request

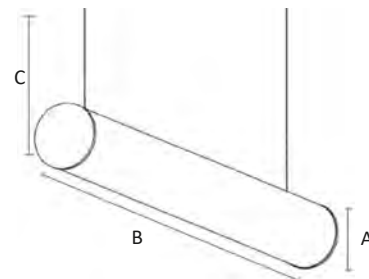

Product Specifications		General Information		Lamp Specifications	
Product Code	PLD 010	Suspension System	N/A	Lamp Type	LED
Body	Extruded Aluminum	Protection	IP40	LED Chip	Samsung
Number of light source	3	Installation	Indoor	Luminous Flux	110 lm/W
Light source color	2700 K → 6000 K	Mounting	Surface mounted/ Pendant	Power	4 W–20 W/m
Cap-Base	22cm	Trimless	N/A	Colour Temperature	2700 K → 6000 K
Light source replacable	Yes	Warranty Period	2 years	Length	2.5 cm → 50 cm
Luminaire light beam	120°			Width	0.8 cm

PLD 010

DYNAMIC

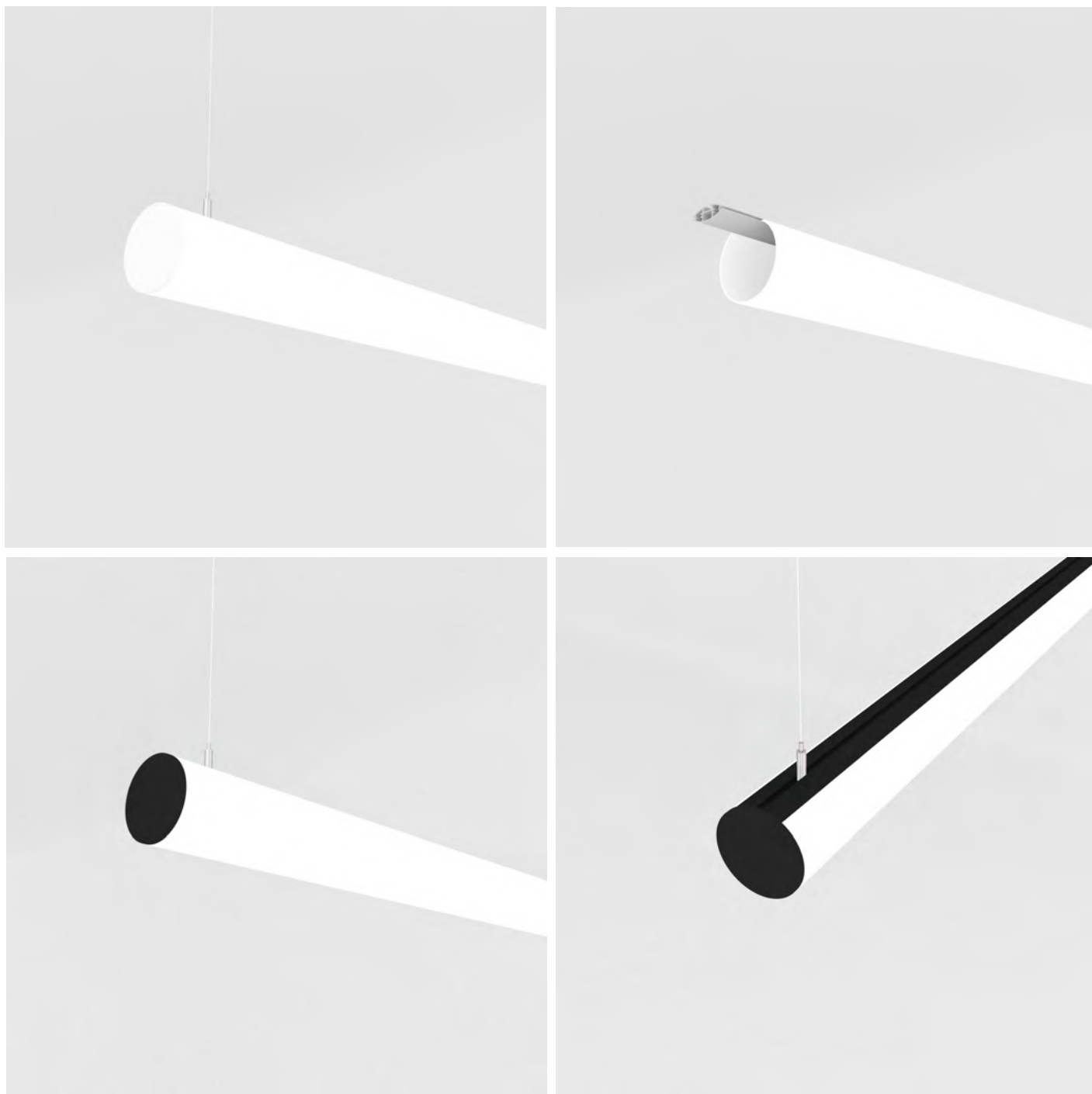

Physical Specifications		Physical Specifications		Options	
Structure	Extruded Aluminum	Finishing	Aluminum anodized/RAL	Length	On request
Reflector	N/A	Weight	–	Finish	RAL on request
Optical Cover	PC Opal	Body	Extruded Aluminum	Dimmable	On request
Fixation material	Aluminum/Stainless Steel	Diffuser	PC Opal	Trimless	N/A
A	100mm	UV Protection	Yes	Colour Temperature	2700K → 6000K
B	On request			IP Rate	IP44
C	1500 mm				

Electrical Specifications		Performance		Remarks
Input Voltage	220–240V	Power	12W - 60W/m	Customized length
Input Frequency	50–60 hz	Luminous Flux	1200lm - 6000 lm/m	Angular shapes
Dimmable	On request	Luminous flux tolerance	10%	RGB version
Output	24V	Colour Temperature	2700 K → 6000 K	
IP Rate	IP20-IP67	Colour Rendering Index	≥80	
Power Factor	–	LED Luminaire Efficacy	100 lm/W	
Power	–			

PLD 4000

OPTIM

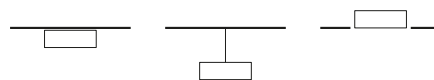

Product	
Code	PLD 4000
Name	OPTIM
Categories	PROFIL
Subcategory	Linear
	Decorative
Type	Pendant
	Ceiling lamp
	Trimless
Length	< 5 M
Finishing	RAL on request

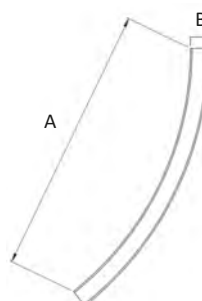

Product Specifications		General Information		Lamp Specifications	
Product Code	PLD 4000	Suspension System	2 wire set	Lamp Type	LED
Body	Extruded Aluminum	Protection	IP40	LED Chip	Samsung
Number of light source	1	Installation	Indoor	Luminous Flux	110 lm/W
Light source color	2700 K -> 6000 K	Mounting	Surface mounted/ Pendant	Power	4 W-20 W/m
Cap-Base	22 cm	Trimless	On request	Colour Temperature	2700 K -> 6000 K
Light source replacable	Yes	Warranty Period	2 years	Length	2.5 cm -> 50 cm
Luminaire light beam	120°			Width	0.8 cm

PLD 4000

OPTIM

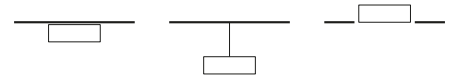

Physical Specifications		Physical Specifications		Options	
Structure	Extruded Aluminum	Finishing	Aluminum anodized/RAL	Length	On request
Reflector	N/A	Weight	–	Finish	RAL on request
Optical Cover	Plexiglass	Body	Extruded Aluminum	Dimmable	On request
Fixation material	Aluminum/Stainless Steel	Diffuser	Plexiglass	Trimless	On request
A	On request	UV Protection	Yes	Colour Temperature	2700K → 6000K
B	41 mm			IP Rate	IP44

Electrical Specifications		Performance		Remarks	
Input Voltage	220–240V	Power	4W–20W/m	Customized length	
Input Frequency	50–60 hz	Luminous Flux	400 lm–2000 lm/m	Angular shapes	
Dimmable	On request	Luminous flux tolerance	10%	RGB version	
Output	24V	Colour Temperature	2700 K → 6000 K		
IP Rate	IP20-IP67	Colour Rendering Index	≥80		
Power Factor	–	LED Luminaire Efficacy	100 lm/W		
Power	–				

PLD 4050

RINGA

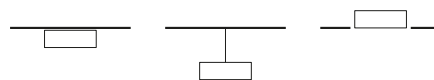

Product	
Code	PLD 4050
Name	RINGA
Categories	PROFIL
Subcategory	Linear
	Decorative
Type	Pendant
	Ceiling lamp
	Trimless
Length	< 5 M
Finishing	RAL on request

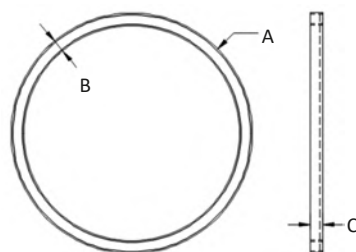

Product Specifications		General Information		Lamp Specifications	
Product Code	PLD 4050	Suspension System	3 wire set	Lamp Type	LED
Body	Extruded Aluminum	Protection	IP40	LED Chip	Samsung
Number of light source	1	Installation	Indoor	Luminous Flux	110 lm/W
Light source color	2700 K → 6000 K	Mounting	Surface mounted/ Pendant	Power	4 W-20 W/m
Cap-Base	22 cm	Trimless	On request	Colour Temperature	2700 K → 6000 K
Light source replacable	Yes	Warranty Period	2 years	Length	2.5 cm → 50 cm
Luminaire light beam	120°			Width	0.8 cm

PLD 4050

RINGA

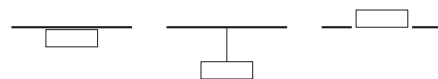

Physical Specifications		Physical Specifications		Options	
Structure	Extruded Aluminum	Finishing	Aluminum anodized/RAL	Diameter	On request
Reflector	N/A	Weight	-	Finish	RAL on request
Optical Cover	Plexiglass	Body	Extruded Aluminum	Dimmable	On request
Fixation material	Aluminum/Stainless Steel	Diffuser	Plexiglass	Trimless	On request
A	55cm - 85cm	UV Protection	Yes	Colour Temperature	2700K -> 6000K
B	4.1cm			IP Rate	IP44
C	4.1cm				

Electrical Specifications		Performance		Remarks	
Input Voltage	220-240V	Power	32W - 50W	Customized length	
Input Frequency	50-60 hz	Luminous Flux	3200 lm - 5000 lm	Angular shapes	
Dimmable	On request	Luminous flux tolerance	10%	RGB version	
Output	24V	Colour Temperature	2700 K -> 6000 K		
IP Rate	IP20-IP67	Colour Rendering Index	≥80		
Power Factor	-	LED Luminaire Efficacy	100 lm/W		
Power	-				

PLD 5000

CIRCLE ONE

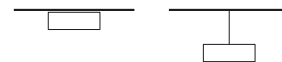

Product	
Code	PLD 5000
Name	CIRCLE ONE
Categories	PROFIL
Subcategory	Linear
	Decorative
Type	Pendant
	Ceiling lamp
Length	< 5 M
Finishing	RAL on request

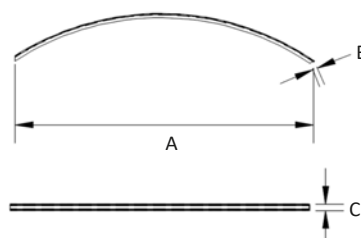

Product Specifications		General Information		Lamp Specifications	
Product Code	PLD 5000	Suspension System	2 wire set	Lamp Type	LED
Body	Extruded Aluminum	Protection	IP40	LED Chip	Samsung
Number of light source	1	Installation	Indoor	Luminous Flux	110 lm/W
Light source color	2700 K → 6000 K	Mounting	Surface mounted/ Pendant	Power	4 W-20 W/m
Cap-Base	22cm	Trimless	N/A	Colour Temperature	2700 K → 6000 K
Light source replacable	Yes	Warranty Period	2 years	Length	2.5 cm → 50 cm
Luminaire light beam	120°			Width	0.8 cm

PLD 5000

CIRCLE ONE



Physical Specifications		Physical Specifications		Options	
Structure	Extruded Aluminum	Finishing	Aluminum anodized/RAL	Length	On request
Reflector	N/A	Weight	-	Finish	RAL on request
Optical Cover	PC Opal	Body	Extruded Aluminum	Dimmable	On request
Fixation material	Aluminum/Stainless Steel	Diffuser	PC Opal	Trimless	N/A
A	On request	UV Protection	Yes	Colour Temperature	2700K -> 6000K
B	25 mm			IP Rate	IP44
C	20 mm				
Electrical Specifications		Performance		Remarks	
Input Voltage	220-240V	Power	4W - 20W/m	Customized length	
Input Frequency	50-60 hz	Luminous Flux	400lm - 2000 lm/m	Angular shapes	
Dimmable	On request	Luminous flux tolerance	10%	RGB version	
Output	24V	Colour Temperature	2700 K -> 6000 K		
IP Rate	IP20-IP67	Colour Rendering Index	≥80		
Power Factor	-	LED Luminaire Efficacy	100 lm/W		
Power	-				

PLD 5010

WALTZ



Product	
Code	PLD 5010
Name	WALTZ
Categories	PROFIL
Subcategory	Linear
	Decorative
Type	Pendant
	Ceiling lamp
Length	< 5 M
Finishing	RAL on request

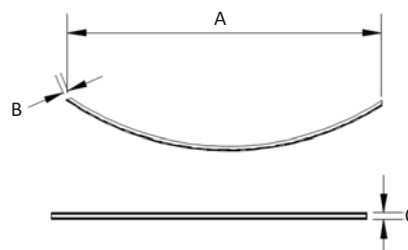

Product Specifications		General Information		Lamp Specifications	
Product Code	PLD 5010	Suspension System	2 wire set	Lamp Type	LED
Body	Extruded Aluminum	Protection	IP40	LED Chip	Samsung
Number of light source	1	Installation	Indoor	Luminous Flux	110 lm/W
Light source color	2700 K → 6000 K	Mounting	Surface mounted/ Pendant	Power	4 W–20 W/m
Cap-Base	22cm	Trimless	N/A	Colour Temperature	2700 K → 6000 K
Light source replacable	Yes	Warranty Period	2 years	Length	2.5 cm → 50 cm
Luminaire light beam	120°			Width	0.8 cm

PLD 5010

WALTZ



Physical Specifications		Physical Specifications		Options	
Structure	Extruded Aluminum	Finishing	Aluminum anodized/RAL	Length	On request
Reflector	N/A	Weight	–	Finish	RAL on request
Optical Cover	PC Opal	Body	Extruded Aluminum	Dimmable	On request
Fixation material	Aluminum/Stainless Steel	Diffuser	PC Opal	Trimless	N/A
A	On request	UV Protection	Yes	Colour Temperature	2700K → 6000K
B	25 mm			IP Rate	IP44
C	20 mm				

Electrical Specifications		Performance		Remarks	
Input Voltage	220–240V	Power	4W - 20W/m	Customized length	
Input Frequency	50–60 hz	Luminous Flux	400lm - 2000 lm/m	Angular shapes	
Dimmable	On request	Luminous flux tolerance	10%	RGB version	
Output	24V	Colour Temperature	2700 K → 6000 K		
IP Rate	IP20-IP67	Colour Rendering Index	≥80		
Power Factor	–	LED Luminaire Efficacy	100 lm/W		
Power	–				

PLD 5020

CIRI

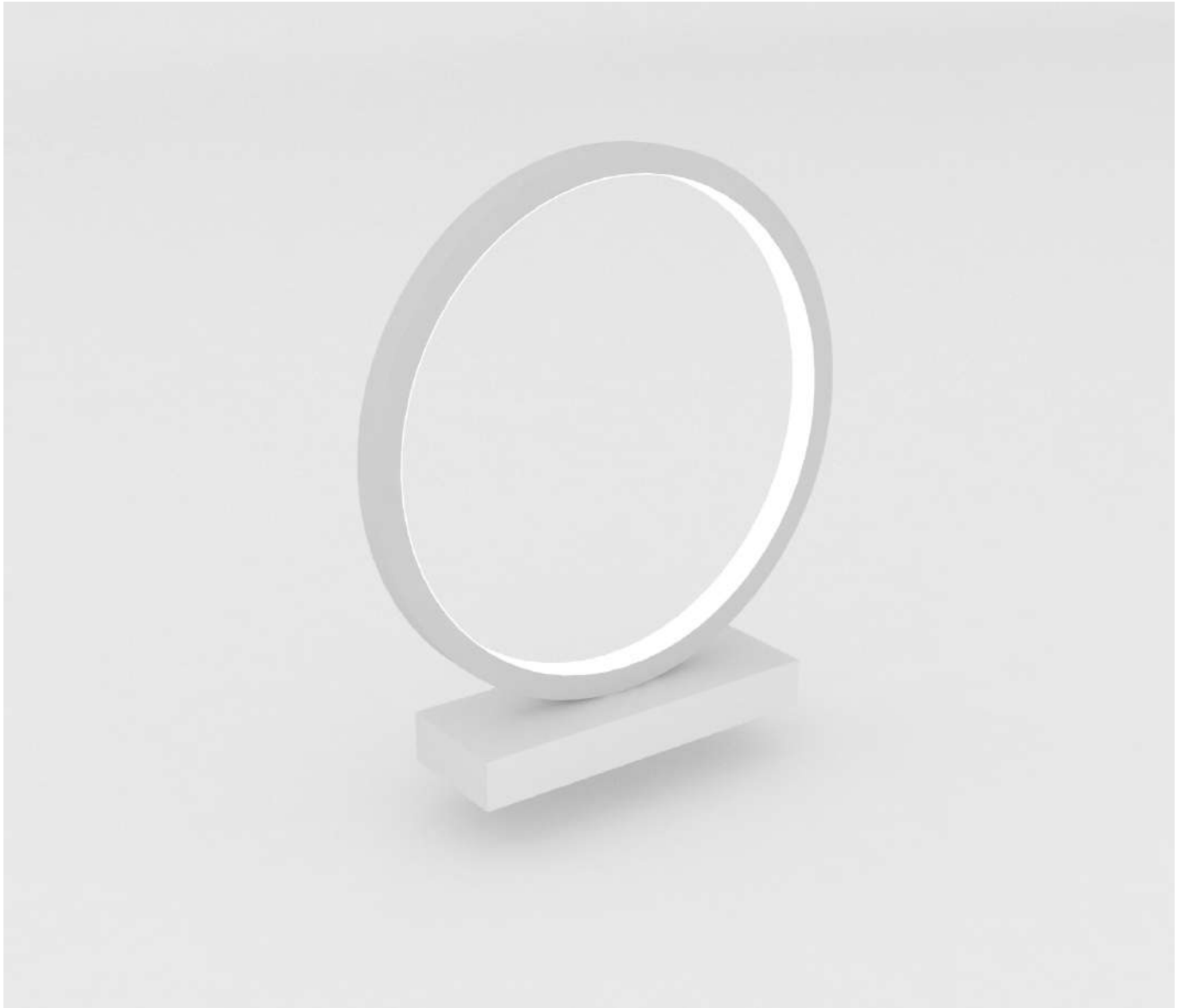

Product	
Code	PLD 5020
Name	CIRI
Categories	PROFIL
Subcategory	Linear
Type	Decorative
Type	Table lamp
Length	< 5 M
Finishing	RAL on request

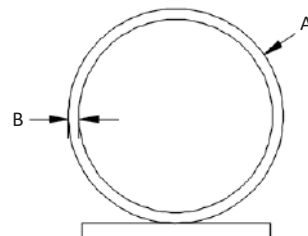

Product Specifications		General Information		Lamp Specifications	
Product Code	PLD 5020	Suspension System	N/A	Lamp Type	LED
Body	Extruded Aluminum	Protection	IP40	LED Chip	Samsung
Number of light source	1	Installation	Indoor	Luminous Flux	110 lm/W
Light source color	2700 K → 6000 K	Mounting	Stand alone	Power	4 W–20 W/m
Cap-Base	22 cm	Trimless	N/A	Colour Temperature	2700 K → 6000 K
Light source replacable	Yes	Warranty Period	2 years	Length	2.5 cm → 50 cm
Luminaire light beam	120°			Width	0.8 cm



PLD 5020

CIRI



Physical Specifications		Physical Specifications		Options	
Structure	Extruded Aluminum	Finishing	Aluminum anodized/RAL	Diameter	On request
Reflector	N/A	Weight	–	Finish	RAL on request
Optical Cover	PC Opal	Body	Extruded Aluminum	Dimmable	On request
Fixation material	Aluminum/Stainless Steel	Diffuser	PC Opal	Trimless	N/A
A	50cm - 60cm - 70cm	UV Protection	Yes	Colour Temperature	2700K → 6000K
B	2cm			IP Rate	IP44

Electrical Specifications		Performance		Remarks
Input Voltage	220–240V	Power	22W - 26W - 30W	Customized length
Input Frequency	50–60 hz	Luminous Flux	2200 lm–2600 - 3000lm	Angular shapes
Dimmable	On request	Luminous flux tolerance	10%	RGB version
Output	24V	Colour Temperature	2700 K → 6000 K	
IP Rate	IP20-IP67	Colour Rendering Index	≥80	
Power Factor	–	LED Luminaire Efficacy	100 lm/W	
Power	–			

PLD 5030

OVO



Product	
Code	PLD 5030
Name	OVO
Categories	PROFIL
Subcategory	Linear
	Decorative
Type	Wall lamp
	Ceiling lamp
Length	< 5 M
Finishing	RAL on request

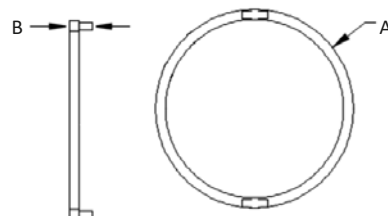

Product Specifications		General Information		Lamp Specifications	
Product Code	PLD 5030	Suspension System	N/A	Lamp Type	LED
Body	Extruded Aluminum	Protection	IP40	LED Chip	Samsung
Number of light source	1	Installation	Indoor	Luminous Flux	110 lm/W
Light source color	2700 K → 6000 K	Mounting	Wall & ceiling mounted	Power	4 W–20 W/m
Cap-Base	22 cm	Trimless	N/A	Colour Temperature	2700 K → 6000 K
Light source replacable	Yes	Warranty Period	2 years	Length	2.5 cm → 50 cm
Luminaire light beam	120°			Width	0.8 cm

PLD 5030

OVO

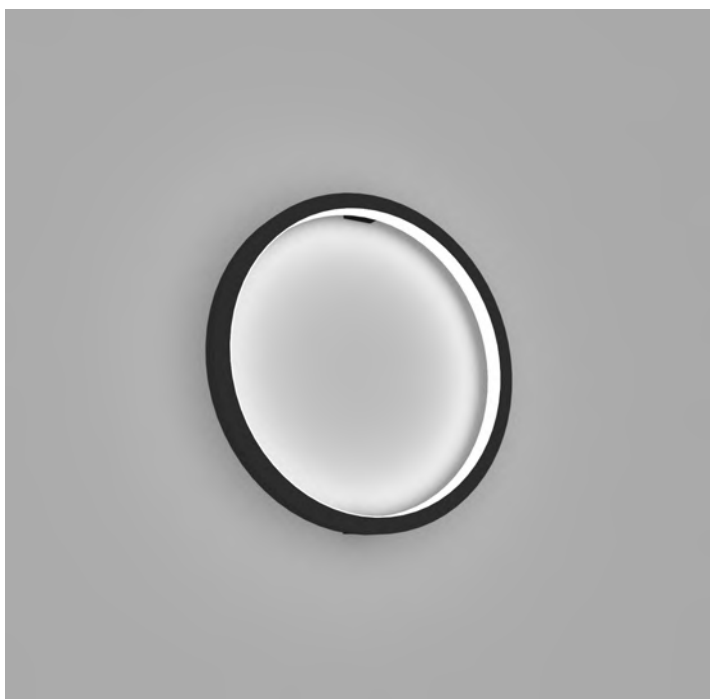
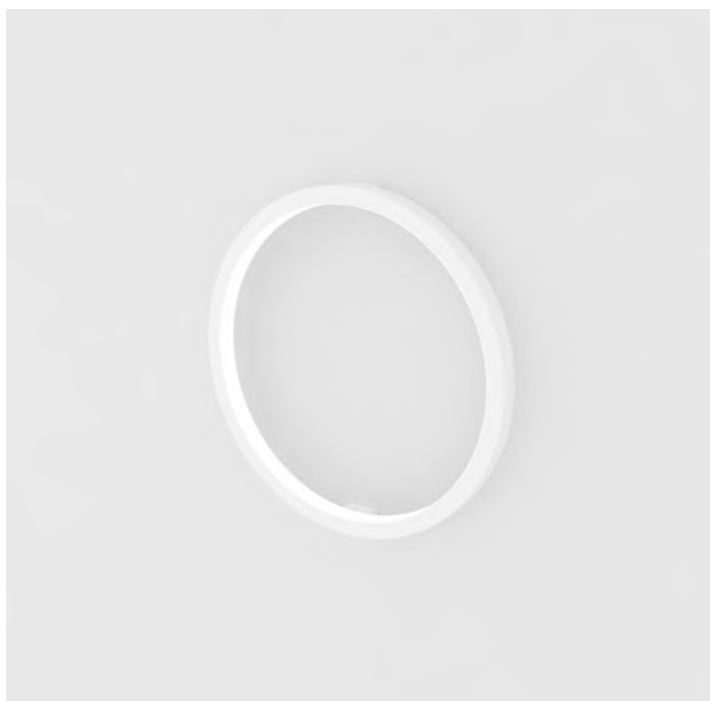

Physical Specifications		Physical Specifications		Options	
Structure	Extruded Aluminum	Finishing	Aluminum anodized/RAL	Diameter	On request
Reflector	N/A	Weight	–	Finish	RAL on request
Optical Cover	PC Opal	Body	Extruded Aluminum	Dimmable	On request
Fixation material	Aluminum/Stainless Steel	Diffuser	PC Opal	Trimless	N/A
A	50cm - 60cm - 70cm	UV Protection	Yes	Colour Temperature	2700K -> 6000K
B	7cm			IP Rate	IP44

Electrical Specifications		Performance		Remarks	
Input Voltage	220-240V	Power	22W - 26W - 30W	Customized length	
Input Frequency	50-60 hz	Luminous Flux	2200 lm-2600 - 3000lm	Angular shapes	
Dimmable	On request	Luminous flux tolerance	10%	RGB version	
Output	24V	Colour Temperature	2700 K -> 6000 K		
IP Rate	IP20-IP67	Colour Rendering Index	≥80		
Power Factor	–	LED Luminaire Efficacy	100 lm/W		
Power	–				

PLD 5040

TALA

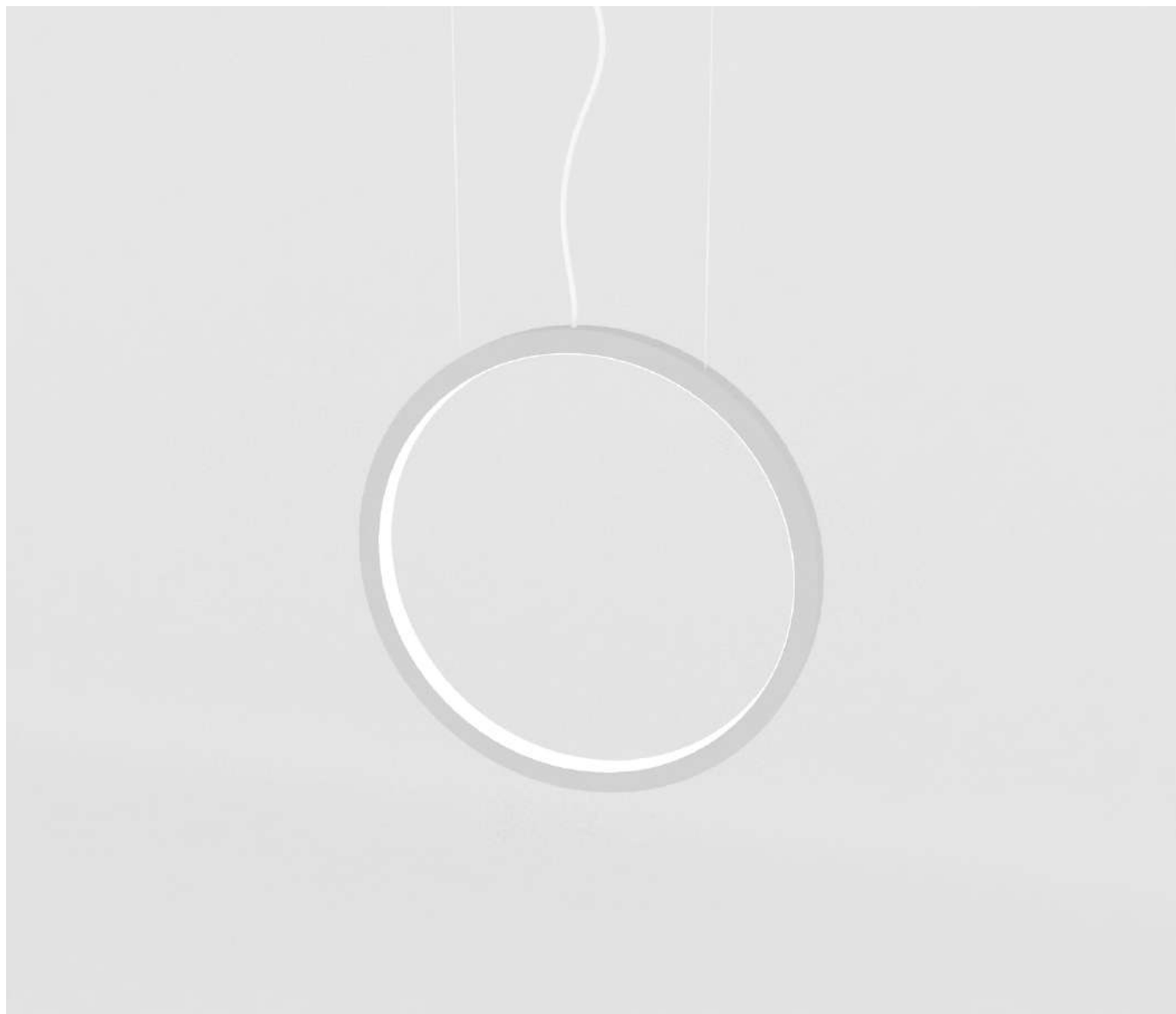

Product	
Code	PLD 5040
Name	TALA
Categories	PROFIL
Subcategory	Linear
	Decorative
Type	Pendant
Length	< 5 M
Finishing	RAL on request

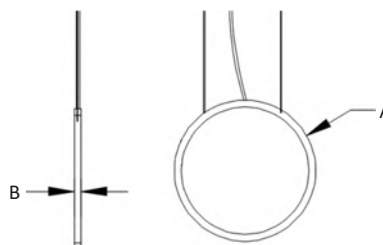

Product Specifications		General Information		Lamp Specifications	
Product Code	PLD 5040	Suspension System	2 wire set	Lamp Type	LED
Body	Extruded Aluminum	Protection	IP40	LED Chip	Samsung
Number of light source	1	Installation	Indoor	Luminous Flux	110 lm/W
Light source color	2700 K → 6000 K	Mounting	Pendant	Power	4 W–20 W/m
Cap-Base	22cm	Trimless	N/A	Colour Temperature	2700 K → 6000 K
Light source replacable	Yes	Warranty Period	2 years	Length	2.5 cm → 50 cm
Luminaire light beam	120°			Width	0.8 cm

PLD 5040

TALA

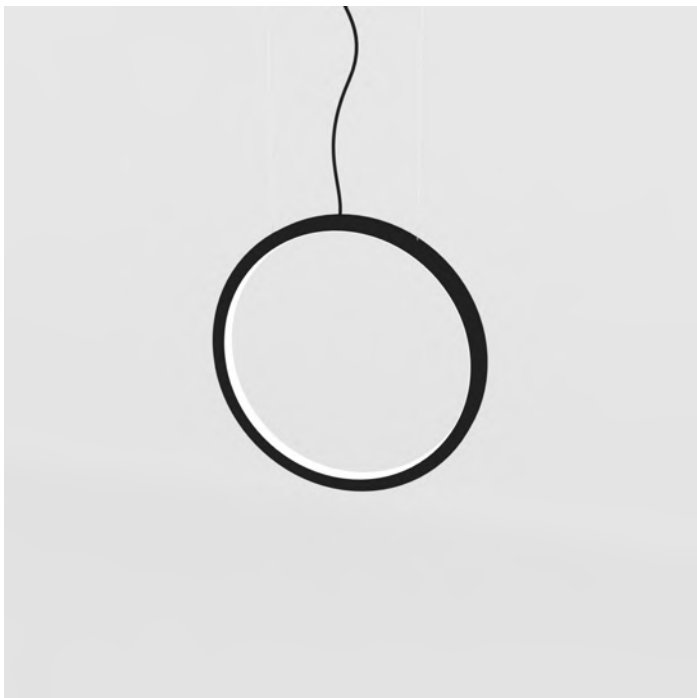
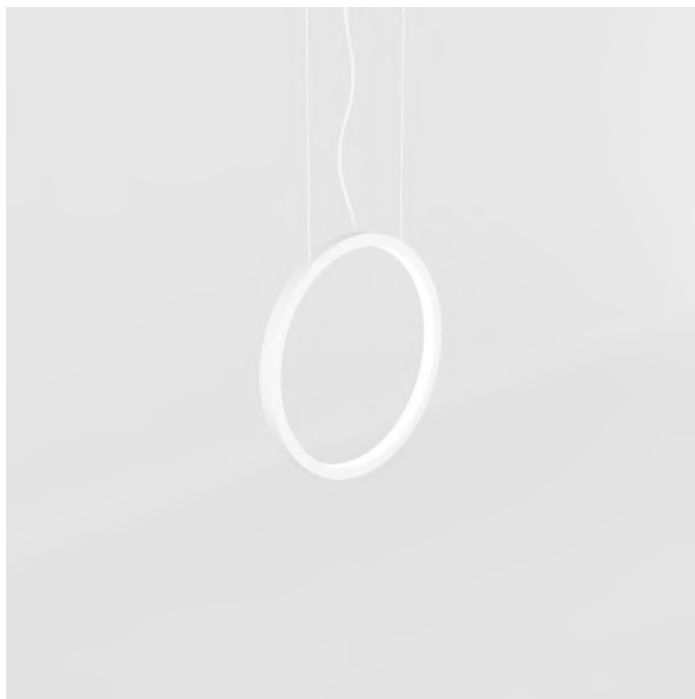

Physical Specifications		Physical Specifications		Options	
Structure	Extruded Aluminum	Finishing	Aluminum anodized/RAL	Diameter	On request
Reflector	N/A	Weight	–	Finish	RAL on request
Optical Cover	PC Opal	Body	Extruded Aluminum	Dimmable	On request
Fixation material	Aluminum/Stainless Steel	Diffuser	PC Opal	Trimless	N/A
A	50cm - 60cm - 70cm	UV Protection	Yes	Colour Temperature	2700K -> 6000K
B	2.5cm			IP Rate	IP44

Electrical Specifications		Performance		Remarks	
Input Voltage	220-240V	Power	22W - 26W - 30W	Customized length	
Input Frequency	50-60 hz	Luminous Flux	2200 lm-2600 - 3000lm	Angular shapes	
Dimmable	On request	Luminous flux tolerance	10%	RGB version	
Output	24V	Colour Temperature	2700 K -> 6000 K		
IP Rate	IP20-IP67	Colour Rendering Index	≥80		
Power Factor	–	LED Luminaire Efficacy	100 lm/W		
Power	–				

PLD 5050

RONA



Product	
Code	PLD 5050
Name	RONA
Categories	PROFIL
Subcategory	Linear
	Decorative
Type	Pendant
	Ceiling lamp
Length	< 5 M
Finishing	RAL on request

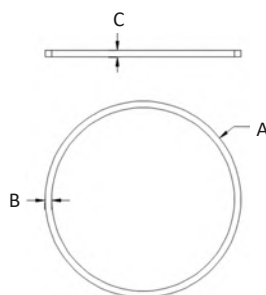

Product Specifications		General Information		Lamp Specifications	
Product Code	PLD 5050	Suspension System	3 wire set	Lamp Type	LED
Body	Extruded Aluminum	Protection	IP40	LED Chip	Samsung
Number of light source	1	Installation	Indoor	Luminous Flux	110 lm/W
Light source color	2700 K -> 6000 K	Mounting	Surface mounted/ Pendant	Power	4 W-20 W/m
Cap-Base	22cm	Trimless	N/A	Colour Temperature	2700 K -> 6000 K
Light source replacable	Yes	Warranty Period	2 years	Length	2.5 cm -> 50 cm
Luminaire light beam	120°			Width	0.8 cm

PLD 5050

RONA

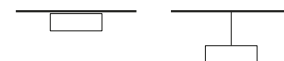

Physical Specifications		Physical Specifications		Options	
Structure	Extruded Aluminum	Finishing	Aluminum anodized/RAL	Diameter	On request
Reflector	N/A	Weight	-	Finish	RAL on request
Optical Cover	PC Opal	Body	Extruded Aluminum	Dimmable	On request
Fixation material	Aluminum/Stainless Steel	Diffuser	PC Opal	Trimless	N/A
A	70cm - 100cm, 150cm	UV Protection	Yes	Colour Temperature	2700K -> 6000K
B	2cm			IP Rate	IP44
C	2.5cm				
Electrical Specifications		Performance		Remarks	
Input Voltage	220-240V	Power	30W - 45W - 66W	Customized length	
Input Frequency	50-60 hz	Luminous Flux	3000lm - 4500 lm - 6600lm	Angular shapes	
Dimmable	On request	Luminous flux tolerance	10%	RGB version	
Output	24V	Colour Temperature	2700 K -> 6000 K		
IP Rate	IP20-IP67	Colour Rendering Index	≥80		
Power Factor	-	LED Luminaire Efficacy	100 lm/W		
Power	-				

PLD 5060

VENUS



Product	
Code	PLD 5060
Name	VENUS
Categories	PROFIL
Subcategory	Linear
	Decorative
Type	Pendant
	Ceiling lamp
Length	< 5 M
Finishing	RAL on request

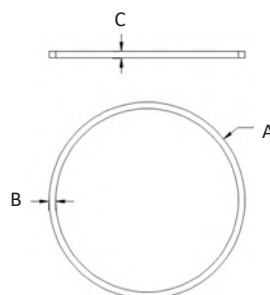

Product Specifications		General Information		Lamp Specifications	
Product Code	PLD 5060	Suspension System	3 wire set	Lamp Type	LED
Body	Extruded Aluminum	Protection	IP40	LED Chip	Samsung
Number of light source	1	Installation	Indoor	Luminous Flux	110 lm/W
Light source color	2700 K -> 6000 K	Mounting	Surface mounted/ Pendant	Power	4 W-20 W/m
Cap-Base	22cm	Trimless	N/A	Colour Temperature	2700 K -> 6000 K
Light source replacable	Yes	Warranty Period	2 years	Length	2.5 cm -> 50 cm
Luminaire light beam	120°			Width	0.8 cm

PLD 5060

VENUS

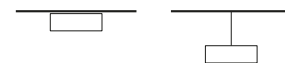

Physical Specifications		Physical Specifications		Options	
Structure	Extruded Aluminum	Finishing	Aluminum anodized/RAL	Diameter	On request
Reflector	N/A	Weight	-	Finish	RAL on request
Optical Cover	PC Opal	Body	Extruded Aluminum	Dimmable	On request
Fixation material	Aluminum/Stainless Steel	Diffuser	PC Opal	Trimless	N/A
Length	70cm - 100cm, 150cm	UV Protection	Yes	Colour Temperature	2700K -> 6000K
Diameter	2cm			IP Rate	IP44
Height	2.5cm				

Electrical Specifications		Performance		Remarks	
Input Voltage	220-240V	Power	30W - 45W - 66W	Customized length	
Input Frequency	50-60 hz	Luminous Flux	3000lm - 4500 lm - 6600lm	Angular shapes	
Dimmable	On request	Luminous flux tolerance	10%	RGB version	
Output	24V	Colour Temperature	2700 K -> 6000 K		
IP Rate	IP20-IP67	Colour Rendering Index	≥80		
Power Factor	-	LED Luminaire Efficacy	100 lm/W		
Power	-				

PLD 5500

FORM

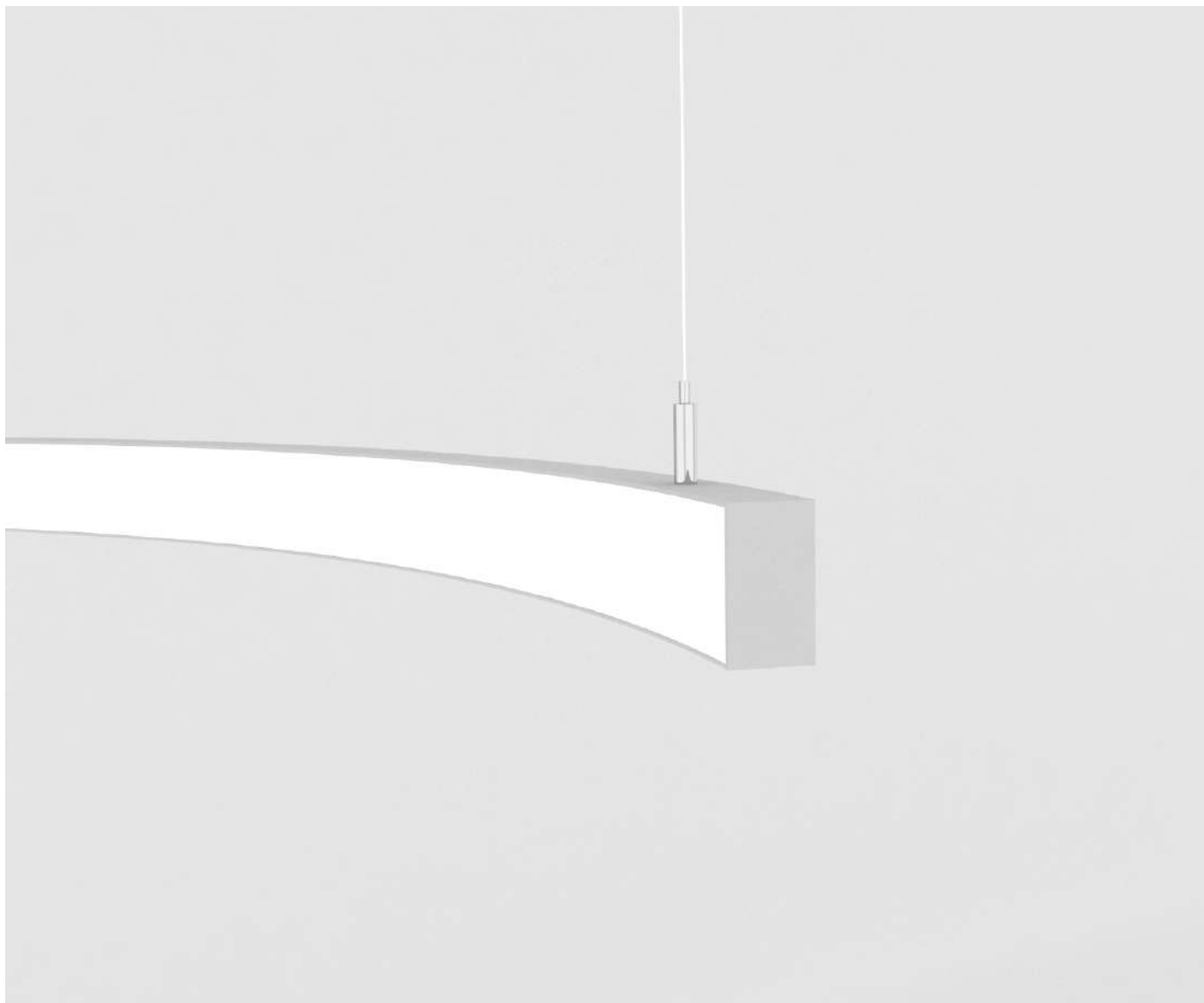

Product	
Code	PLD 5500
Name	FORM
Categories	PROFIL
Subcategory	Linear
	Decorative
Type	Pendant
	Ceiling lamp
Length	< 5 M
Finishing	RAL on request

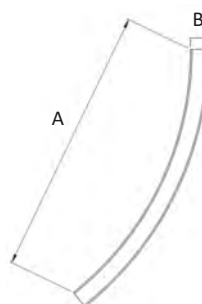

Product Specifications		General Information		Lamp Specifications	
Product Code	PLD 5500	Suspension System	3 wire set	Lamp Type	LED
Body	Extruded Aluminum	Protection	IP40	LED Chip	Samsung
Number of light source	2	Installation	Indoor	Luminous Flux	110 lm/W
Light source color	2700 K → 6000 K	Mounting	Surface mounted/ Pendant	Power	4 W-20 W/m
Cap-Base	22cm	Trimless	N/A	Colour Temperature	2700 K → 6000 K
Light source replacable	Yes	Warranty Period	2 years	Length	2.5 cm → 50 cm
Luminaire light beam	120°			Width	0.8 cm

PLD 5500

FORM

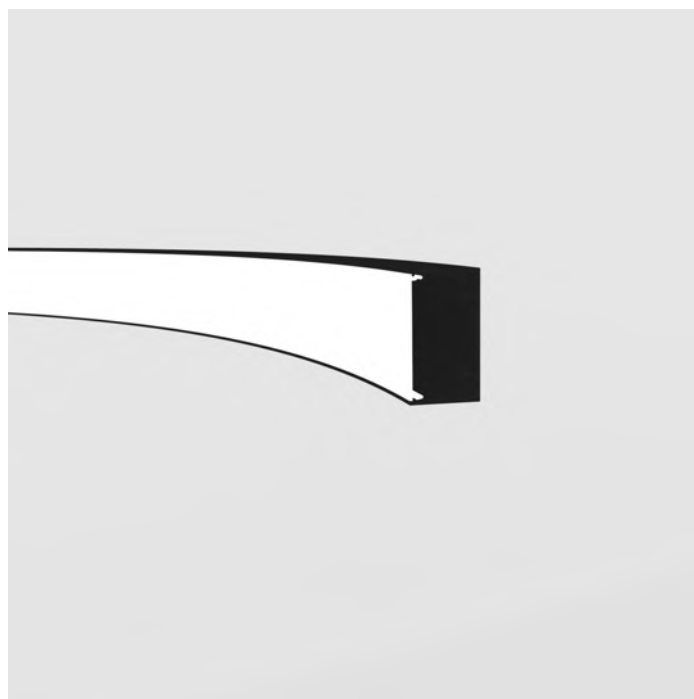
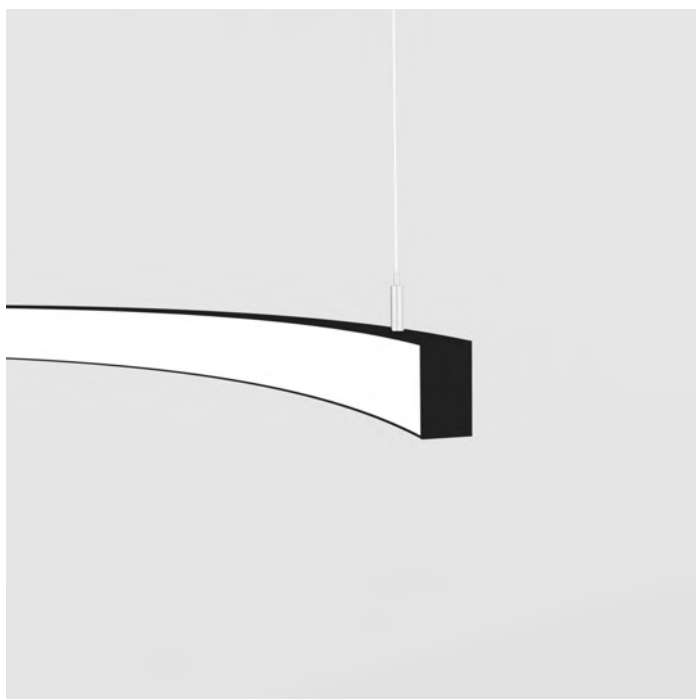
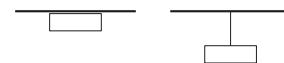

Physical Specifications		Physical Specifications		Options	
Structure	Extruded Aluminum	Finishing	Aluminum anodized/RAL	Length	On request
Reflector	N/A	Weight	-	Finish	RAL on request
Optical Cover	PC Opal	Body	Extruded Aluminum	Dimmable	On request
Fixation material	Aluminum/Stainless Steel	Diffuser	PC Opal	Trimless	N/A
A	On request	UV Protection	Yes	Colour Temperature	2700K -> 6000K
B	6.1cm			IP Rate	IP44

Electrical Specifications		Performance		Remarks	
Input Voltage	220-240V	Power	8W - 40W/m	Customized length	
Input Frequency	50-60 hz	Luminous Flux	800lm - 4000 lm/m	Angular shapes	
Dimmable	On request	Luminous flux tolerance	10%	RGB version	
Output	24V	Colour Temperature	2700 K -> 6000 K		
IP Rate	IP20-IP67	Colour Rendering Index	≥80		
Power Factor	-	LED Luminaire Efficacy	100 lm/W		
Power	-				

PLD 5505

WAVE



Product	
Code	PLD 5505
Name	WAVE
Categories	PROFIL
Subcategory	Linear
	Decorative
Type	Pendant
	Ceiling lamp
Length	< 5 M
Finishing	RAL on request

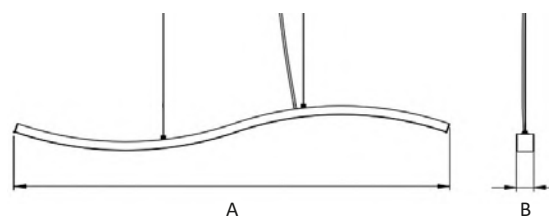

Product Specifications		General Information		Lamp Specifications	
Product Code	PLD 5505	Suspension System	2 wire set	Lamp Type	LED
Body	Extruded Aluminum	Protection	IP40	LED Chip	Samsung
Number of light source	2	Installation	Indoor	Luminous Flux	110 lm/W
Light source color	2700 K → 6000 K	Mounting	Surface mounted/ Pendant	Power	4 W-20 W/m
Cap-Base	22cm	Trimless	N/A	Colour Temperature	2700 K → 6000 K
Light source replacable	Yes	Warranty Period	2 years	Length	2.5 cm → 50 cm
Luminaire light beam	120°			Width	0.8 cm

PLD 5505

WAVE

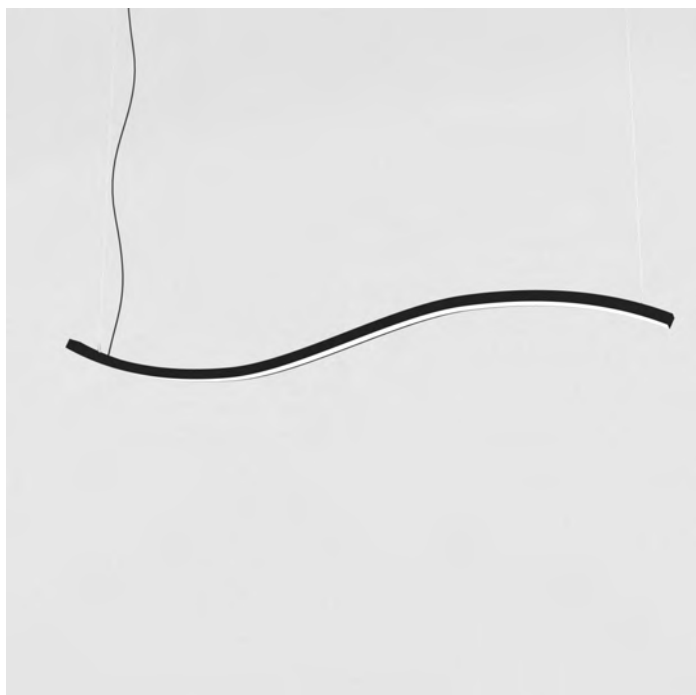

Physical Specifications		Physical Specifications		Options	
Structure	Extruded Aluminum	Finishing	Aluminum anodized/RAL	Length	On request
Reflector	N/A	Weight	-	Finish	RAL on request
Optical Cover	PC Opal	Body	Extruded Aluminum	Dimmable	On request
Fixation material	Aluminum/Stainless Steel	Diffuser	PC Opal	Trimless	N/A
A	On request	UV Protection	Yes	Colour Temperature	2700K → 6000K
B	6.1cm			IP Rate	IP44

Electrical Specifications		Performance		Remarks
Input Voltage	220-240V	Power	8W - 40W/m	Customized length
Input Frequency	50-60 hz	Luminous Flux	800lm - 4000 lm/m	Angular shapes
Dimmable	On request	Luminous flux tolerance	10%	RGB version
Output	24V	Colour Temperature	2700 K → 6000 K	
IP Rate	IP20-IP67	Colour Rendering Index	≥80	
Power Factor	-	LED Luminaire Efficacy	100 lm/W	
Power	-			

PLD 5510

SHAPE

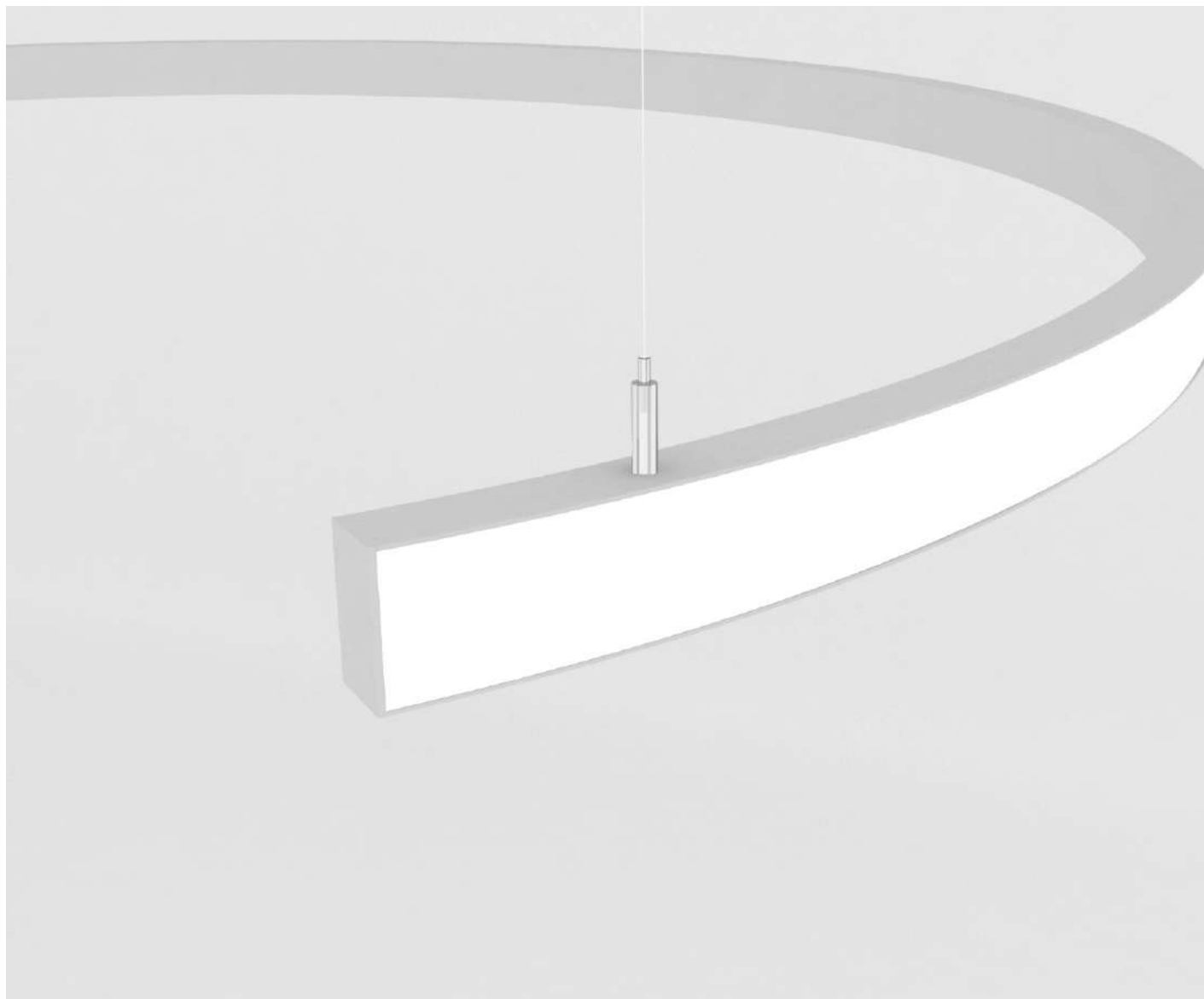

Product	
Code	PLD 5510
Name	SHAPE
Categories	PROFIL
Subcategory	Linear
	Decorative
Type	Pendant
	Ceiling lamp
Length	< 5 M
Finishing	RAL on request

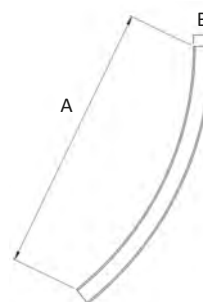

Product Specifications		General Information		Lamp Specifications	
Product Code	PLD 5510	Suspension System	2 wire set	Lamp Type	LED
Body	Extruded Aluminum	Protection	IP40	LED Chip	Samsung
Number of light source	2	Installation	Indoor	Luminous Flux	110 lm/W
Light source color	2700 K -> 6000 K	Mounting	Surface mounted/ Pendant	Power	4 W-20 W/m
Cap-Base	22cm	Trimless	N/A	Colour Temperature	2700 K -> 6000 K
Light source replacable	Yes	Warranty Period	2 years	Length	2.5 cm -> 50 cm
Luminaire light beam	120°			Width	0.8 cm

PLD 5510

SHAPE

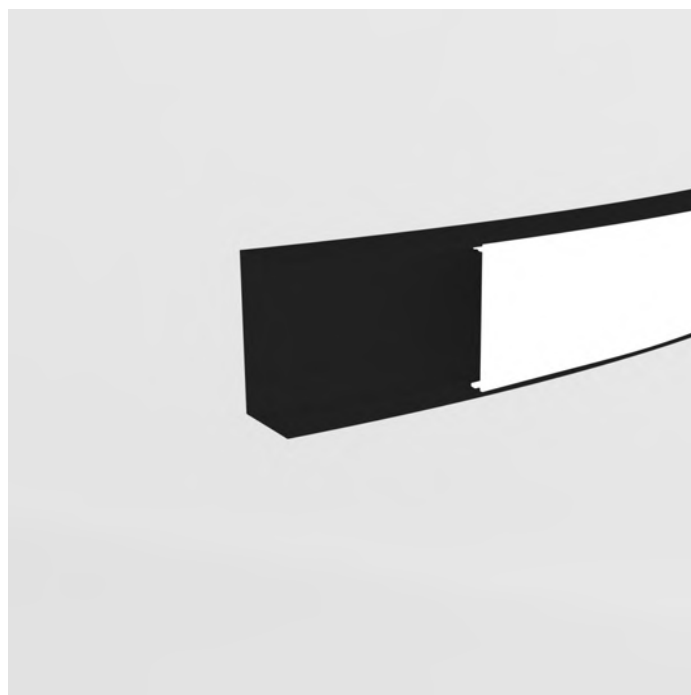
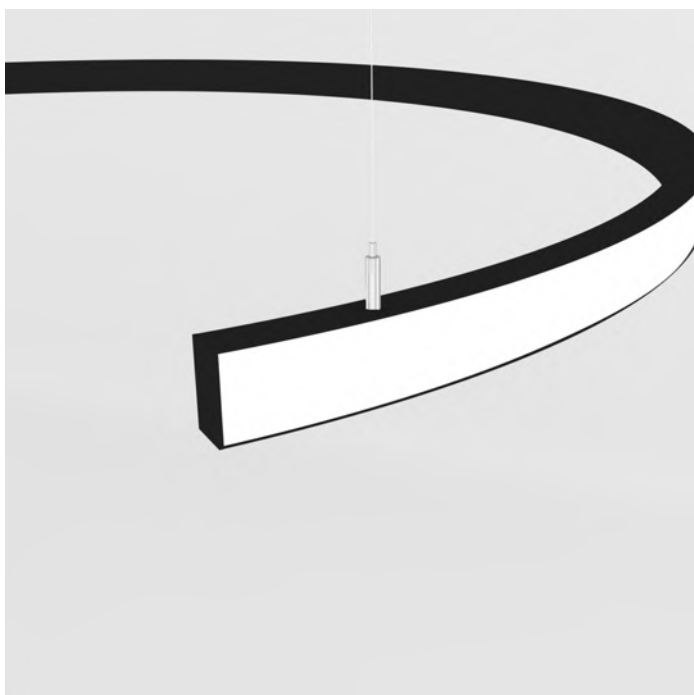
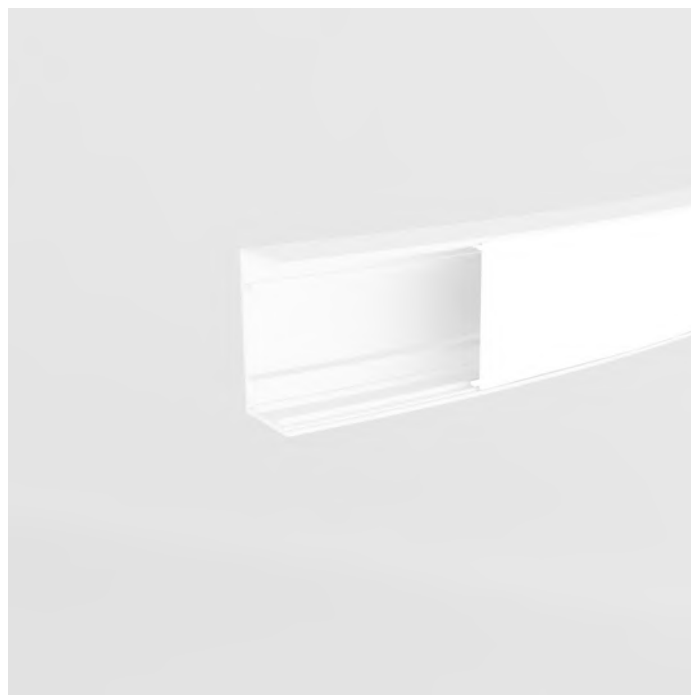
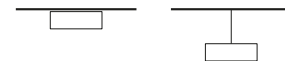

Physical Specifications		Physical Specifications		Options	
Structure	Extruded Aluminum	Finishing	Aluminum anodized/RAL	Length	On request
Reflector	N/A	Weight	-	Finish	RAL on request
Optical Cover	PC Opal	Body	Extruded Aluminum	Dimmable	On request
Fixation material	Aluminum/Stainless Steel	Diffuser	PC Opal	Trimless	N/A
A	On request	UV Protection	Yes	Colour Temperature	2700K → 6000K
B	6.1cm			IP Rate	IP44

Electrical Specifications		Performance		Remarks	
Input Voltage	220-240V	Power	8W - 40W/m	Customized length	
Input Frequency	50-60 Hz	Luminous Flux	800lm - 4000 lm/m	Angular shapes	
Dimmable	On request	Luminous flux tolerance	10%	RGB version	
Output	24V	Colour Temperature	2700 K → 6000 K		
IP Rate	IP20-IP67	Colour Rendering Index	≥80		
Power Factor	-	LED Luminaire Efficacy	100 lm/W		
Power	-				

PLD 5550

KIRA



Product	
Code	PLD 5550
Name	KIRA
Categories	PROFIL
Subcategory	Linear
	Decorative
Type	Pendant
	Ceiling lamp
Length	< 5 M
Finishing	RAL on request

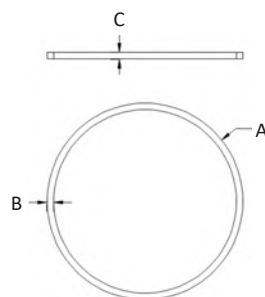

Product Specifications		General Information		Lamp Specifications	
Product Code	PLD 5550	Suspension System	3 wire set	Lamp Type	LED
Body	Extruded Aluminum	Protection	IP40	LED Chip	Samsung
Number of light source	2	Installation	Indoor	Luminous Flux	110 lm/W
Light source color	2700 K → 6000 K	Mounting	Surface mounted/ Pendant	Power	4 W–20 W/m
Cap-Base	22cm	Trimless	N/A	Colour Temperature	2700 K → 6000 K
Light source replacable	Yes	Warranty Period	2 years	Length	2.5 cm → 50 cm
Luminaire light beam	120°			Width	0.8 cm

PLD 5550

KIRA

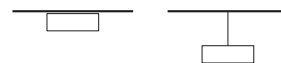

Physical Specifications		Physical Specifications		Options	
Structure	Extruded Aluminum	Finishing	Aluminum anodized/RAL	Diameter	On request
Reflector	N/A	Weight	-	Finish	RAL on request
Optical Cover	PC Opal	Body	Extruded Aluminum	Dimmable	On request
Fixation material	Aluminum/Stainless Steel	Diffuser	PC Opal	Trimless	N/A
A	50cm - 100cm, 150cm	UV Protection	Yes	Colour Temperature	2700K -> 6000K
B	6.1cm			IP Rate	IP44
C	3.4cm				
Electrical Specifications		Perfomance		Remarks	
Input Voltage	220-240V	Power	45W - 90W - 135W	Customized length	
Input Frequency	50-60 hz	Luminous Flux	4500lm - 9000 lm - 13000lm	Angular shapes	
Dimmable	On request	Luminous flux tolerance	10%	RGB version	
Output	24V	Colour Temperature	2700 K -> 6000 K		
IP Rate	IP20-IP67	Colour Rendering Index	≥80		
Power Factor	-	LED Luminaire Efficacy	100 lm/W		
Power	-				

PLD 5560

ZODA



Product	
Code	PLD 5560
Name	ZODA
Categories	PROFIL
Subcategory	Linear
	Decorative
Type	Pendant
	Ceiling lamp
Length	< 5 M
Finishing	RAL on request

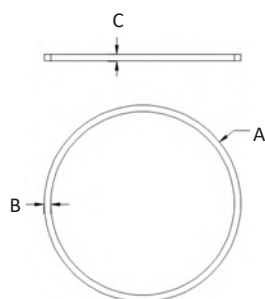

Product Specifications		General Information		Lamp Specifications	
Product Code	PLD 5560	Suspension System	3 wire set	Lamp Type	LED
Body	Extruded Aluminum	Protection	IP40	LED Chip	Samsung
Number of light source	2	Installation	Indoor	Luminous Flux	110 lm/W
Light source color	2700 K → 6000 K	Mounting	Surface mounted/ Pendant	Power	4 W-20 W/m
Cap-Base	22cm	Trimless	N/A	Colour Temperature	2700 K → 6000 K
Light source replacable	Yes	Warranty Period	2 years	Length	2.5 cm → 50 cm
Luminaire light beam	120°			Width	0.8 cm

PLD 5560

ZODA

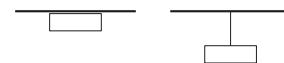

Physical Specifications		Physical Specifications		Options	
Structure	Extruded Aluminum	Finishing	Aluminum anodized/RAL	Diameter	On request
Reflector	N/A	Weight	-	Finish	RAL on request
Optical Cover	PC Opal	Body	Extruded Aluminum	Dimmable	On request
Fixation material	Aluminum/Stainless Steel	Diffuser	PC Opal	Trimless	N/A
A	50cm - 100cm, 150cm	UV Protection	Yes	Colour Temperature	2700K -> 6000K
B	6.1cm			IP Rate	IP44
C	3.4cm				
Electrical Specifications		Performance		Remarks	
Input Voltage	220-240V	Power	45W - 90W - 135W	Customized length	
Input Frequency	50-60 hz	Luminous Flux	4500lm - 9000 lm - 13000lm	Angular shapes	
Dimmable	On request	Luminous flux tolerance	10%	RGB version	
Output	24V	Colour Temperature	2700 K -> 6000 K		
IP Rate	IP20-IP67	Colour Rendering Index	≥80		
Power Factor	-	LED Luminaire Efficacy	100 lm/W		
Power	-				

PLD 6000

COCKTAIL

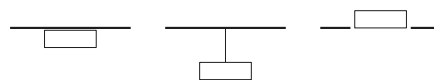

Product	
Code	PLD 6000
Name	COCKTAIL
Categories	PROFIL
Subcategory	Linear
	Decorative
Type	Pendant
	Ceiling lamp
	Trimless
Length	< 5 M
Finishing	RAL on request

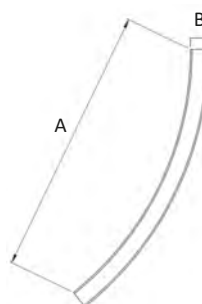

Product Specifications		General Information		Lamp Specifications	
Product Code	PLD 6000	Suspension System	2 wire set	Lamp Type	LED
Body	Extruded Aluminum	Protection	IP40	LED Chip	Samsung
Number of light source	2	Installation	Indoor	Luminous Flux	110 lm/W
Light source color	2700 K → 6000 K	Mounting	Surface mounted/ Pendant	Power	4 W-20 W/m
Cap-Base	22 cm	Trimless	On request	Colour Temperature	2700 K → 6000 K
Light source replacable	Yes	Warranty Period	2 years	Length	2.5 cm → 50 cm
Luminaire light beam	120°			Width	0.8 cm

PLD 6000

COCKTAIL

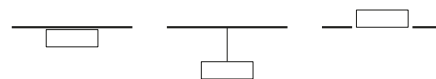

Physical Specifications		Physical Specifications		Options	
Structure	Extruded Aluminum	Finishing	Aluminum anodized/RAL	Length	On request
Reflector	N/A	Weight	-	Finish	RAL on request
Optical Cover	PC Opal/Micropismatic	Body	Extruded Aluminum	Dimmable	On request
Fixation material	Aluminum/Stainless Steel	Diffuser	PC Opal	Trimless	On request
A	On request	UV Protection	Yes	Colour Temperature	2700K -> 6000K
B	80 mm			IP Rate	IP44

Electrical Specifications		Performance		Remarks	
Input Voltage	220-240V	Power	8W-40W/m	Customized length	
Input Frequency	50-60 hz	Luminous Flux	800 lm-4000 lm/m	Angular shapes	
Dimmable	On request	Luminous flux tolerance	10%	RGB version	
Output	24V	Colour Temperature	2700 K -> 6000 K		
IP Rate	IP20-IP67	Colour Rendering Index	≥80		
Power Factor	-	LED Luminaire Efficacy	100 lm/W		
Power	-				

PLD 6050

OBY

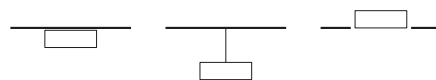

Product	
Code	PLD 6050
Name	OBY
Categories	PROFIL
Subcategory	Linear
	Decorative
Type	Pendant
	Ceiling lamp
	Trimless
Length	< 5 M
Finishing	RAL on request

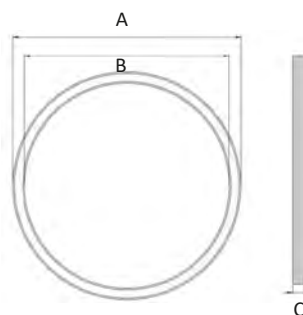

Product Specifications		General Information		Lamp Specifications	
Product Code	PLD 6050	Suspension System	3 wire set	Lamp Type	LED
Body	Extruded Aluminum	Protection	IP40	LED Chip	Samsung
Number of light source	2	Installation	Indoor	Luminous Flux	110 lm/W
Light source color	2700 K → 6000 K	Mounting	Surface mounted/ Pendant	Power	4 W-20 W/m
Cap-Base	22 cm	Trimless	On request	Colour Temperature	2700 K → 6000 K
Light source replacable	Yes	Warranty Period	2 years	Length	2.5 cm → 50 cm
Luminaire light beam	120°			Width	0.8 cm

PLD 6050

OBY

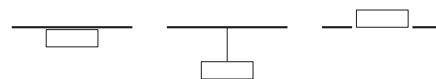

Physical Specifications		Physical Specifications		Options	
Structure	Extruded Aluminum	Finishing	Aluminum anodized/RAL	Diameter	On request
Reflector	N/A	Weight	-	Finish	RAL on request
Optical Cover	Opal Plexiglass	Body	Extruded Aluminum	Dimmable	On request
Fixation material	Aluminum/Stainless Steel	Diffuser	Opal Plexiglass	Trimless	On request
A	62cm - 82cm - 112cm	UV Protection	Yes	Colour Temperature	2700K → 6000K
B	46cm - 66cm - 96cm			IP Rate	IP44
C	8.5cm				
Electrical Specifications		Performance		Remarks	
Input Voltage	220-240V	Power	35W - 50W - 70W	Customized length	
Input Frequency	50-60 hz	Luminous Flux	3500 lm - 5000 lm - 7000lm	Angular shapes	
Dimmable	On request	Luminous flux tolerance	10%	RGB version	
Output	24V	Colour Temperature	2700 K → 6000 K		
IP Rate	IP20-IP67	Colour Rendering Index	≥80		
Power Factor	-	LED Luminaire Efficacy	100 lm/W		
Power	-				

PLD 6100

PRIME

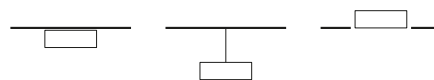

Product	
Code	PLD 6100
Name	PRIME
Categories	PROFIL
Subcategory	Linear
	Decorative
Type	Pendant
	Ceiling lamp
	Trimless
Length	< 5 M
Finishing	RAL on request

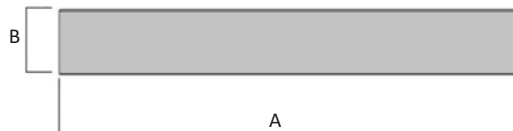

Product Specifications		General Information		Lamp Specifications	
Product Code	PLD 6100	Suspension System	3 wire set	Lamp Type	LED
Body	Extruded Aluminum	Protection	IP40	LED Chip	Samsung
Number of light source	1	Installation	Indoor	Luminous Flux	110 lm/W
Light source color	2700 K → 6000 K	Mounting	Surface mounted/ Pendant	Power	4 W–20 W/m
Cap-Base	22 cm	Trimless	On request	Colour Temperature	2700 K → 6000 K
Light source replacable	Yes	Warranty Period	2 years	Length	2.5 cm → 50 cm
Luminaire light beam	120°			Width	0.8 cm

PLD 6100

PRIME

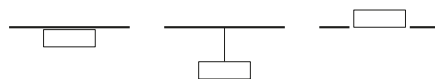

Physical Specifications		Physical Specifications		Options	
Structure	Extruded Aluminum	Finishing	Aluminum anodized/RAL	Diameter	On request
Reflector	N/A	Weight	-	Finish	RAL on request
Optical Cover	Opal Plexiglass	Body	Extruded Aluminum	Dimmable	On request
Fixation material	Aluminum/Stainless Steel	Diffuser	Opal Plexiglass	Trimless	On request
A	46cm - 66cm - 96cm	UV Protection	Yes	Colour Temperature	2700K -> 6000K
B	8.5cm			IP Rate	IP44

Electrical Specifications		Performance		Remarks	
Input Voltage	220-240V	Power	40W - 60W - 90W	Customized length	
Input Frequency	50-60 hz	Luminous Flux	4000 lm - 6000 lm - 9000lm	Angular shapes	
Dimmable	On request	Luminous flux tolerance	10%	RGB version	
Output	24V	Colour Temperature	2700 K -> 6000 K		
IP Rate	IP20-IP67	Colour Rendering Index	≥80		
Power Factor	-	LED Luminaire Efficacy	100 lm/W		
Power	-				

PLD 6150

SQUARE

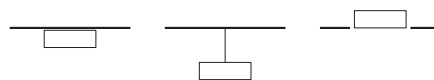

Product	
Code	PLD 6150
Name	SQUARE
Categories	PROFIL
Subcategory	Linear
	Decorative
Type	Pendant
	Ceiling lamp
	Trimless
Length	< 5 M
Finishing	RAL on request

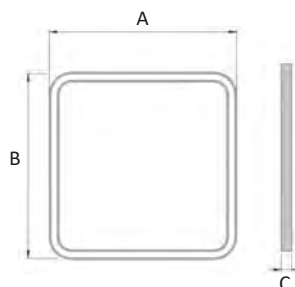

Product Specifications		General Information		Lamp Specifications	
Product Code	PLD 6150	Suspension System	4 wire set	Lamp Type	LED
Body	Extruded Aluminum	Protection	IP40	LED Chip	Samsung
Number of light source	2	Installation	Indoor	Luminous Flux	110 lm/W
Light source color	2700 K → 6000 K	Mounting	Surface mounted/ Pendant	Power	4 W–20 W/m
Cap-Base	22 cm	Trimless	On request	Colour Temperature	2700 K → 6000 K
Light source replacable	Yes	Warranty Period	2 years	Length	2.5 cm → 50 cm
Luminaire light beam	120°			Width	0.8 cm

PLD 6150

SQUARE

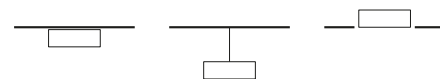

Physical Specifications		Physical Specifications		Options	
Structure	Extruded Aluminum	Finishing	Aluminum anodized/RAL	Length	On request
Reflector	N/A	Weight	-	Finish	RAL on request
Optical Cover	Opal Plexiglass	Body	Extruded Aluminum	Dimmable	On request
Fixation material	Aluminum/Stainless Steel	Diffuser	Opal Plexiglass	Trimless	On request
A	86cm - 116cm - 146cm	UV Protection	Yes	Colour Temperature	2700K -> 6000K
B	86cm - 116cm - 146cm			IP Rate	IP44
C	8.5cm				
Electrical Specifications		Performance		Remarks	
Input Voltage	220-240V	Power	65W - 90W - 115W	Customized length	
Input Frequency	50-60 Hz	Luminous Flux	6500 lm - 9000 lm - 11500lm	Angular shapes	
Dimmable	On request	Luminous flux tolerance	10%	RGB version	
Output	24V	Colour Temperature	2700 K -> 6000 K		
IP Rate	IP20-IP67	Colour Rendering Index	≥80		
Power Factor	-	LED Luminaire Efficacy	100 lm/W		
Power	-				

PLD 6200

BIGBANG

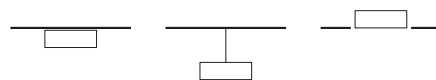

Product	
Code	PLD 6200
Name	BIGBANG
Categories	PROFIL
Subcategory	Linear
	Decorative
Type	Pendant
	Ceiling lamp
	Trimless
Length	< 5 M
Finishing	RAL on request

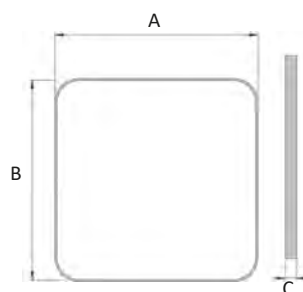

Product Specifications		General Information		Lamp Specifications	
Product Code	PLD 6200	Suspension System	4 wire set	Lamp Type	LED
Body	Extruded Aluminum	Protection	IP40	LED Chip	Samsung
Number of light source	1	Installation	Indoor	Luminous Flux	110 lm/W
Light source color	2700 K → 6000 K	Mounting	Surface mounted/ Pendant	Power	4 W–20 W/m
Cap-Base	22 cm	Trimless	On request	Colour Temperature	2700 K → 6000 K
Light source replacable	Yes	Warranty Period	2 years	Length	2.5 cm → 50 cm
Luminaire light beam	120°			Width	0.8 cm

PLD 6200

BIGBANG

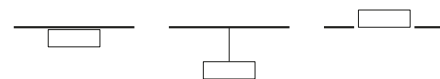

Physical Specifications		Physical Specifications		Options	
Structure	Extruded Aluminum	Finishing	Aluminum anodized/RAL	Length	On request
Reflector	N/A	Weight	-	Finish	RAL on request
Optical Cover	Opal Plexiglass	Body	Extruded Aluminum	Dimmable	On request
Fixation material	Aluminum/Stainless Steel	Diffuser	Opal Plexiglass	Trimless	On request
A	70cm - 100cm - 130cm	UV Protection	Yes	Colour Temperature	2700K → 6000K
B	70cm - 100cm - 130cm			IP Rate	IP44
C	8.5cm				

Electrical Specifications		Performance		Remarks	
Input Voltage	220-240V	Power	60W - 120W - 160W	Customized length	
Input Frequency	50-60 hz	Luminous Flux	6000 lm - 12000 lm - 16000lm	Angular shapes	
Dimmable	On request	Luminous flux tolerance	10%	RGB version	
Output	24V	Colour Temperature	2700 K → 6000 K		
IP Rate	IP20-IP67	Colour Rendering Index	≥80		
Power Factor	-	LED Luminaire Efficacy	100 lm/W		
Power	-				

PLD 6250

MIMO

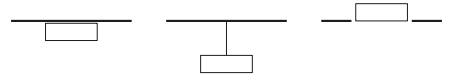

Product	
Code	PLD 6250
Name	MIMO
Categories	PROFIL
Subcategory	Linear
	Decorative
Type	Pendant
	Ceiling lamp
	Trimless
Length	< 5 M
Finishing	RAL on request

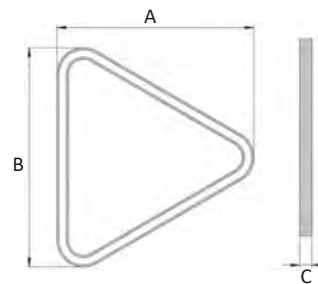

Product Specifications		General Information		Lamp Specifications	
Product Code	PLD 6250	Suspension System	3 wire set	Lamp Type	LED
Body	Extruded Aluminum	Protection	IP40	LED Chip	Samsung
Number of light source	2	Installation	Indoor	Luminous Flux	110 lm/W
Light source color	2700 K → 6000 K	Mounting	Surface mounted/ Pendant	Power	4 W-20 W/m
Cap-Base	22 cm	Trimless	On request	Colour Temperature	2700 K → 6000 K
Light source replacable	Yes	Warranty Period	2 years	Length	2.5 cm → 50 cm
Luminaire light beam	120°			Width	0.8 cm

PLD 6250

MIMO

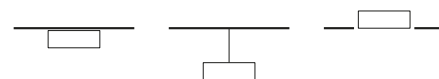

Physical Specifications		Physical Specifications		Options	
Structure	Extruded Aluminum	Finishing	Aluminum anodized/RAL	Length	On request
Reflector	N/A	Weight	-	Finish	RAL on request
Optical Cover	Opal Plexiglass	Body	Extruded Aluminum	Dimmable	On request
Fixation material	Aluminum/Stainless Steel	Diffuser	Opal Plexiglass	Trimless	On request
A	72cm - 102cm - 132cm	UV Protection	Yes	Colour Temperature	2700K -> 6000K
B	72cm - 102cm - 132cm			IP Rate	IP44
C	8.5cm				
Electrical Specifications		Performance		Remarks	
Input Voltage	220-240V	Power	40W - 60W - 70W	Customized length	
Input Frequency	50-60 hz	Luminous Flux	4000 lm - 6000 lm - 7000lm	Angular shapes	
Dimmable	On request	Luminous flux tolerance	10%	RGB version	
Output	24V	Colour Temperature	2700 K -> 6000 K		
IP Rate	IP20-IP67	Colour Rendering Index	≥80		
Power Factor	-	LED Luminaire Efficacy	100 lm/W		
Power	-				

PLD 6300

MORO

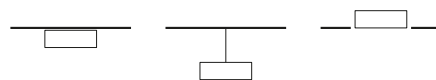

Product	
Code	PLD 6300
Name	MORO
Categories	PROFIL
Subcategory	Linear
	Decorative
Type	Pendant
	Ceiling lamp
	Trimless
Length	< 5 M
Finishing	RAL on request

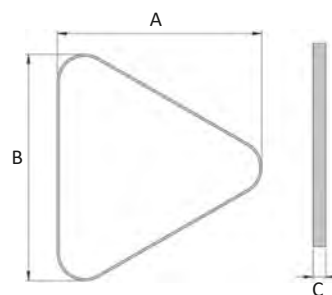

Product Specifications		General Information		Lamp Specifications	
Product Code	PLD 6300	Suspension System	3 wire set	Lamp Type	LED
Body	Extruded Aluminum	Protection	IP40	LED Chip	Samsung
Number of light source	1	Installation	Indoor	Luminous Flux	110 lm/W
Light source color	2700 K → 6000 K	Mounting	Surface mounted/ Pendant	Power	4 W-20 W/m
Cap-Base	22 cm	Trimless	On request	Colour Temperature	2700 K → 6000 K
Light source replacable	Yes	Warranty Period	2 years	Length	2.5 cm → 50 cm
Luminaire light beam	120°			Width	0.8 cm

PLD 6300

MORO

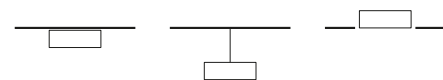

Physical Specifications		Physical Specifications		Options	
Structure	Extruded Aluminum	Finishing	Aluminum anodized/RAL	Length	On request
Reflector	N/A	Weight	-	Finish	RAL on request
Optical Cover	Opal Plexiglass	Body	Extruded Aluminum	Dimmable	On request
Fixation material	Aluminum/Stainless Steel	Diffuser	Opal Plexiglass	Trimless	On request
A	85cm -115cm	UV Protection	Yes	Colour Temperature	2700K -> 6000K
B	85cm - 115cm			IP Rate	IP44
C	8.5cm				
Electrical Specifications		Performance		Remarks	
Input Voltage	220-240V	Power	85W - 105W	Customized length	
Input Frequency	50-60 hz	Luminous Flux	8500 lm - 10500 lm	Angular shapes	
Dimmable	On request	Luminous flux tolerance	10%	RGB version	
Output	24V	Colour Temperature	2700 K -> 6000 K		
IP Rate	IP20-IP67	Colour Rendering Index	≥80		
Power Factor	-	LED Luminaire Efficacy	100 lm/W		
Power	-				

PLD 6350

AVATAR

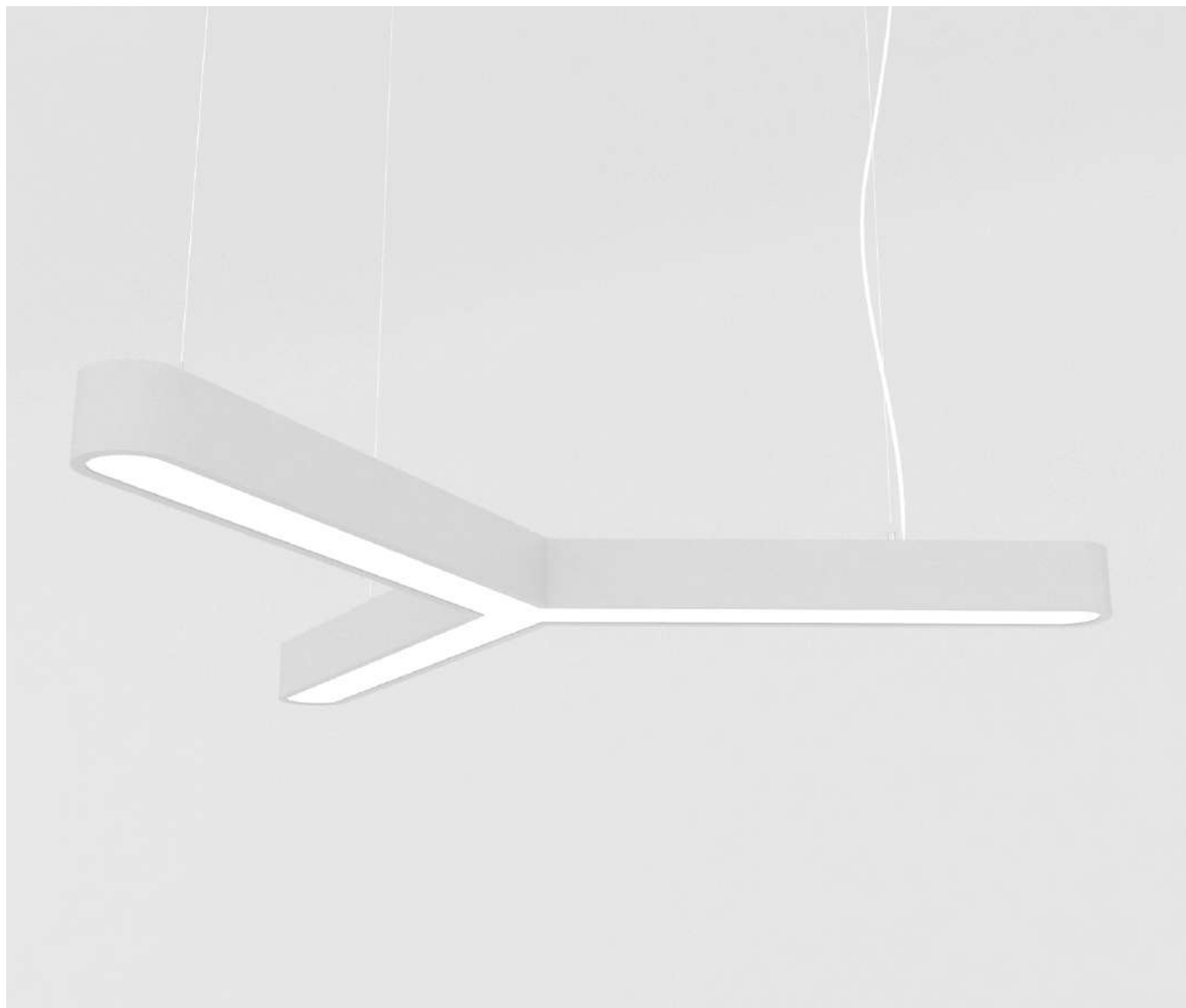
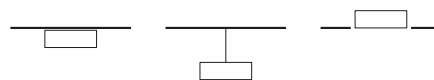

Product	
Code	PLD 6350
Name	AVATAR
Categories	PROFIL
Subcategory	Linear
	Decorative
Type	Pendant
	Ceiling lamp
	Trimless
Length	< 5 M
Finishing	RAL on request

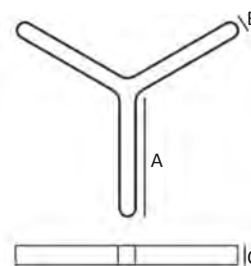

Product Specifications		General Information		Lamp Specifications	
Product Code	PLD 6350	Suspension System	3 wire set	Lamp Type	LED
Body	Extruded Aluminum	Protection	IP40	LED Chip	Samsung
Number of light source	2	Installation	Indoor	Luminous Flux	110 lm/W
Light source color	2700 K -> 6000 K	Mounting	Surface mounted/ Pendant	Power	4 W-20 W/m
Cap-Base	22 cm	Trimless	On request	Colour Temperature	2700 K -> 6000 K
Light source replacable	Yes	Warranty Period	2 years	Length	2.5 cm -> 50 cm
Luminaire light beam	120°			Width	0.8 cm

PLD 6350

AVATAR

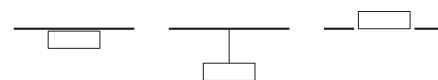

Physical Specifications		Physical Specifications		Options	
Structure	Extruded Aluminum	Finishing	Aluminum anodized/RAL	Length	On request
Reflector	N/A	Weight	-	Finish	RAL on request
Optical Cover	Opal Plexiglass	Body	Extruded Aluminum	Dimmable	On request
Fixation material	Aluminum/Stainless Steel	Diffuser	Opal Plexiglass	Trimless	On request
A	3x50cm	UV Protection	Yes	Colour Temperature	2700K -> 6000K
B	8cm			IP Rate	IP44
C	8.5cm				
Electrical Specifications		Performance		Remarks	
Input Voltage	220-240V	Power	30W	Customized length	
Input Frequency	50-60 hz	Luminous Flux	3000 lm	Angular shapes	
Dimmable	On request	Luminous flux tolerance	10%	RGB version	
Output	24V	Colour Temperature	2700 K -> 6000 K		
IP Rate	IP20-IP67	Colour Rendering Index	≥80		
Power Factor	-	LED Luminaire Efficacy	100 lm/W		
Power	-				

PLD 6400

PENA

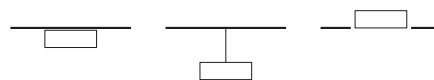

Product	
Code	PLD 6400
Name	PENA
Categories	PROFIL
Subcategory	Linear
	Decorative
Type	Pendant
	Ceiling lamp
	Trimless
Length	< 5 M
Finishing	RAL on request

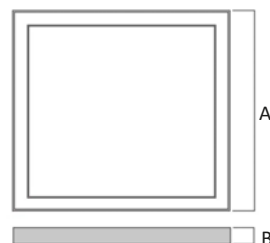

Product Specifications		General Information		Lamp Specifications	
Product Code	PLD 6400	Suspension System	4 wire set	Lamp Type	LED
Body	Extruded Aluminum	Protection	IP40	LED Chip	Samsung
Number of light source	2	Installation	Indoor	Luminous Flux	110 lm/W
Light source color	2700 K → 6000 K	Mounting	Surface mounted/ Pendant	Power	4 W-20 W/m
Cap-Base	22 cm	Trimless	On request	Colour Temperature	2700 K → 6000 K
Light source replacable	Yes	Warranty Period	2 years	Length	2.5 cm → 50 cm
Luminaire light beam	120°			Width	0.8 cm

PLD 6400

PENA

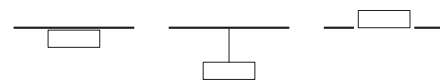

Physical Specifications		Physical Specifications		Options	
Structure	Extruded Aluminum	Finishing	Aluminum anodized/RAL	Length	On request
Reflector	N/A	Weight	-	Finish	RAL on request
Optical Cover	Opal Plexiglass	Body	Extruded Aluminum	Dimmable	On request
Fixation material	Aluminum/Stainless Steel	Diffuser	Opal Plexiglass	Trimless	On request
A	100cm	UV Protection	Yes	Colour Temperature	2700K → 6000K
B	8.5m			IP Rate	IP44

Electrical Specifications		Performance		Remarks	
Input Voltage	220-240V	Power	80W	Customized length	
Input Frequency	50-60 hz	Luminous Flux	8000lm	Angular shapes	
Dimmable	On request	Luminous flux tolerance	10%	RGB version	
Output	24V	Colour Temperature	2700 K → 6000 K		
IP Rate	IP20-IP67	Colour Rendering Index	≥80		
Power Factor	-	LED Luminaire Efficacy	100 lm/W		
Power	-				

PLD 6450

HALO

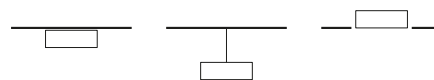

Product	
Code	PLD 6450
Name	HALO
Categories	PROFIL
Subcategory	Linear
	Decorative
Type	Pendant
	Ceiling lamp
	Trimless
Length	< 5 M
Finishing	RAL on request

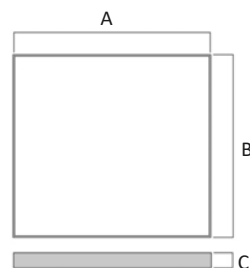

Product Specifications		General Information		Lamp Specifications	
Product Code	PLD 6450	Suspension System	4 wire set	Lamp Type	LED
Body	Extruded Aluminum	Protection	IP40	LED Chip	Samsung
Number of light source	1	Installation	Indoor	Luminous Flux	110 lm/W
Light source color	2700 K → 6000 K	Mounting	Surface mounted/ Pendant	Power	4 W-20 W/m
Cap-Base	22 cm	Trimless	On request	Colour Temperature	2700 K → 6000 K
Light source replacable	Yes	Warranty Period	2 years	Length	2.5 cm → 50 cm
Luminaire light beam	120°			Width	0.8 cm

PLD 6450

HALO

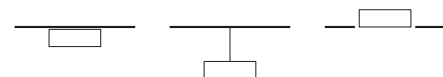

Physical Specifications		Physical Specifications		Options	
Structure	Extruded Aluminum	Finishing	Aluminum anodized/RAL	Length	On request
Reflector	N/A	Weight	-	Finish	RAL on request
Optical Cover	Opal Plexiglass	Body	Extruded Aluminum	Dimmable	On request
Fixation material	Aluminum/Stainless Steel	Diffuser	Opal Plexiglass	Trimless	On request
A	60cm - 90cm - 120cm	UV Protection	Yes	Colour Temperature	2700K -> 6000K
B	60cm - 90cm - 120cm			IP Rate	IP44
C	8.5cm				
Electrical Specifications		Performance		Remarks	
Input Voltage	220-240V	Power	45W - 100W - 150W	Customized length	
Input Frequency	50-60 hz	Luminous Flux	4500 lm - 10000 lm - 15000lm	Angular shapes	
Dimmable	On request	Luminous flux tolerance	10%	RGB version	
Output	24V	Colour Temperature	2700 K -> 6000 K		
IP Rate	IP20-IP67	Colour Rendering Index	≥80		
Power Factor	-	LED Luminaire Efficacy	100 lm/W		
Power	-				

PLD 6600

HEXAL

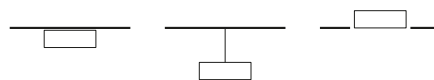

Product	
Code	PLD 6600
Name	HEXAL
Categories	PROFIL
Subcategory	Linear
	Decorative
Type	Pendant
	Ceiling lamp
	Trimless
Length	< 5 M
Finishing	RAL on request

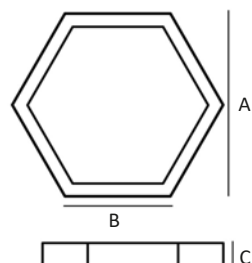

Product Specifications		General Information		Lamp Specifications	
Product Code	PLD 6600	Suspension System	4 wire set	Lamp Type	LED
Body	Extruded Aluminum	Protection	IP40	LED Chip	Samsung
Number of light source	2	Installation	Indoor	Luminous Flux	110 lm/W
Light source color	2700 K → 6000 K	Mounting	Surface mounted/ Pendant	Power	4 W–20 W/m
Cap-Base	22 cm	Trimless	On request	Colour Temperature	2700 K → 6000 K
Light source replacable	Yes	Warranty Period	2 years	Length	2.5 cm → 50 cm
Luminaire light beam	120°			Width	0.8 cm

PLD 6600

HEXAL

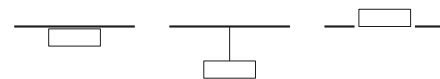

Physical Specifications		Physical Specifications		Options	
Structure	Extruded Aluminum	Finishing	Aluminum anodized/RAL	Length	On request
Reflector	N/A	Weight	-	Finish	RAL on request
Optical Cover	Opal Plexiglass	Body	Extruded Aluminum	Dimmable	On request
Fixation material	Aluminum/Stainless Steel	Diffuser	Opal Plexiglass	Trimless	On request
A	100cm	UV Protection	Yes	Colour Temperature	2700K -> 6000K
B	50cm			IP Rate	IP44
C	8.5cm				
Electrical Specifications		Performance		Remarks	
Input Voltage	220-240V	Power	60W	Customized length	
Input Frequency	50-60 hz	Luminous Flux	6000lm	Angular shapes	
Dimmable	On request	Luminous flux tolerance	10%	RGB version	
Output	24V	Colour Temperature	2700 K -> 6000 K		
IP Rate	IP20-IP67	Colour Rendering Index	≥80		
Power Factor	-	LED Luminaire Efficacy	100 lm/W		
Power	-				

PLD 6650

VOX

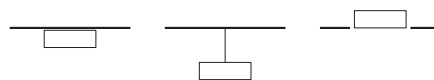

Product	
Code	PLD 6650
Name	VOX
Categories	PROFIL
Subcategory	Linear
	Decorative
Type	Pendant
	Ceiling lamp
	Trimless
Length	< 5 M
Finishing	RAL on request

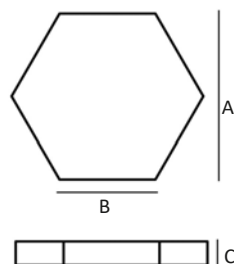

Product Specifications		General Information		Lamp Specifications	
Product Code	PLD 6650	Suspension System	4 wire set	Lamp Type	LED
Body	Extruded Aluminum	Protection	IP40	LED Chip	Samsung
Number of light source	1	Installation	Indoor	Luminous Flux	110 lm/W
Light source color	2700 K → 6000 K	Mounting	Surface mounted/ Pendant	Power	4 W–20 W/m
Cap-Base	22 cm	Trimless	On request	Colour Temperature	2700 K → 6000 K
Light source replacable	Yes	Warranty Period	2 years	Length	2.5 cm → 50 cm
Luminaire light beam	120°			Width	0.8 cm

PLD 6650

VOX

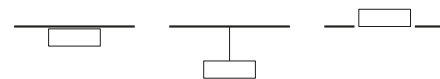

Physical Specifications		Physical Specifications		Options	
Structure	Extruded Aluminum	Finishing	Aluminum anodized/RAL	Length	On request
Reflector	N/A	Weight	-	Finish	RAL on request
Optical Cover	Opal Plexiglass	Body	Extruded Aluminum	Dimmable	On request
Fixation material	Aluminum/Stainless Steel	Diffuser	Opal Plexiglass	Trimless	On request
A	82cm	UV Protection	Yes	Colour Temperature	2700K -> 6000K
B	41cm			IP Rate	IP44
C	8.5cm				

Electrical Specifications		Performance		Remarks	
Input Voltage	220-240V	Power	75W	Customized length	
Input Frequency	50-60 hz	Luminous Flux	7500lm	Angular shapes	
Dimmable	On request	Luminous flux tolerance	10%	RGB version	
Output	24V	Colour Temperature	2700 K -> 6000 K		
IP Rate	IP20-IP67	Colour Rendering Index	≥80		
Power Factor	-	LED Luminaire Efficacy	100 lm/W		
Power	-				

PLD 7010

PRIME T

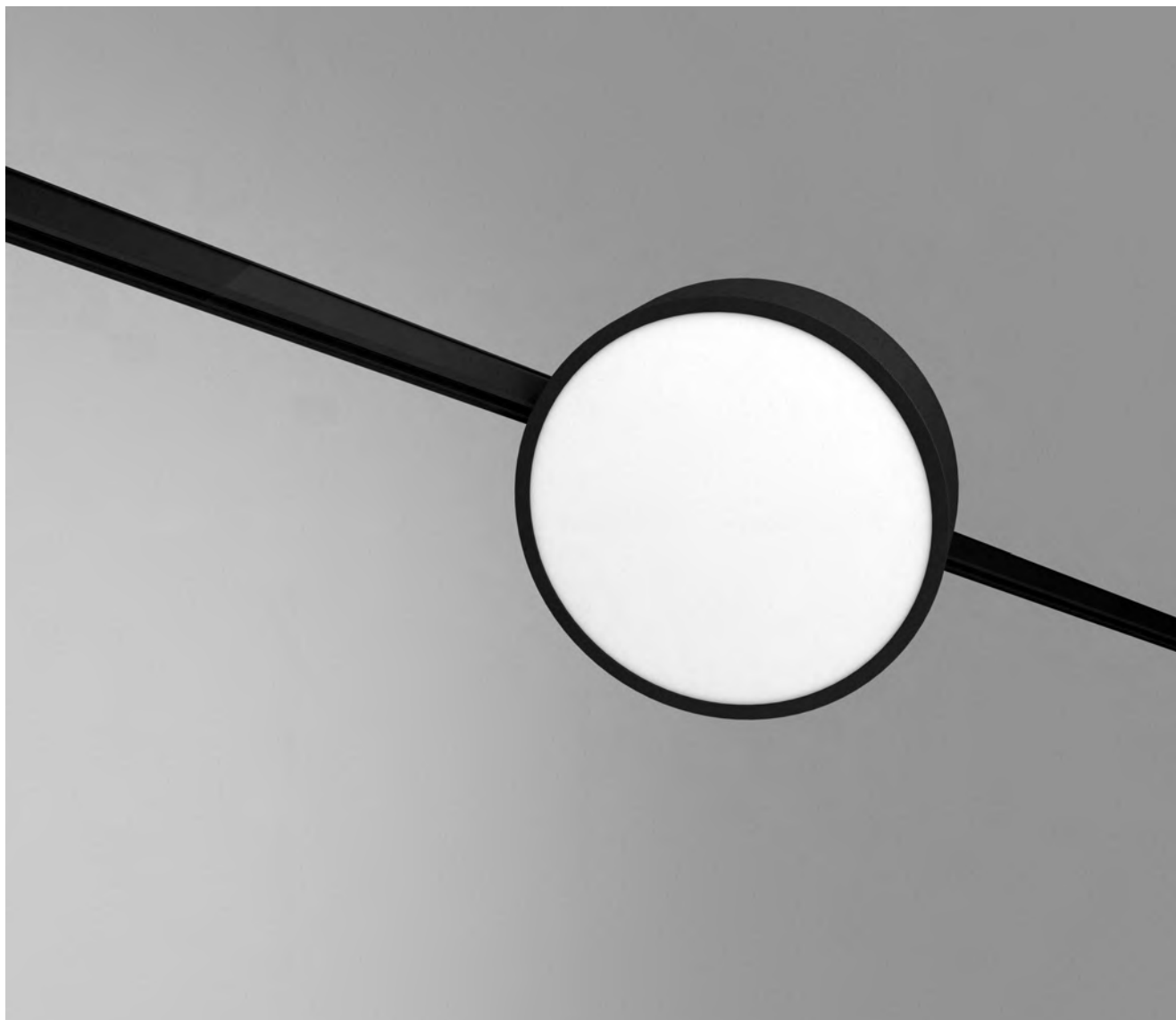
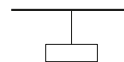

Product	
Code	PLD 7010
Name	PRIME T
Categories	General
Subcategory	Modern
	Decorative
Type	Ceiling lamp
Finishing	RAL on request

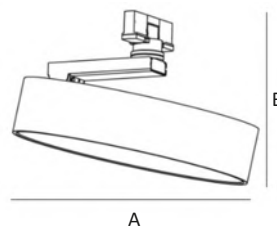

Product Specifications		General Information		Lamp Specifications & Dimensions	
Product Code	PLD 7010	Suspension System	N/A	Lamp Holder	LED
Body	Aluminum	Protection	IP40	Type	Samsung
Number of light source	1	Installation	Indoor	Luminous Flux	100 lm/W
Light source color	2700 K -> 6000 K	Mounting	3 phase track	Power	20W
Cap-Base	N/A	Warranty Period	2 years	Colour Temperature	2700 K -> 6000 K
Light source replacable	Yes			A	30cm
Luminaire light beam	180°			B	15cm
				Custom Dimensions	On request

PLD 7020

PRIME R



Product	
Code	PLD.7020
Name	PRIME R
Categories	General
Subcategory	Modern
	Decorative
Type	Pendant
Finishing	RAL on request

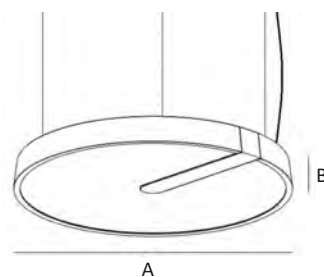

Product Specifications		General Information		Lamp Specifications & Dimensions	
Product Code	PLD 7020	Suspension System	3 wire set	Lamp Holder	LED
Body	Aluminum	Protection	IP40	Type	Samsung
Number of light source	1	Installation	Indoor	Luminous Flux	100 lm/W
Light source color	2700 K -> 6000 K	Mounting	Pendant	Power	40W - 60W - 90W
Cap-Base	N/A	Trimless	On request	Colour Temperature	2700 K -> 6000 K
Light source replacable	Yes	Warranty Period	2 years	A	46cm - 66cm - 96cm
Luminaire light beam	180°			B	8.5cm
				Custom Dimensions	On request

PLD 7030

O₂

Product	
Code	PLD.7030
Name	O ₂
Categories	General
Subcategory	Modern
	Decorative
Type	Pendant
Finishing	RAL on request



Product Specifications		General Information		Lamp Specifications & Dimensions	
Product Code	PLD 7030	Suspension System	3 wire set	Lamp Holder	LED
Body	Aluminum	Protection	IP40	Type	Samsung
Number of light source	1	Installation	Indoor	Luminous Flux	100 lm/W
Light source color	2700 K -> 6000 K	Mounting	Pendant	Power	75W
Cap-Base	N/A	Trimless	On request	Colour Temperature	2700 K -> 6000 K
Light source replacable	Yes	Warranty Period	2 years	A	120cm
Luminaire light beam	180°			B	150cm
				Custom Dimensions	On request

PLD 7040

IN-OUT



Product	
Code	PLD 7040
Name	IN-OUT
Categories	General
Subcategory	Modern
	Decorative
Type	Pendant
Finishing	RAL on request

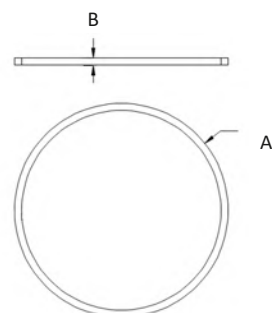

Product Specifications		General Information		Lamp Specifications & Dimensions	
Product Code	PLD 7040	Suspension System	3 wire set	Lamp Holder	LED
Body	Aluminum	Protection	IP40	Type	Samsung
Number of light source	2	Installation	Indoor	Luminous Flux	100 lm/W
Light source color	2700 K → 6000 K	Mounting	Pendant	Power	60W
Cap-Base	N/A	Trimless	N/A	Colour Temperature	2700 K → 6000 K
Light source replacable	Yes	Warranty Period	2 years	A	100cm
Luminaire light beam	180°			B	3cm
				Custom Dimensions	On request

PLD 7050

RINGS

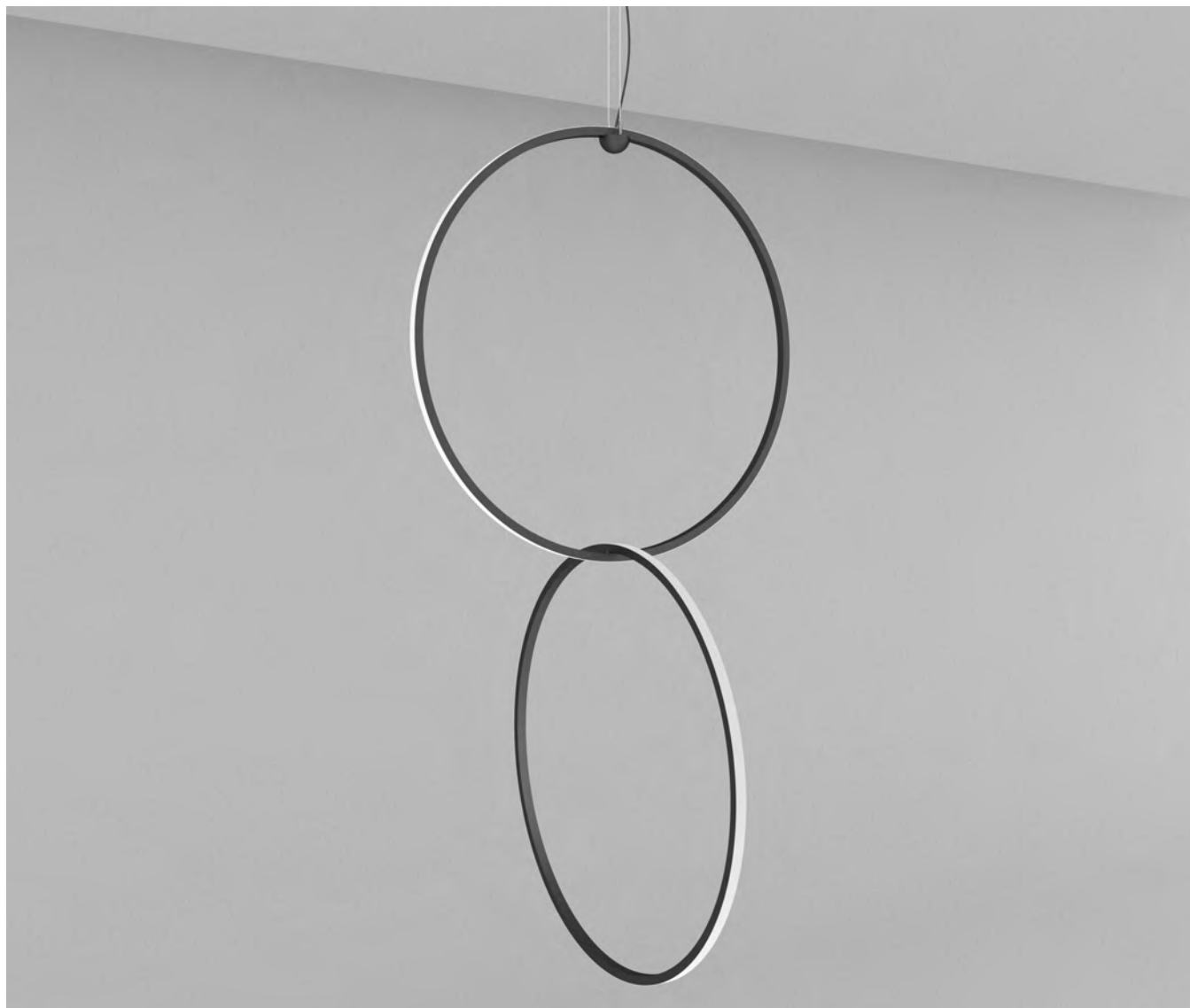

Product	
Code	PLD 7050
Name	RINGS
Categories	General
Subcategory	Modern
	Decorative
Type	Pendant
Finishing	RAL on request



Product Specifications		General Information		Lamp Specifications & Dimensions	
Product Code	PLD 7050	Suspension System	2 wire set	Lamp Holder	LED
Body	Aluminum	Protection	IP40	Type	Samsung
Number of light source	1	Installation	Indoor	Luminous Flux	100 lm/W
Light source color	2700 K → 6000 K	Mounting	Pendant	Power	36W
Cap-Base	N/A	Trimless	N/A	Colour Temperature	2700 K → 6000 K
Light source replacable	Yes	Warranty Period	2 years	A	70cm
Luminaire light beam	180°			B	120cm
				Custom Dimensions	On request



PLD 7060

ABOVE



Product	
Code	PLD 7060
Name	ABOVE
Categories	General
Subcategory	Modern
	Decorative
Type	Floor Lamp
Finishing	RAL on request

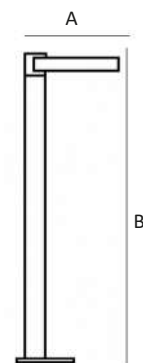

Product Specifications		General Information		Lamp Specifications & Dimensions	
Product Code	PLD 7060	Suspension System	N/A	Lamp Holder	LED
Body	Aluminum	Protection	IP40	Type	Samsung
Number of light source	1	Installation	Indoor	Luminous Flux	100 lm/W
Light source color	2700 K → 6000 K	Mounting	Stand alone	Power	35W
Cap-Base	N/A	Warranty Period	2 years	Colour Temperature	2700 K → 6000 K
Light source replacable	Yes			A	60cm
Luminaire light beam	180°			B	170cm
				Custom Dimensions	On request



PLD 7070

ROOT



Product	
Code	PLD 7070
Name	ROOT
Categories	General
Subcategory	Modern
	Decorative
Type	Floor Lamp
Finishing	RAL on request



Product Specifications		General Information		Lamp Specifications & Dimensions	
Product Code	PLD 7070	Suspension System	N/A	Lamp Holder	LED
Body	Aluminum	Protection	IP40	Type	Samsung
Number of light source	1	Installation	Indoor	Luminous Flux	100 lm/W
Light source color	2700 K → 6000 K	Mounting	Stand alone	Power	40W
Cap-Base	N/A	Warranty Period	2 years	Colour Temperature	2700 K → 6000 K
Light source replacable	Yes			A	80x30cm
Luminaire light beam	180°			B	190cm
				Custom Dimensions	On request



PLD 7080

BALANCE



Product	
Code	PLD 7080
Name	BALANCE
Categories	General
Subcategory	Modern
	Decorative
Type	Floor Lamp
Finishing	RAL on request

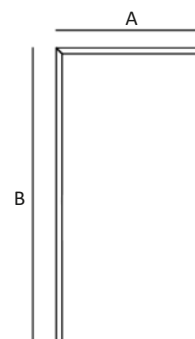

Product Specifications		General Information		Lamp Specifications & Dimensions	
Product Code	PLD 7080	Suspension System	N/A	Lamp Holder	LED
Body	Aluminum	Protection	IP40	Type	Samsung
Number of light source	1	Installation	Indoor	Luminous Flux	100 lm/W
Light source color	2700 K → 6000 K	Mounting	Stand alone	Power	30W
Cap-Base	N/A	Warranty Period	2 years	Colour Temperature	2700 K → 6000 K
Light source replaceable	Yes			A	100cm
Luminaire light beam	180°			B	180cm
				Custom Dimensions	On request

MLA 001

PINO V

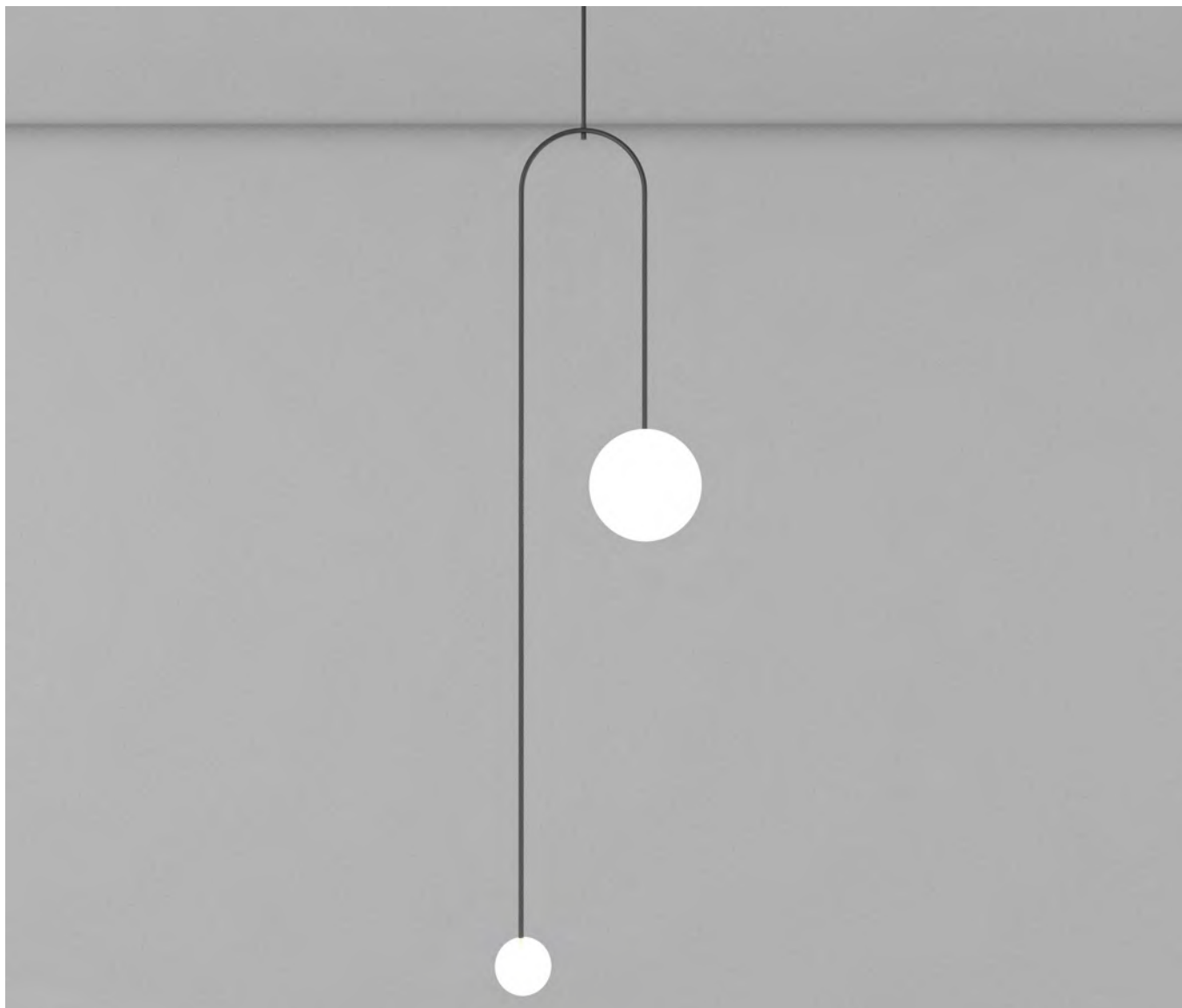

Product	
Code	MLA 001
Name	PINO V
Categories	General
Subcategory	Modern
	Decorative
Type	Pendant
Finishing	On request



A

Product Specifications	General Information		Lamp Specifications & Dimensions		
Product Code	MLA 001	Suspension System	1 wire set	Lamp Holder	G9 + E14
Body	Metal	Protection	IP40	Type	LED
Number of light source	2	Installation	Indoor	Luminous Flux	80 lm/W
Light source color	2700 K -> 6000 K	Mounrting	Pendant	Power	3W + 6W
Cap-Base	6cm	Warranty Period	2 years	Colour Temperature	2700 K -> 6000 K
Light source replacable	Yes			A	40cm
Luminaire light beam	180°			B	120cm
				Custom Dimensions	On request

MLA 002

PINO H

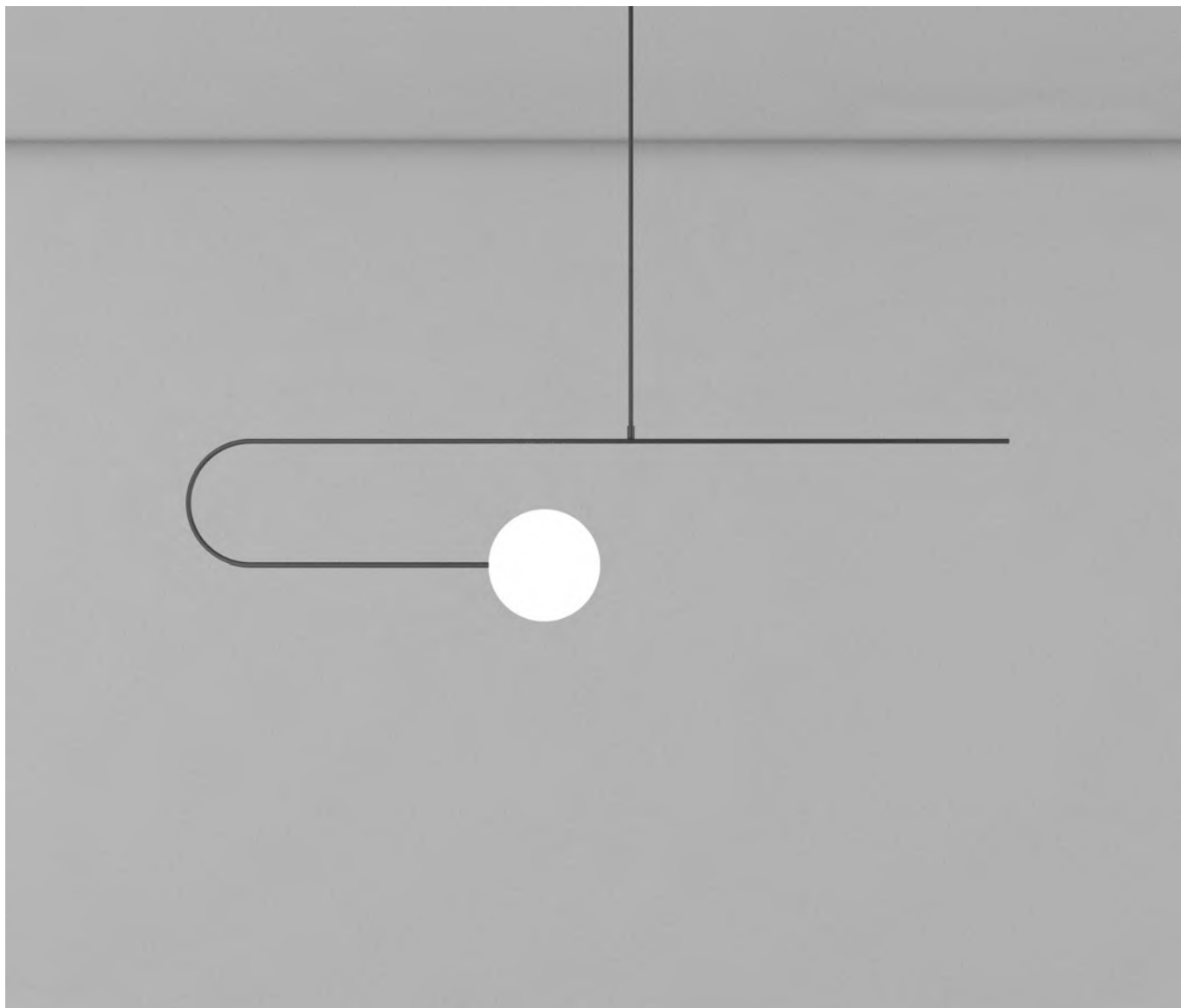

Product	
Code	MLA 002
Name	PINO H
Categories	General
Subcategory	Modern
	Decorative
Type	Pendant
Finishing	RAL on request

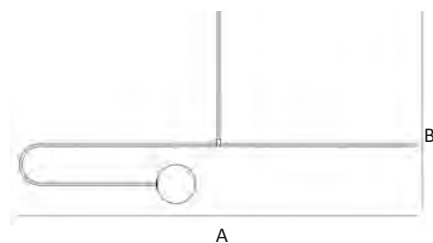

Product Specifications		General Information		Lamp Specifications & Dimensions	
Product Code	MLA 002	Suspension System	1 wire set	Lamp Holder	E14
Body	Metal	Protection	IP40	Type	LED
Number of light source	2	Installation	Indoor	Luminous Flux	80 lm/W
Light source color	2700 K → 6000 K	Mounting	Pendant	Power	6W
Cap-Base	N/A	Warranty Period	2 years	Colour Temperature	2700 K → 6000 K
Light source replaceable	Yes			A	100cm
Luminaire light beam	180°			B	150cm
				Custom Dimensions	On request

MLA 003

PINO S

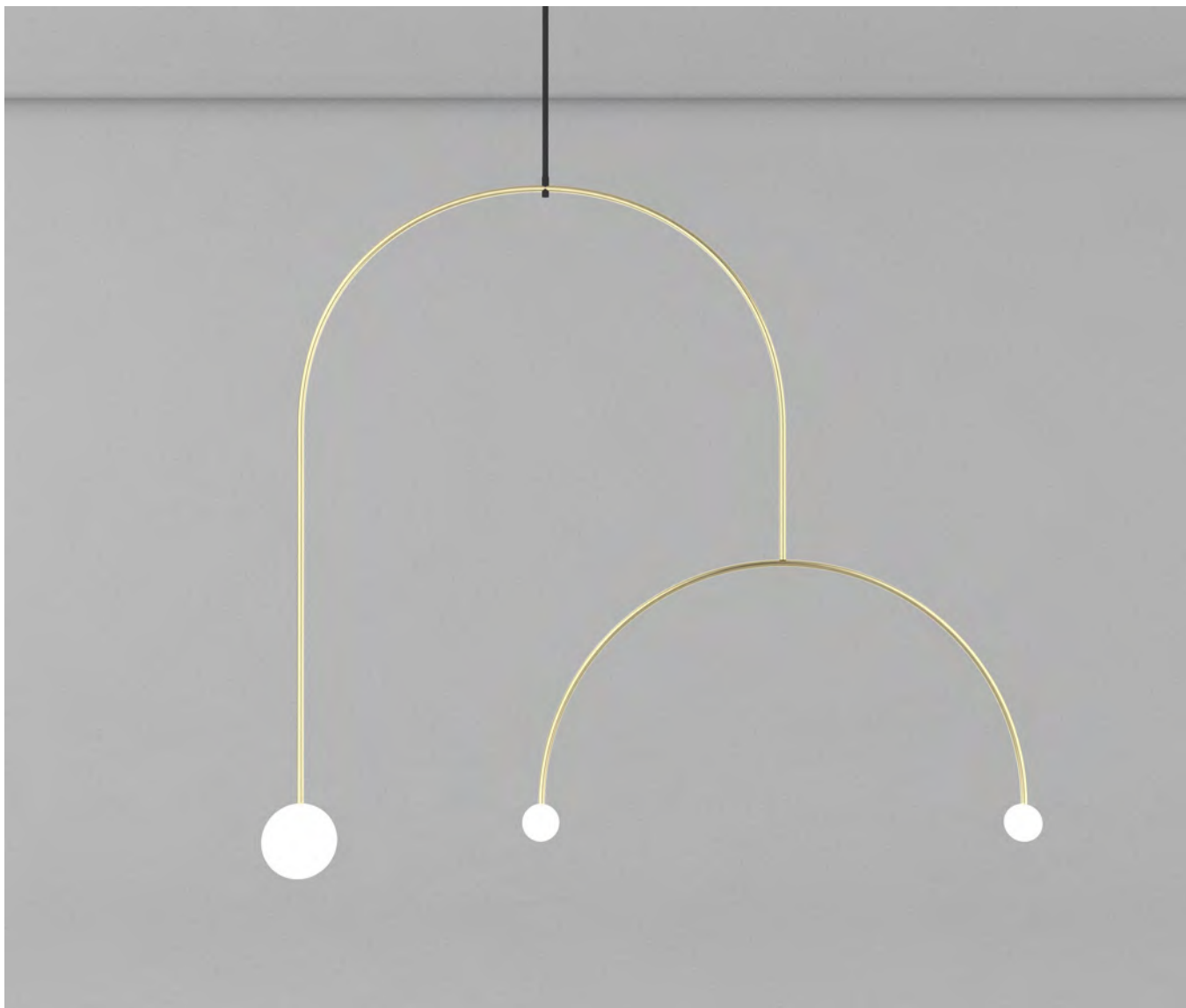

Product	
Code	MLA 003
Name	PINO S
Categories	General
Subcategory	Modern
	Decorative
Type	Pendant
Finishing	On request

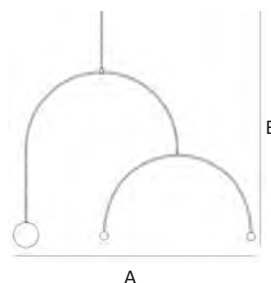

Product Specifications		General Information		Lamp Specifications & Dimensions	
Product Code	MLA 003	Suspension System	1 wire set	Lamp Holder	G9 + E14
Body	Metal	Protection	IP40	Type	LED
Number of light source	3	Installation	Indoor	Luminous Flux	80 lm/W
Light source color	2700 K → 6000 K	Mounrting	Pendant	Power	3W + 6W
Cap-Base	6cm	Warranty Period	2 years	Colour Temperature	2700 K → 6000 K
Light source replacable	Yes			A	130cm
Luminaire light beam	180°			B	150cm
				Custom Dimensions	On request

MLA 004

BULBS

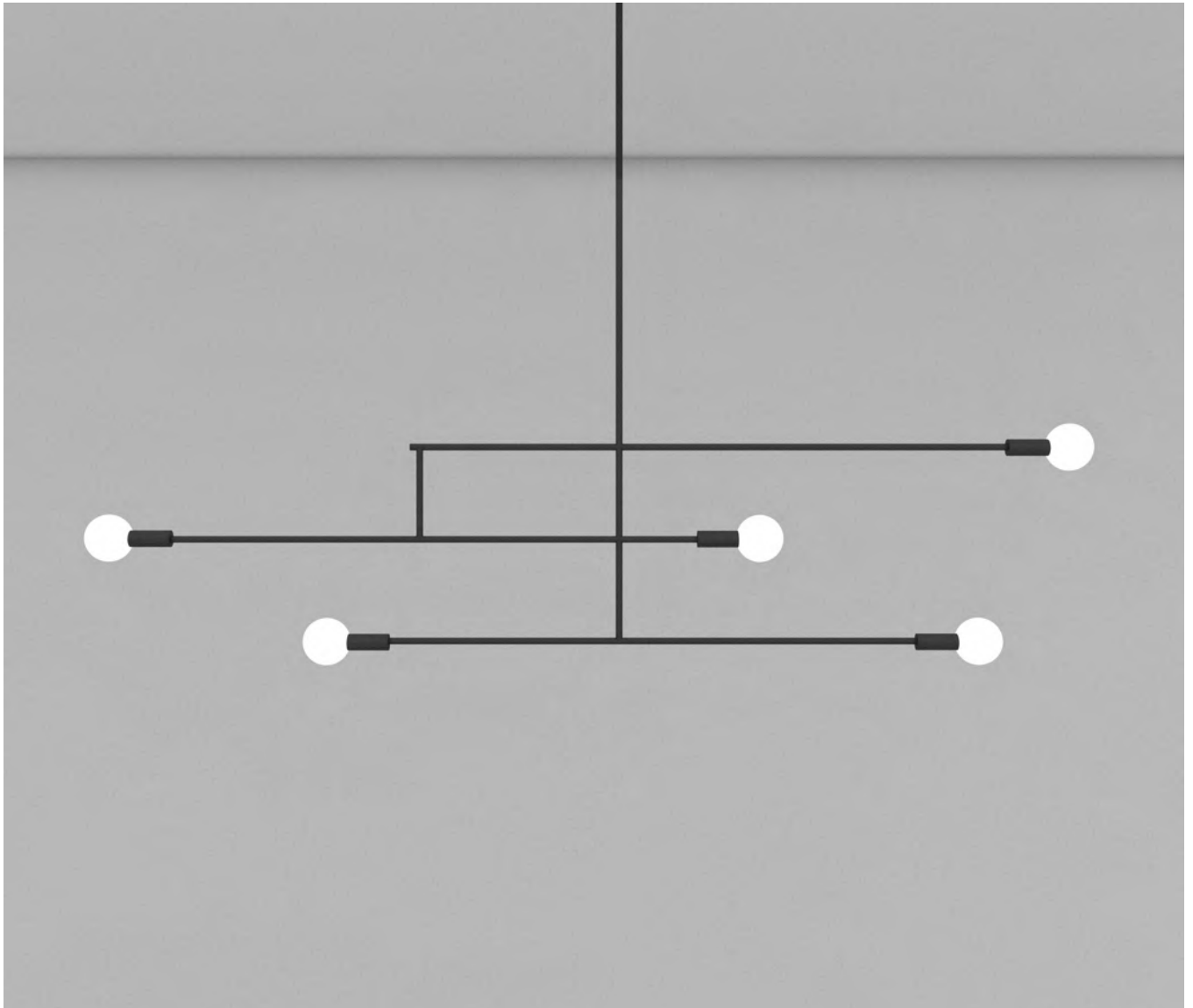

Product	
Code	MLA 004
Name	BULBS
Categories	General
Subcategory	Modern
	Decorative
Type	Pendant
Finishing	RAL on request

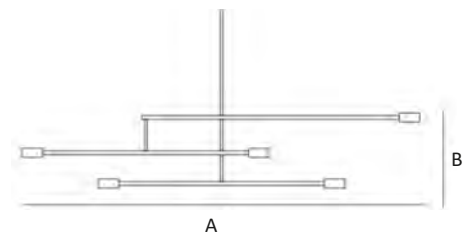

Product Specifications		General Information		Lamp Specifications & Dimensions	
Product Code	MLA 004	Suspension System	1 wire set	Lamp Holder	E14
Body	Metal	Protection	IP40	Type	LED
Number of light source	5	Installation	Indoor	Luminous Flux	80 lm/W
Light source color	2700 K → 6000 K	Mounting	Pendant	Power	5W
Cap-Base	N/A	Warranty Period	2 years	Colour Temperature	2700 K → 6000 K
Light source replacable	Yes			A	120cm
Luminaire light beam	180°			B	60cm
				Custom Dimensions	On request

MLA 005

ADD ON S



Product	
Code	MLA 005
Name	ADD ON S
Categories	General
Subcategory	Modern
	Decorative
Type	Pendant
Finishing	On request

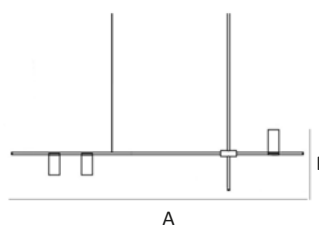

Product Specifications		General Information		Lamp Specifications & Dimensions	
Product Code	MLA 005	Suspension System	1 wire set	Lamp Holder	GU10
Body	Metal	Protection	IP40	Type	LED
Number of light source	3	Installation	Indoor	Luminous Flux	80 lm/W
Light source color	2700 K → 6000 K	Mounrting	Pendant	Power	3X5W
Cap-Base	6cm	Warranty Period	2 years	Colour Temperature	2700 K → 6000 K
Light source replacable	Yes			A	120cm
Luminaire light beam	180°			B	30cm
				Custom Dimensions	On request

MLA 006

ADD ON B



Product	
Code	MLA 006
Name	ADD ON B
Categories	General
Subcategory	Modern
Type	Decorative
Type	Pendant
Finishing	RAL on request

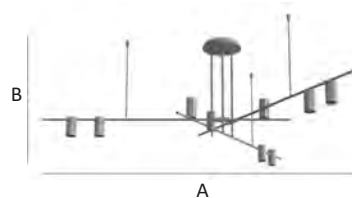

Product Specifications		General Information		Lamp Specifications & Dimensions	
Product Code	MLA 006	Suspension System	1 wire set	Lamp Holder	GU10
Body	Metal	Protection	IP40	Type	LED
Number of light source	9	Installation	Indoor	Luminous Flux	80 lm/W
Light source color	2700 K -> 6000 K	Mounting	Pendant	Power	9X5W
Cap-Base	N/A	Warranty Period	2 years	Colour Temperature	2700 K -> 6000 K
Light source replacable	Yes			A	150cm
Luminaire light beam	180°			B	150cm
				Custom Dimensions	On request

MLA 007

FIT IN H



Product	
Code	MLA 007
Name	FIT IN H
Categories	General
Subcategory	Modern
	Decorative
Type	Pendant
Finishing	On request

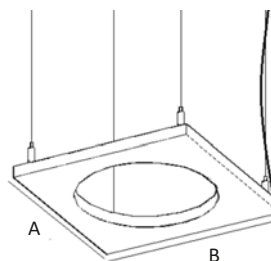

Product Specifications		General Information		Lamp Specifications & Dimensions	
Product Code	MLA 007	Suspension System	4 wire set	Lamp Holder	LED
Body	Aluminum + Wood	Protection	IP40	Type	SAMSUNG
Number of light source	1	Installation	Indoor	Luminous Flux	100 lm/W
Light source color	2700 K → 6000 K	Mounting	Pendant	Power	30W
Cap-Base	22cm	Warranty Period	2 years	Colour Temperature	2700 K → 6000 K
Light source replacable	Yes			A	100cm
Luminaire light beam	180°			B	100cm
				Custom Dimensions	On request

MLA 008

FIT IN V

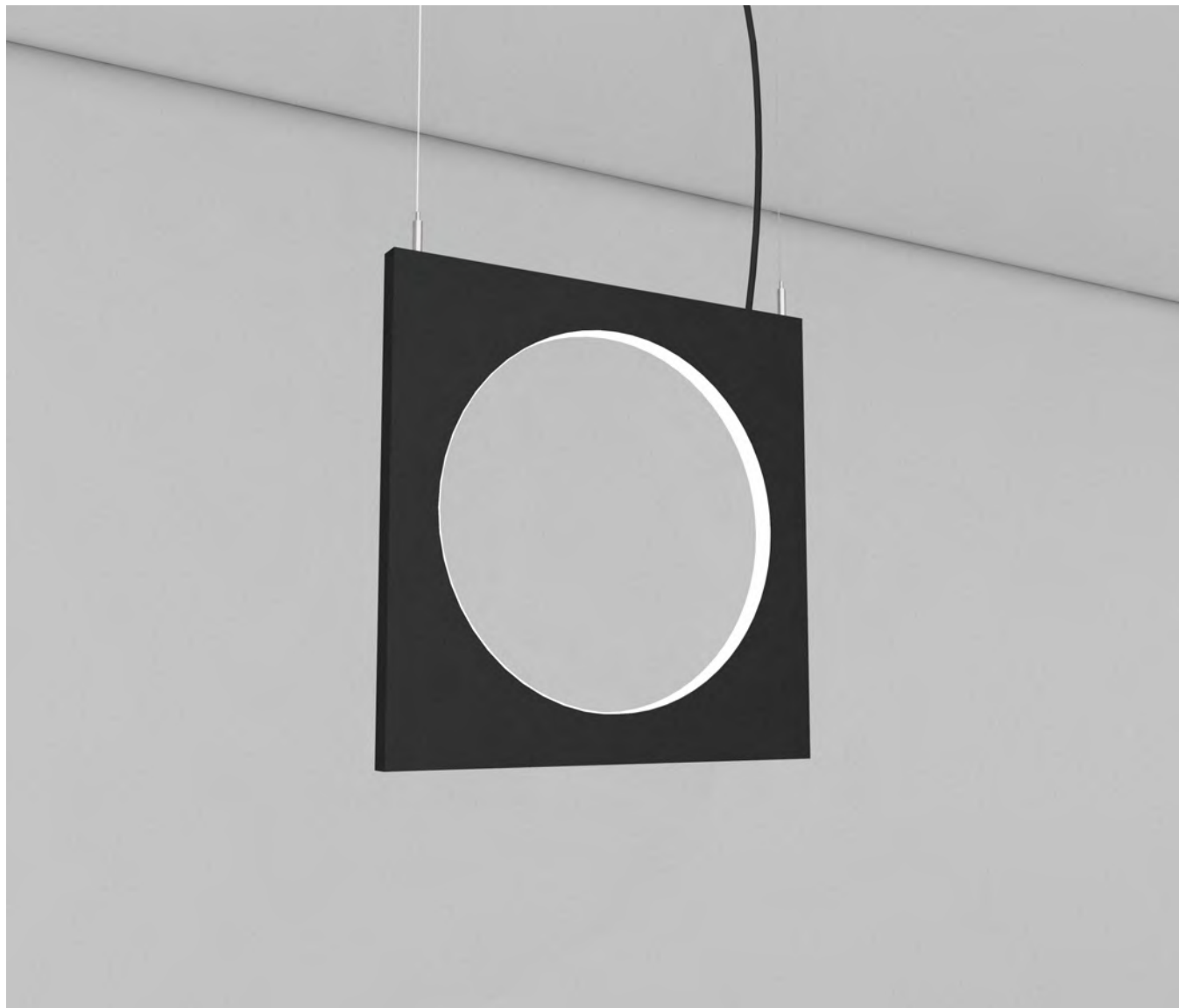

Product	
Code	MLA 008
Name	FITT IN V
Categories	General
Subcategory	Modern
	Decorative
Type	Pendant
Finishing	RAL on request

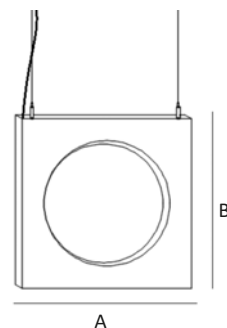

Product Specifications		General Information		Lamp Specifications & Dimensions	
Product Code	MLA 008	Suspension System	2 wire set	Lamp Holder	LED
Body	Aluminum + Wood	Protection	IP40	Type	SAMSUNG
Number of light source	1	Installation	Indoor	Luminous Flux	100 lm/W
Light source color	2700 K -> 6000 K	Mounting	Pendant	Power	30W
Cap-Base	N/A	Warranty Period	2 years	Colour Temperature	2700 K -> 6000 K
Light source replacable	Yes			A	100cm
Luminaire light beam	180°			B	100cm
				Custom Dimensions	On request

MLA 009

LOFT



Product	
Code	MLA 009
Name	LOFT
Categories	General
Subcategory	Modern
	Decorative
Type	Pendant
Finishing	On request



Product Specifications		General Information		Lamp Specifications & Dimensions	
Product Code	MLA 009	Suspension System	1 wire set	Lamp Holder	LED
Body	Aluminum	Protection	IP40	Type	SAMSUNG
Number of light source	1	Installation	Indoor	Luminous Flux	100 lm/W
Light source color	2700 K -> 6000 K	Mourting	Pendant	Power	15W
Cap-Base	22cm	Warranty Period	2 years	Colour Temperature	2700 K -> 6000 K
Light source replacable	Yes			A	20cm
Luminaire light beam	180°			B	150cm
				Custom Dimensions	On request

MLA 010

LOFT SH



Product	
Code	MLA 010
Name	LOFT SH
Categories	General
Subcategory	Modern
	Decorative
Type	Pendant
Finishing	RAL on request

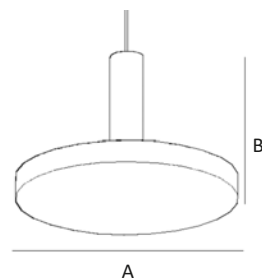

Product Specifications		General Information		Lamp Specifications & Dimensions	
Product Code	MLA 010	Suspension System	1 wire set	Lamp Holder	LED
Body	Aluminum	Protection	IP40	Type	SAMSUNG
Number of light source	1	Installation	Indoor	Luminous Flux	100 lm/W
Light source color	2700 K → 6000 K	Mounting	Pendant	Power	30W
Cap-Base	N/A	Warranty Period	2 years	Colour Temperature	2700 K → 6000 K
Light source replaceable	Yes			A	40cm
Luminaire light beam	180°			B	30cm
				Custom Dimensions	On request

MLA 011

LOFT B



Product	
Code	MLA 011
Name	LOFT B
Categories	General
Subcategory	Modern
	Decorative
Type	Pendant
Finishing	On request

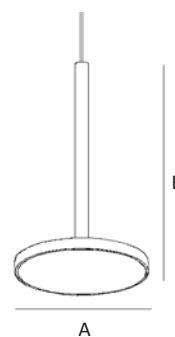

Product Specifications		General Information		Lamp Specifications & Dimensions	
Product Code	MLA 011	Suspension System	1 wire set	Lamp Holder	LED
Body	Aluminum	Protection	IP40	Type	SAMSUNG
Number of light source	1	Installation	Indoor	Luminous Flux	100 lm/W
Light source color	2700 K → 6000 K	Mournting	Pendant	Power	30W
Cap-Base	6cm	Warranty Period	2 years	Colour Temperature	2700 K → 6000 K
Light source replacable	Yes			A	40cm
Luminaire light beam	180°			B	80cm
				Custom Dimensions	On request

MLA 012

DAIA



Product	
Code	MLA 012
Name	DAIA
Categories	General
Subcategory	Modern
	Decorative
Type	Pendant
Finishing	RAL on request

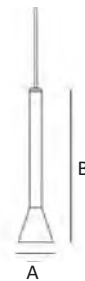

Product Specifications		General Information		Lamp Specifications & Dimensions	
Product Code	MLA 012	Suspension System	1 wire set	Lamp Holder	GU10
Body	Metal	Protection	IP40	Type	LED
Number of light source	1	Installation	Indoor	Luminous Flux	80 lm/W
Light source color	2700 K → 6000 K	Mounting	Pendant	Power	5W
Cap-Base	N/A	Warranty Period	2 years	Colour Temperature	2700 K → 6000 K
Light source replacable	Yes			A	8cm
Luminaire light beam	180°			B	40cm
				Custom Dimensions	On request

MLA 013

PERSIA



Product	
Code	MLA 013
Name	PERSIA
Categories	General
Subcategory	Modern
	Decorative
Type	Pendant
Finishing	On request



Product Specifications		General Information		Lamp Specifications & Dimensions	
Product Code	MLA 013	Suspension System	1 wire set	Lamp Holder	LED
Body	Metal	Protection	IP40	Type	SAMSUNG
Number of light source	1	Installation	Indoor	Luminous Flux	80 lm/W
Light source color	2700 K → 6000 K	Mournting	Pendant	Power	10W
Cap-Base	6cm	Warranty Period	2 years	Colour Temperature	2700 K → 6000 K
Light source replacable	Yes			A	26cm
Luminaire light beam	180°			B	13cm
				Custom Dimensions	On request

MLA 014

CIRCUS



Product	
Code	MLA 014
Name	CIRCUS
Categories	General
Subcategory	Modern
	Decorative
Type	Pendant
Finishing	RAL on request

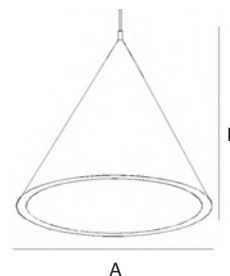

Product Specifications		General Information		Lamp Specifications & Dimensions	
Product Code	MLA 014	Suspension System	1 wire set	Lamp Holder	LED
Body	Metal	Protection	IP40	Type	SAMSUNG
Number of light source	1	Installation	Indoor	Luminous Flux	100 lm/W
Light source color	2700 K → 6000 K	Mounting	Pendant	Power	20W
Cap-Base	N/A	Warranty Period	2 years	Colour Temperature	2700 K → 6000 K
Light source replacable	Yes			A	35cm
Luminaire light beam	180°			B	25cm
				Custom Dimensions	On request

MLA 015

TIP



Product	
Code	MLA 015
Name	TIP
Categories	General
Subcategory	Modern
	Decorative
Type	Pendant
Finishing	On request

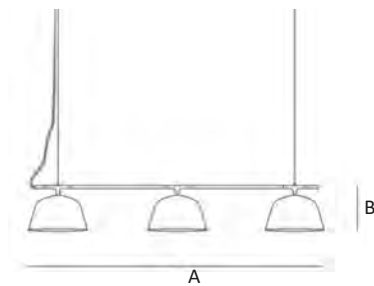

Product Specifications		General Information		Lamp Specifications & Dimensions	
Product Code	MLA 015	Suspension System	2 wire set	Lamp Holder	E27
Body	Metal	Protection	IP40	Type	LED
Number of light source	3	Installation	Indoor	Luminous Flux	80 lm/W
Light source color	2700 K -> 6000 K	Mournting	Pendant	Power	3X10W
Cap-Base	6cm	Warranty Period	2 years	Colour Temperature	2700 K -> 6000 K
Light source replacable	Yes			A	130cm
Luminaire light beam	180°			B	30cm
				Custom Dimensions	On request

MLA 016

TRIBE



Product	
Code	MLA 016
Name	TRIBE
Categories	General
Subcategory	Modern
	Decorative
Type	Pendant
Finishing	RAL on request

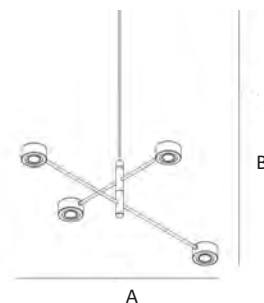

Product Specifications		General Information		Lamp Specifications & Dimensions	
Product Code	MLA 016	Suspension System	1 wire set	Lamp Holder	LED
Body	Metal	Protection	IP40	Type	SAMSUNG
Number of light source	4	Installation	Indoor	Luminous Flux	100 lm/W
Light source color	2700 K → 6000 K	Mounting	Pendant	Power	4X3W
Cap-Base	N/A	Warranty Period	2 years	Colour Temperature	2700 K → 6000 K
Light source replacable	Yes			A	100cm
Luminaire light beam	180°			B	150cm
				Custom Dimensions	On request

MLA 017

CONIC



Product	
Code	MLA 017
Name	CONIC
Categories	General
Subcategory	Modern
	Decorative
Type	Pendant
Finishing	On request

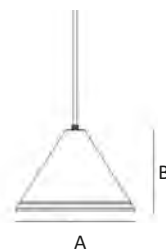

Product Specifications		General Information		Lamp Specifications & Dimensions	
Product Code	MLA 017	Suspension System	1 wire set	Lamp Holder	E27
Body	Metal	Protection	IP40	Type	LED
Number of light source	1	Installation	Indoor	Luminous Flux	80 lm/W
Light source color	2700 K → 6000 K	Mourting	Pendant	Power	10W
Cap-Base	6cm	Warranty Period	2 years	Colour Temperature	2700 K → 6000 K
Light source replacable	Yes			A	30cm
Luminaire light beam	180°			B	20cm
				Custom Dimensions	On request

MLA 018

TRIP



Product	
Code	MLA 018
Name	TRIP
Categories	General
Subcategory	Modern
	Decorative
Type	Pendant
Finishing	RAL on request



Product Specifications		General Information		Lamp Specifications & Dimensions	
Product Code	MLA 018	Suspension System	1 wire set	Lamp Holder	E27
Body	Metal	Protection	IP40	Type	LED
Number of light source	1	Installation	Indoor	Luminous Flux	80 lm/W
Light source color	2700 K → 6000 K	Mounting	Pendant	Power	10W
Cap-Base	N/A	Warranty Period	2 years	Colour Temperature	2700 K → 6000 K
Light source replacable	Yes			A	30cm
Luminaire light beam	180°			B	35cm
				Custom Dimensions	On request

MLA 019

BELLA



Product	
Code	MLA 019
Name	BELLA
Categories	General
Subcategory	Modern
	Decorative
Type	Pendant
Finishing	On request

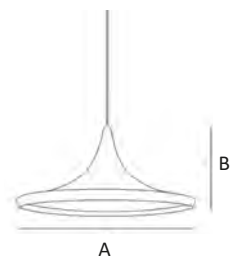

Product Specifications		General Information		Lamp Specifications & Dimensions	
Product Code	MLA 019	Suspension System	1 wire set	Lamp Holder	E27
Body	Metal	Protection	IP40	Type	LED
Number of light source	1	Installation	Indoor	Luminous Flux	80 lm/W
Light source color	2700 K → 6000 K	Mournting	Pendant	Power	10W
Cap-Base	6cm	Warranty Period	2 years	Colour Temperature	2700 K → 6000 K
Light source replacable	Yes			A	40cm
Luminaire light beam	180°			B	20cm
				Custom Dimensions	On request

MLA 020

VOODOO



Product	
Code	MLA 020
Name	VOODOO
Categories	General
Subcategory	Modern
Type	Decorative
Finishing	Pendant
	RAL on request



Product Specifications		General Information		Lamp Specifications & Dimensions	
Product Code	MLA 020	Suspension System	1 wire set	Lamp Holder	E27
Body	Metal	Protection	IP40	Type	LED
Number of light source	1	Installation	Indoor	Luminous Flux	80 lm/W
Light source color	2700 K → 6000 K	Mounting	Pendant	Power	10W
Cap-Base	N/A	Warranty Period	2 years	Colour Temperature	2700 K → 6000 K
Light source replacable	Yes			A	30cm
Luminaire light beam	180°			B	36cm
				Custom Dimensions	On request

MLA 021

TOK



Product	
Code	MLA 021
Name	TOK
Categories	General
Subcategory	Modern
	Decorative
Type	Pendant
Finishing	On request

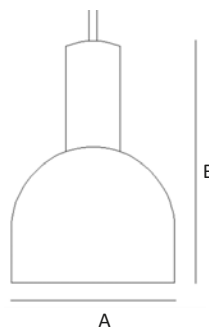

Product Specifications		General Information		Lamp Specifications & Dimensions	
Product Code	MLA 021	Suspension System	1 wire set	Lamp Holder	E27
Body	Metal	Protection	IP40	Type	LED
Number of light source	1	Installation	Indoor	Luminous Flux	80 lm/W
Light source color	2700 K → 6000 K	Mournting	Pendant	Power	10W
Cap-Base	6cm	Warranty Period	2 years	Colour Temperature	2700 K → 6000 K
Light source replacable	Yes			A	30cm
Luminaire light beam	180°			B	35cm
				Custom Dimensions	On request

MLA 022

POT



Product	
Code	MLA 022
Name	POT
Categories	General
Subcategory	Modern
	Decorative
Type	Pendant
Finishing	RAL on request

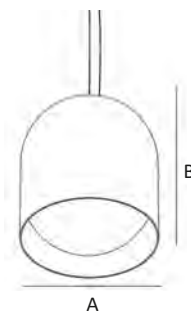

Product Specifications		General Information		Lamp Specifications & Dimensions	
Product Code	MLA 022	Suspension System	1 wire set	Lamp Holder	E27
Body	Metal	Protection	IP40	Type	LED
Number of light source	1	Installation	Indoor	Luminous Flux	80 lm/W
Light source color	2700 K → 6000 K	Mounting	Pendant	Power	10W
Cap-Base	N/A	Warranty Period	2 years	Colour Temperature	2700 K → 6000 K
Light source replaceable	Yes			A	22cm
Luminaire light beam	180°			B	40cm
				Custom Dimensions	On request

MLA 023

DOME

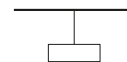

Product	
Code	MLA 023
Name	DOME
Categories	General
Subcategory	Modern
	Decorative
Type	Pendant
Finishing	On request

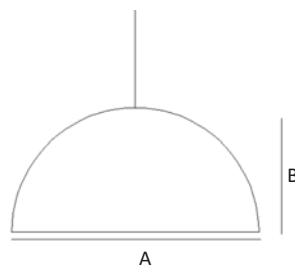

Product Specifications		General Information		Lamp Specifications & Dimensions	
Product Code	MLA 023	Suspension System	1 wire set	Lamp Holder	E27
Body	Metal	Protection	IP40	Type	LED
Number of light source	1	Installation	Indoor	Luminous Flux	80 lm/W
Light source color	2700 K → 6000 K	Mounrtng	Pendant	Power	10W
Cap-Base	6cm	Warranty Period	2 years	Colour Temperature	2700 K → 6000 K
Light source replacable	Yes			A	50cm
Luminaire light beam	180°			B	25cm
				Custom Dimensions	On request

MLA 024

AS



Product	
Code	MLA 024
Name	AS
Categories	General
Subcategory	Modern
	Decorative
Type	Pendant
Finishing	RAL on request

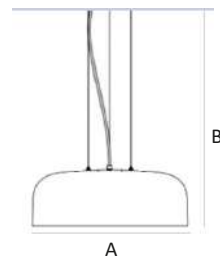

Product Specifications		General Information		Lamp Specifications & Dimensions	
Product Code	MLA 024	Suspension System	1 wire set	Lamp Holder	LED
Body	Metal	Protection	IP40	Type	SAMSUNG
Number of light source	1	Installation	Indoor	Luminous Flux	100 lm/W
Light source color	2700 K → 6000 K	Mounting	Pendant	Power	30W
Cap-Base	N/A	Warranty Period	2 years	Colour Temperature	2700 K → 6000 K
Light source replacable	Yes			A	40cm
Luminaire light beam	180°			B	150cm
				Custom Dimensions	On request

MLA 025

MARS



Product	
Code	MLA 025
Name	MARS
Categories	General
Subcategory	Modern
	Decorative
Type	Pendant
Finishing	On request

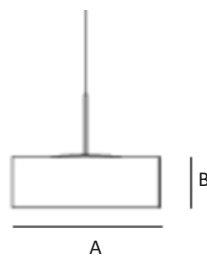

Product Specifications		General Information		Lamp Specifications & Dimensions	
Product Code	MLA 025	Suspension System	1 wire set	Lamp Holder	LED
Body	Metal	Protection	IP40	Type	SAMSUNG
Number of light source	2	Installation	Indoor	Luminous Flux	100 lm/W
Light source color	2700 K → 6000 K	Mounrting	Pendant	Power	25W
Cap-Base	6cm	Warranty Period	2 years	Colour Temperature	2700 K → 6000 K
Light source replacable	Yes			A	35cm
Luminaire light beam	180°			B	15cm
				Custom Dimensions	On request

MLA 026

ARTEMIS



Product	
Code	MLA 026
Name	ARTEMIS
Categories	General
Subcategory	Modern
	Decorative
Type	Ceiling lamp
Finishing	RAL on request

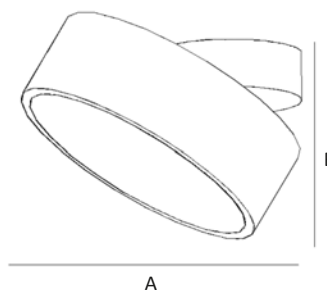

Product Specifications		General Information		Lamp Specifications & Dimensions	
Product Code	MLA 026	Suspension System	N/A	Lamp Holder	LED
Body	Metal	Protection	IP40	Type	SAMSUNG
Number of light source	1	Installation	Indoor	Luminous Flux	100 lm/W
Light source color	2700 K → 6000 K	Mounting	Surface mounted	Power	40W
Cap-Base	N/A	Warranty Period	2 years	Colour Temperature	2700 K → 6000 K
Light source replacable	Yes			A	50cm
Luminaire light beam	180°			B	20cm
				Custom Dimensions	On request

MLA 027

OLA S1



Product	
Code	MLA 027
Name	OLA S1
Categories	General
Subcategory	Modern
	Decorative
Type	Pendant
Finishing	On request



Product Specifications		General Information		Lamp Specifications & Dimensions	
Product Code	MLA 027	Suspension System	1 wire set	Lamp Holder	E27
Body	Metal	Protection	IP40	Type	LED
Number of light source	1	Installation	Indoor	Luminous Flux	80 lm/W
Light source color	2700 K -> 6000 K	Mounrting	Pendant	Power	10W
Cap-Base	6cm	Warranty Period	2 years	Colour Temperature	2700 K -> 6000 K
Light source replacable	Yes			A	40cm
Luminaire light beam	180°			B	120cm
				Custom Dimensions	On request

MLA 028

OLA S2



Product	
Code	MLA 028
Name	OLA S2
Categories	General
Subcategory	Modern
	Decorative
Type	Pendant
Finishing	RAL on request

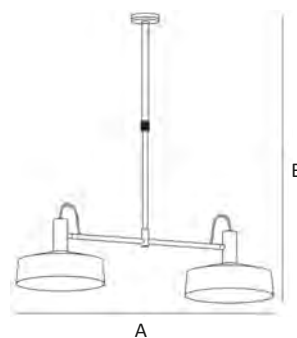

Product Specifications		General Information		Lamp Specifications & Dimensions	
Product Code	MLA 028	Suspension System	2 wire set	Lamp Holder	E27
Body	Metal	Protection	IP40	Type	LED
Number of light source	2	Installation	Indoor	Luminous Flux	80 lm/W
Light source color	2700 K -> 6000 K	Mounting	Pendant	Power	2x10W
Cap-Base	N/A	Warranty Period	2 years	Colour Temperature	2700 K -> 6000 K
Light source replacable	Yes			A	120cm
Luminaire light beam	180°			B	150cm
				Custom Dimensions	On request

MLA 029

OLA W1



Product	
Code	MLA 029
Name	OLA W1
Categories	General
Subcategory	Modern
	Decorative
Type	Wall lamp
Finishing	On request



Product Specifications		General Information		Lamp Specifications & Dimensions	
Product Code	MLA 029	Suspension System	N/A	Lamp Holder	E27
Body	Metal	Protection	IP40	Type	LED
Number of light source	1	Installation	Indoor	Luminous Flux	80 lm/W
Light source color	2700 K → 6000 K	Mounting	Wall mounted	Power	10W
Cap-Base	10cm	Warranty Period	2 years	Colour Temperature	2700 K → 6000 K
Light source replacable	Yes			A	30cm
Luminaire light beam	180°			B	40cm
				Custom Dimensions	On request

MLA 030

OLA W2



Product	
Code	MLA 030
Name	OLA W2
Categories	General
Subcategory	Modern
	Decorative
Type	Wall lamp
Finishing	RAL on request

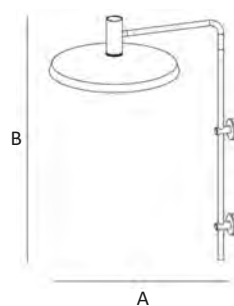

Product Specifications		General Information		Lamp Specifications & Dimensions	
Product Code	MLA 030	Suspension System	N/A	Lamp Holder	E27
Body	Metal	Protection	IP40	Type	LED
Number of light source	1	Installation	Indoor	Luminous Flux	80 lm/W
Light source color	2700 K → 6000 K	Mounting	Wall mounted	Power	10W
Cap-Base	N/A	Warranty Period	2 years	Colour Temperature	2700 K → 6000 K
Light source replacable	Yes			A	50cm
Luminaire light beam	180°			B	100cm
				Custom Dimensions	On request

MLA 031

OLA W3



Product	
Code	MLA 031
Name	OLA W3
Categories	General
Subcategory	Modern
	Decorative
Type	Wall lamp
Finishing	On request

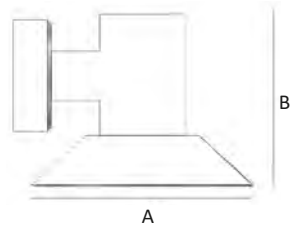

Product Specifications		General Information		Lamp Specifications & Dimensions	
Product Code	MLA 031	Suspension System	N/A	Lamp Holder	E27
Body	Metal	Protection	IP40	Type	LED
Number of light source	1	Installation	Indoor	Luminous Flux	80 lm/W
Light source color	2700 K → 6000 K	Mournting	Wall mounted	Power	10W
Cap-Base	10cm	Warranty Period	2 years	Colour Temperature	2700 K → 6000 K
Light source replacable	Yes			A	25cm
Luminaire light beam	180°			B	35cm
				Custom Dimensions	On request

MLA 032

PHASE



Product	
Code	MLA 032
Name	PHASE
Categories	General
Subcategory	Modern
	Decorative
Type	Wall lamp
Finishing	RAL on request

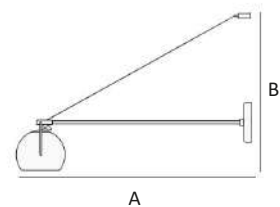

Product Specifications		General Information		Lamp Specifications & Dimensions	
Product Code	MLA 032	Suspension System	1 wire set	Lamp Holder	E14
Body	Metal	Protection	IP40	Type	LED
Number of light source	1	Installation	Indoor	Luminous Flux	80 lm/W
Light source color	2700 K → 6000 K	Mounting	Wall mounted	Power	6W
Cap-Base	N/A	Warranty Period	2 years	Colour Temperature	2700 K → 6000 K
Light source replacable	Yes			A	65cm
Luminaire light beam	180°			B	45cm
				Custom Dimensions	On request

MLA 033

UP TOWN

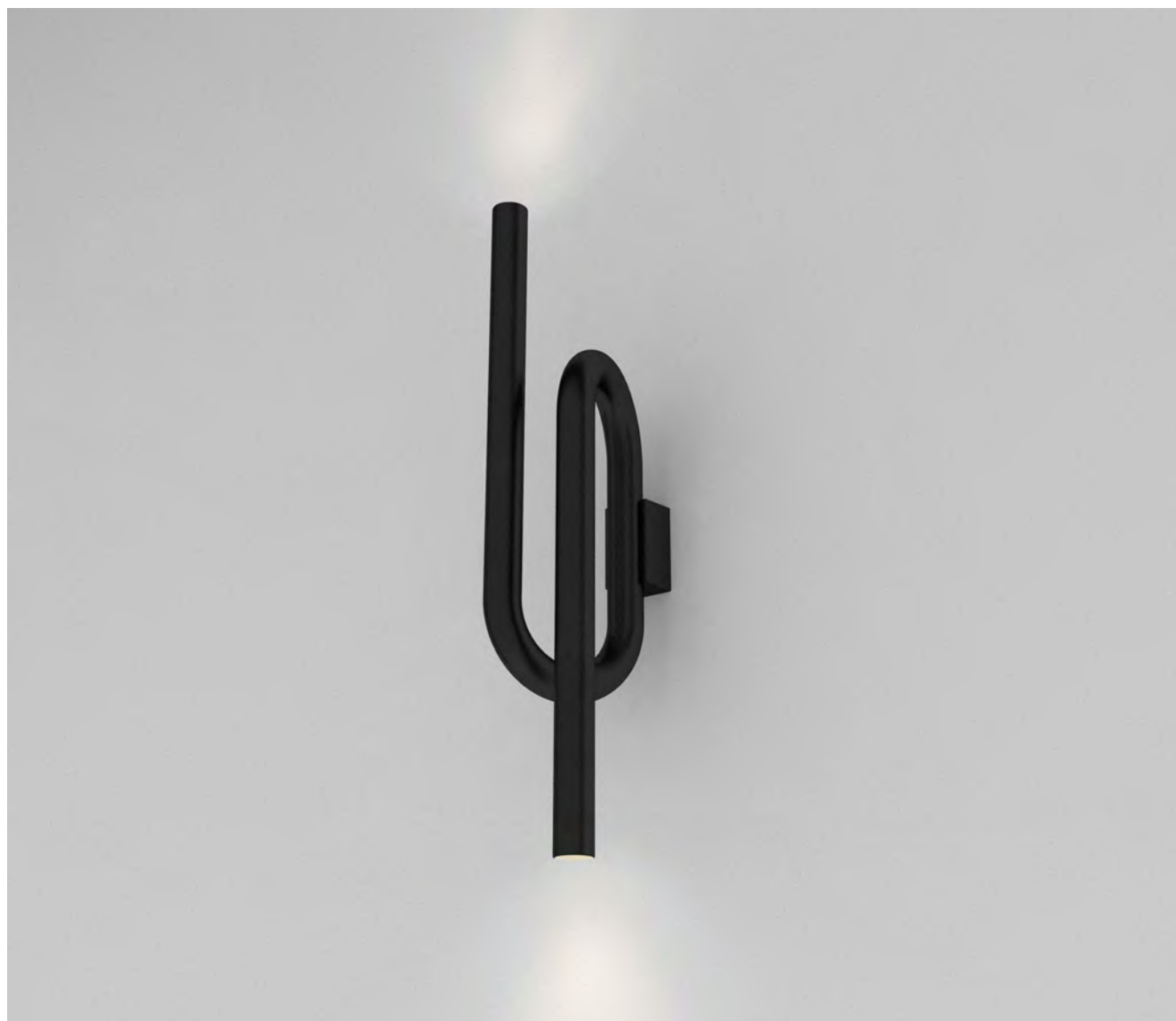

Product	
Code	MLA 033
Name	UP TOWN
Categories	General
Subcategory	Modern
	Decorative
Type	Wall lamp
Finishing	On request

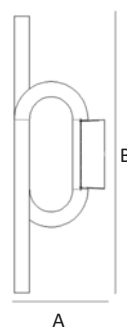

Product Specifications		General Information		Lamp Specifications & Dimensions	
Product Code	MLA 033	Suspension System	N/A	Lamp Holder	LED
Body	Metal	Protection	IP40	Type	Power LED
Number of light source	2	Installation	Indoor	Luminous Flux	100 lm/W
Light source color	2700 K → 6000 K	Mournting	Wall mounted	Power	2x3W
Cap-Base	4x10cm	Warranty Period	2 years	Colour Temperature	2700 K → 6000 K
Light source replacable	Yes			A	20cm
Luminaire light beam	180°			B	40cm
				Custom Dimensions	On request

MLA 034

SPY



Product	
Code	MLA 034
Name	SPY
Categories	General
Subcategory	Modern
	Decorative
Type	Wall lamp
Finishing	RAL on request

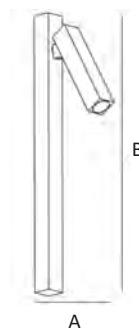

Product Specifications		General Information		Lamp Specifications & Dimensions	
Product Code	MLA 034	Suspension System	N/A	Lamp Holder	LED
Body	Metal	Protection	IP40	Type	Power LED
Number of light source	1	Installation	Indoor	Luminous Flux	100 lm/W
Light source color	2700 K → 6000 K	Mounting	Wall mounted	Power	3W
Cap-Base	N/A	Warranty Period	2 years	Colour Temperature	2700 K → 6000 K
Light source replacable	Yes			A	15cm
Luminaire light beam	180°			B	40cm
				Custom Dimensions	On request

MLA 035

PUP

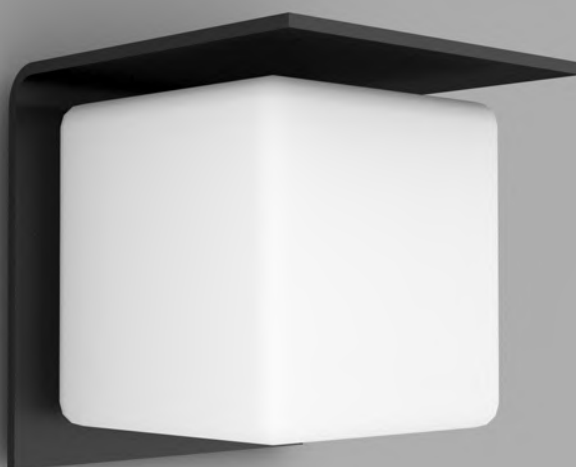

Product	
Code	MLA 035
Name	PUP
Categories	General
Subcategory	Modern
	Decorative
Type	Wall lamp
Finishing	On request

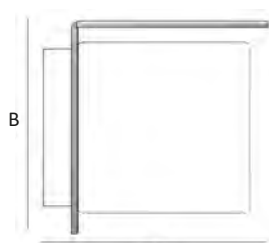

A

Product Specifications		General Information		Lamp Specifications & Dimensions	
Product Code	MLA 035	Suspension System	N/A	Lamp Holder	G9
Body	Metal	Protection	IP40	Type	LED
Number of light source	1	Installation	Indoor	Luminous Flux	80 lm/W
Light source color	2700 K -> 6000 K	Mounrting	Wall mounted	Power	4W
Cap-Base	18x18cm	Warranty Period	2 years	Colour Temperature	2700 K -> 6000 K
Light source replacable	Yes			A	12cm
Luminaire light beam	180°			B	12cm
				Custom Dimensions	On request

MLA 036

MONO

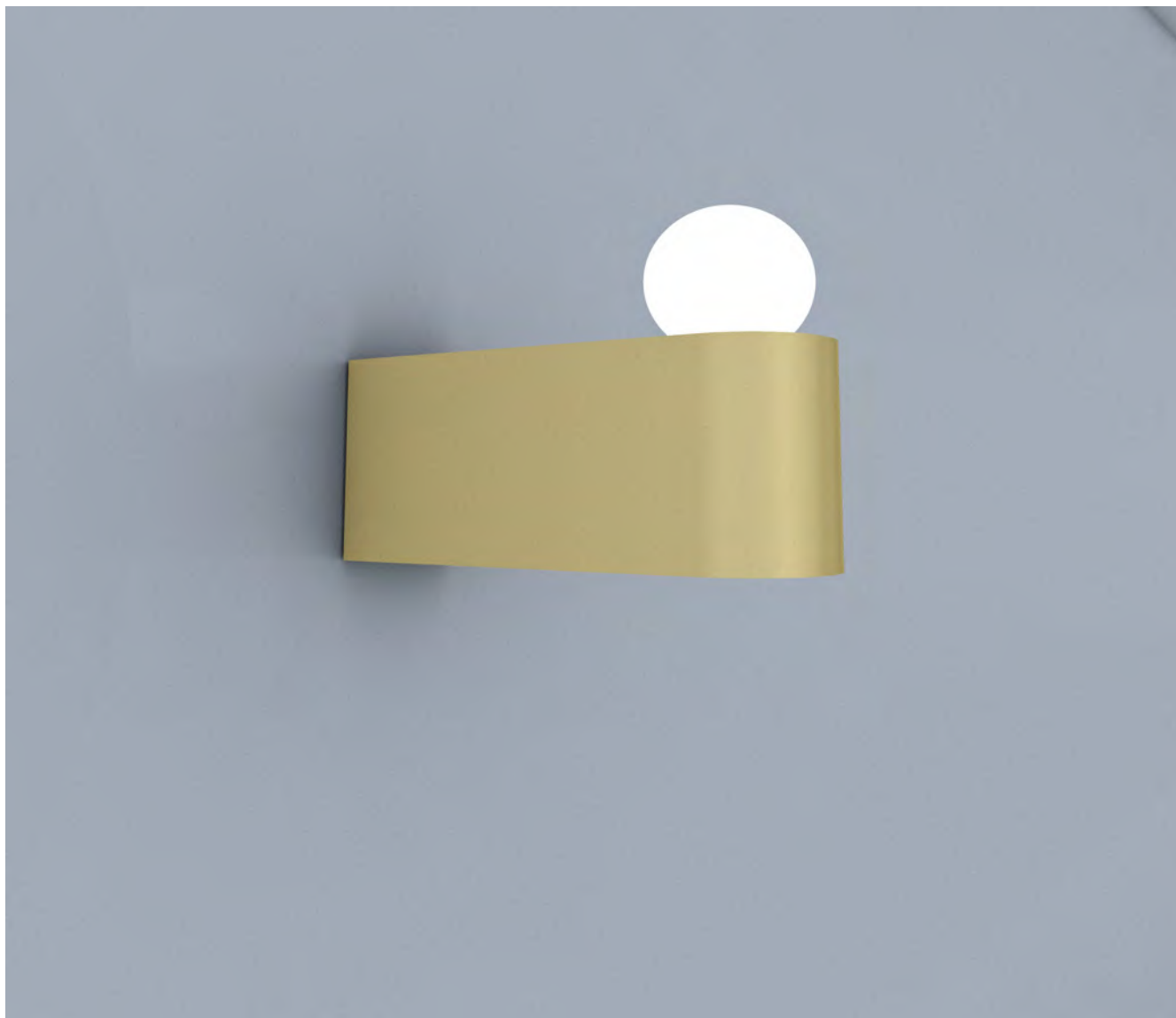

Product	
Code	MLA 036
Name	MONO
Categories	General
Subcategory	Modern
	Decorative
Type	Wall lamp
Finishing	RAL on request

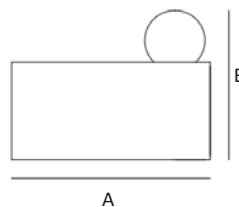

Product Specifications		General Information		Lamp Specifications & Dimensions	
Product Code	MLA 036	Suspension System	N/A	Lamp Holder	G4
Body	Metal	Protection	IP40	Type	LED
Number of light source	1	Installation	Indoor	Luminous Flux	80 lm/W
Light source color	2700 K → 6000 K	Mounting	Wall mounted	Power	2W
Cap-Base	N/A	Warranty Period	2 years	Colour Temperature	2700 K → 6000 K
Light source replacable	Yes			A	30cm
Luminaire light beam	180°			B	22cm
				Custom Dimensions	On request

MLA 037

GOBI



Product	
Code	MLA 037
Name	GOBI
Categories	General
Subcategory	Modern
	Decorative
Type	Pendant
Finishing	On request

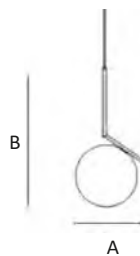

Product Specifications		General Information		Lamp Specifications & Dimensions	
Product Code	MLA 037	Suspension System	1 wire set	Lamp Holder	E27
Body	Metal	Protection	IP40	Type	LED
Number of light source	1	Installation	Indoor	Luminous Flux	80 lm/W
Light source color	2700 K → 6000 K	Mounting	Pendant	Power	10W
Cap-Base	6cm	Warranty Period	2 years	Colour Temperature	2700 K → 6000 K
Light source replacable	Yes			A	30cm
Luminaire light beam	180°			B	50cm
				Custom Dimensions	On request



MLA 038

GOBI



Product	
Code	MLA 038
Name	GOBI
Categories	General
Subcategory	Modern
	Decorative
Type	Table lamp
Finishing	RAL on request

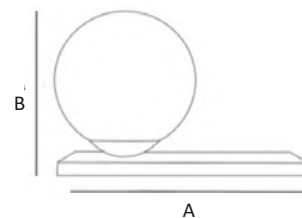

Product Specifications		General Information		Lamp Specifications & Dimensions	
Product Code	MLA 038	Suspension System	N/A	Lamp Holder	E14
Body	Metal	Protection	IP40	Type	LED
Number of light source	1	Installation	Indoor	Luminous Flux	80 lm/W
Light source color	2700 K → 6000 K	Mounting	Stand alone	Power	4W
Cap-Base	N/A	Warranty Period	2 years	Colour Temperature	2700 K → 6000 K
Light source replacable	Yes			A	15x30cm
Luminaire light beam	180°			B	18cm
				Custom Dimensions	On request

CHL 001

ARIA



Product	
Code	CHL 001
Name	ARIA
Categories	General
Subcategory	Modern
	Decorative
Type	Wall lamp
Finishing	On request

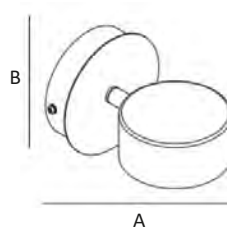

Product Specifications		General Information		Lamp Specifications & Dimensions	
Product Code	CHL 001	Suspension System	N/A	Lamp Holder	LED
Body	Metal	Protection	IP40	Type	Power LED
Number of light source	1	Installation	Indoor	Luminous Flux	100 lm/W
Light source color	2700 K → 6000 K	Mournting	Wall mounted	Power	9W
Cap-Base	12cm	Warranty Period	2 years	Colour Temperature	2700 K → 6000 K
Light source replacable	Yes			A	12cm
Luminaire light beam	180°			B	12cm
				Custom Dimensions	On request

CHL 002

ARIA



Product	
Code	CHL 002
Name	ARIA
Categories	General
Subcategory	Modern
	Decorative
Type	Pendant
Finishing	RAL on request

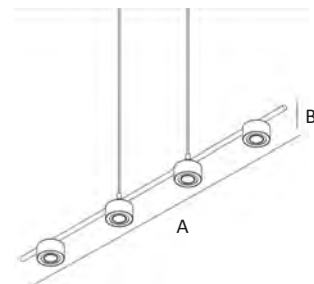

Product Specifications		General Information		Lamp Specifications & Dimensions	
Product Code	CHL 002	Suspension System	2 wire set	Lamp Holder	LED
Body	Metal	Protection	IP40	Type	Power LED
Number of light source	4	Installation	Indoor	Luminous Flux	100 lm/W
Light source color	2700 K → 6000 K	Mounting	Pendant	Power	4x9W
Cap-Base	N/A	Warranty Period	2 years	Colour Temperature	2700 K → 6000 K
Light source replacable	Yes			A	110cm
Luminaire light beam	180°			B	15cm
				Custom Dimensions	On request



CHL 003

ARIA



Product	
Code	CHL 003
Name	ARIA
Categories	General
Subcategory	Modern
	Decorative
Type	Floor lamp
Finishing	On request

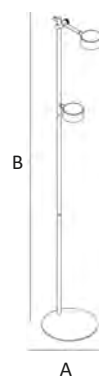

Product Specifications		General Information		Lamp Specifications & Dimensions	
Product Code	CHL 003	Suspension System	N/A	Lamp Holder	LED
Body	Metal	Protection	IP40	Type	Power LED
Number of light source	2	Installation	Indoor	Luminous Flux	100 lm/W
Light source color	2700 K → 6000 K	Mounrting	Stand alone	Power	2x9W
Cap-Base	6cm	Warranty Period	2 years	Colour Temperature	2700 K → 6000 K
Light source replacable	Yes			A	30cm
Luminaire light beam	180°			B	150cm
				Custom Dimensions	On request



CHL 004

ARIA



Product	
Code	CHL 004
Name	ARIA
Categories	General
Subcategory	Modern
	Decorative
Type	Table lamp
Finishing	RAL on request

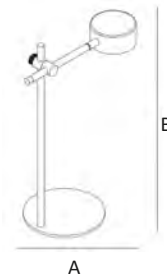

Product Specifications		General Information		Lamp Specifications & Dimensions	
Product Code	CHL 004	Suspension System	N/A	Lamp Holder	LED
Body	Metal	Protection	IP40	Type	Power LED
Number of light source	1	Installation	Indoor	Luminous Flux	100 lm/W
Light source color	2700 K → 6000 K	Mounting	Stand alone	Power	9W
Cap-Base	N/A	Warranty Period	2 years	Colour Temperature	2700 K → 6000 K
Light source replacable	Yes			A	26cm
Luminaire light beam	180°			B	45cm
				Custom Dimensions	On request

CHL 005

BELL



Product	
Code	CHL 005
Name	BELL
Categories	General
Subcategory	Modern
	Decorative
Type	Wall lamp
Finishing	On request

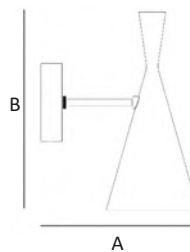

Product Specifications		General Information		Lamp Specifications & Dimensions	
Product Code	CHL 005	Suspension System	N/A	Lamp Holder	E14
Body	Metal	Protection	IP40	Type	LED
Number of light source	1	Installation	Indoor	Luminous Flux	80 lm/W
Light source color	2700 K → 6000 K	Mournting	Wall mounted	Power	6W
Cap-Base	10cm	Warranty Period	2 years	Colour Temperature	2700 K → 6000 K
Light source replacable	Yes			A	30cm
Luminaire light beam	180°			B	35cm
				Custom Dimensions	On request

CHL 006

BELL



Product	
Code	CHL 006
Name	BELL
Categories	General
Subcategory	Modern
	Decorative
Type	Pendant
Finishing	RAL on request

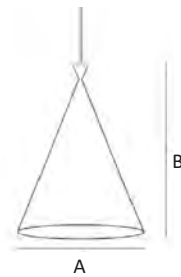

Product Specifications		General Information		Lamp Specifications & Dimensions	
Product Code	CHL 006	Suspension System	1 wire set	Lamp Holder	E14
Body	Metal	Protection	IP40	Type	LED
Number of light source	1	Installation	Indoor	Luminous Flux	80 lm/W
Light source color	2700 K → 6000 K	Mounting	Pendant	Power	6W
Cap-Base	N/A	Warranty Period	2 years	Colour Temperature	2700 K → 6000 K
Light source replacable	Yes			A	22cm
Luminaire light beam	180°			B	35cm
				Custom Dimensions	On request

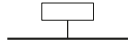

CHL 007

BELL



Product	
Code	CHL 007
Name	BELL
Categories	General
Subcategory	Modern
	Decorative
Type	Table lamp
Finishing	On request

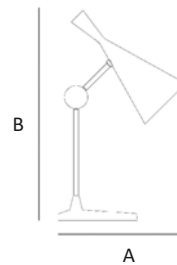

Product Specifications		General Information		Lamp Specifications & Dimensions	
Product Code	CHL 007	Suspension System	N/A	Lamp Holder	E14
Body	Metal	Protection	IP40	Type	LED
Number of light source	1	Installation	Indoor	Luminous Flux	80 lm/W
Light source color	2700 K → 6000 K	Mournting	Stand alone	Power	6W
Cap-Base	N/A	Warranty Period	2 years	Colour Temperature	2700 K → 6000 K
Light source replacable	Yes			A	30cm
Luminaire light beam	180°			B	60cm
				Custom Dimensions	On request



CHL 008

BELL

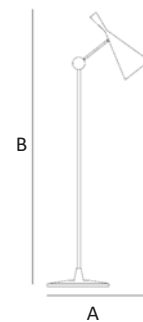

Product	
Code	CHL 008
Name	BELL
Categories	General
Subcategory	Modern
	Decorative
Type	Floor lamp
Finishing	RAL on request

Product Specifications	General Information		Lamp Specifications & Dimensions		
Product Code	CHL 008	Suspension System	N/A	Lamp Holder	E14
Body	Metal	Protection	IP40	Type	LED
Number of light source	1	Installation	Indoor	Luminous Flux	80 lm/W
Light source color	2700 K → 6000 K	Mounting	Stand alone	Power	6W
Cap-Base	N/A	Warranty Period	2 years	Colour Temperature	2700 K → 6000 K
Light source replacable	Yes			A	35cm
Luminaire light beam	180°			B	150cm
				Custom Dimensions	On request

CHL 009

CUT



Product	
Code	CHL 009
Name	CUT
Categories	General
Subcategory	Modern
	Decorative
Type	Wall lamp
Finishing	On request

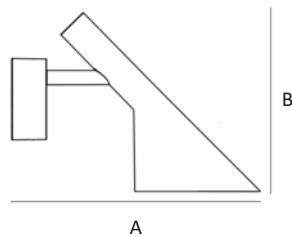

Product Specifications		General Information		Lamp Specifications & Dimensions	
Product Code	CHL 009	Suspension System	N/A	Lamp Holder	E27
Body	Metal	Protection	IP40	Type	LED
Number of light source	1	Installation	Indoor	Luminous Flux	80 lm/W
Light source color	2700 K → 6000 K	Mounting	Wall mounted	Power	10W
Cap-Base	10cm	Warranty Period	2 years	Colour Temperature	2700 K → 6000 K
Light source replaceable	Yes			A	40cm
Luminaire light beam	180°			B	30cm
				Custom Dimensions	On request



CHL 010

CUT



Product	
Code	CHL 010
Name	CUT
Categories	General
Subcategory	Modern
	Decorative
Type	Floor lamp
Finishing	RAL on request



Product Specifications		General Information		Lamp Specifications & Dimensions	
Product Code	CHL 010	Suspension System	N/A	Lamp Holder	E27
Body	Metal	Protection	IP40	Type	LED
Number of light source	1	Installation	Indoor	Luminous Flux	80 lm/W
Light source color	2700 K -> 6000 K	Mounting	Stand alone	Power	10W
Cap-Base	N/A	Warranty Period	2 years	Colour Temperature	2700 K -> 6000 K
Light source replacable	Yes			A	34cm
Luminaire light beam	180°			B	130cm
				Custom Dimensions	On request

CHL 011

ETOILE



Product	
Code	CHL 011
Name	ETOILE
Categories	General
Subcategory	Modern
	Decorative
Type	Wall lamp
Finishing	On request

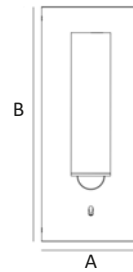

Product Specifications		General Information		Lamp Specifications & Dimensions	
Product Code	CHL 011	Suspension System	N/A	Lamp Holder	LED
Body	Metal	Protection	IP40	Type	Power LED
Number of light source	1	Installation	Indoor	Luminous Flux	100 lm/W
Light source color	2700 K → 6000 K	Mourting	Wall mounted	Power	3W
Cap-Base	N/A	Warranty Period	2 years	Colour Temperature	2700 K → 6000 K
Light source replacable	Yes			A	8cm
Luminaire light beam	180°			B	20cm
				Custom Dimensions	On request

CHL 012

ETOILE



Product	
Code	CHL 012
Name	ETOILE
Categories	General
Subcategory	Modern
	Decorative
Type	Pendant
Finishing	RAL on request

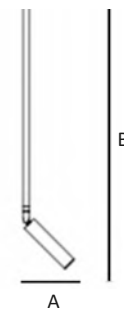

Product Specifications		General Information		Lamp Specifications & Dimensions	
Product Code	CHL 012	Suspension System	1 wire set	Lamp Holder	LED
Body	Metal	Protection	IP40	Type	Power LED
Number of light source	1	Installation	Indoor	Luminous Flux	100 lm/W
Light source color	2700 K -> 6000 K	Mounting	Pendant	Power	3W
Cap-Base	10cm	Warranty Period	2 years	Colour Temperature	2700 K -> 6000 K
Light source replacable	Yes			A	10cm
Luminaire light beam	180°			B	120cm
				Custom Dimensions	On request

CHL 013

READY



Product	
Code	CHL 013
Name	READY
Categories	General
Subcategory	Modern
	Decorative
Type	Wall lamp
Finishing	On request

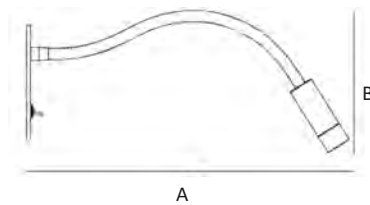

Product Specifications		General Information		Lamp Specifications & Dimensions	
Product Code	CHL 013	Suspension System	N/A	Lamp Holder	LED
Body	Metal	Protection	IP40	Type	Power LED
Number of light source	1	Installation	Indoor	Luminous Flux	100 lm/W
Light source color	2700 K → 6000 K	Mournting	Wall mounted	Power	3W
Cap-Base	10x12cm	Warranty Period	2 years	Colour Temperature	2700 K → 6000 K
Light source replacable	Yes			A	42cm
Luminaire light beam	180°			B	12cm
				Custom Dimensions	On request

CHL 014

READY



Product	
Code	CHL 014
Name	READY
Categories	General
Subcategory	Modern
	Decorative
Type	Pendant
Finishing	RAL on request

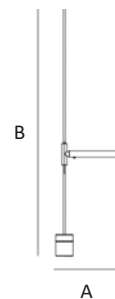

Product Specifications		General Information		Lamp Specifications & Dimensions	
Product Code	CHL 014	Suspension System	1 wire set	Lamp Holder	LED
Body	Metal	Protection	IP40	Type	Power LED
Number of light source	1	Installation	Indoor	Luminous Flux	100 lm/W
Light source color	2700 K → 6000 K	Mounting	Pendant	Power	3W
Cap-Base	10cm	Warranty Period	2 years	Colour Temperature	2700 K → 6000 K
Light source replacable	Yes			A	30cm
Luminaire light beam	180°			B	120cm
				Custom Dimensions	On request

CHL 015

READY



Product	
Code	CHL 015
Name	READY
Categories	General
Subcategory	Modern
	Decorative
Type	Ceiling lamp
Finishing	RAL on request

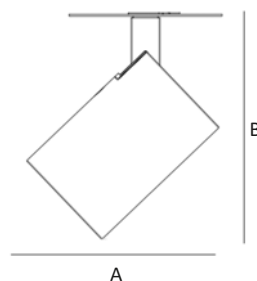

Product Specifications		General Information		Lamp Specifications & Dimensions	
Product Code	CHL 015	Suspension System	N/A	Lamp Holder	GU10
Body	Metal	Protection	IP40	Type	LED
Number of light source	1	Installation	Indoor	Luminous Flux	80 lm/W
Light source color	2700 K → 6000 K	Mounting	Ceiling recessed	Power	6W
Cap-Base	N/A	Warranty Period	2 years	Colour Temperature	2700 K → 6000 K
Light source replacable	Yes			A	8cm
Luminaire light beam	180°			B	16cm
				Custom Dimensions	On request



CHL 016

READY



Product	
Code	CHL 016
Name	READY
Categories	General
Subcategory	Modern
	Decorative
Type	Table lamp
Finishing	On request

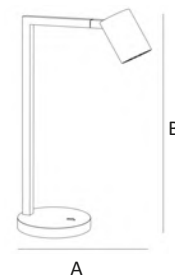

Product Specifications		General Information		Lamp Specifications & Dimensions	
Product Code	CHL 016	Suspension System	N/A	Lamp Holder	GU10
Body	Metal	Protection	IP40	Type	LED
Number of light source	1	Installation	Indoor	Luminous Flux	80 lm/W
Light source color	2700 K -> 6000 K	Mourting	Stand alone	Power	5W
Cap-Base	N/A	Warranty Period	2 years	Colour Temperature	2700 K -> 6000 K
Light source replacable	Yes			A	25cm
Luminaire light beam	180°			B	50cm
				Custom Dimensions	On request



CHL 017

READY



Product	
Code	CHL 017
Name	READY
Categories	General
Subcategory	Modern
	Decorative
Type	Floor lamp
Finishing	RAL on request



Product Specifications		General Information		Lamp Specifications & Dimensions	
Product Code	CHL 017	Suspension System	N/A	Lamp Holder	GU10
Body	Metal	Protection	IP40	Type	LED
Number of light source	1	Installation	Indoor	Luminous Flux	80 lm/W
Light source color	2700 K → 6000 K	Mounting	Stand alone	Power	6W
Cap-Base	N/A	Warranty Period	2 years	Colour Temperature	2700 K → 6000 K
Light source replacable	Yes			A	35m
Luminaire light beam	180°			B	150cm
				Custom Dimensions	On request

CHL 018

PIA



Product	
Code	CHL 018
Name	PIA
Categories	General
Subcategory	Modern
	Decorative
Type	Wall lamp
Finishing	On request

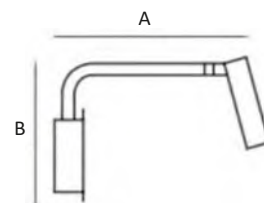

Product Specifications		General Information		Lamp Specifications & Dimensions	
Product Code	CHL 018	Suspension System	N/A	Lamp Holder	LED
Body	Metal	Protection	IP40	Type	Power LED
Number of light source	1	Installation	Indoor	Luminous Flux	100 lm/W
Light source color	2700 K → 6000 K	Mourting	Wall mounted	Power	3W
Cap-Base	12cm	Warranty Period	2 years	Colour Temperature	2700 K → 6000 K
Light source replacable	Yes			A	38cm
Luminaire light beam	180°			B	22cm
				Custom Dimensions	On request

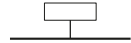

CHL 019

PIA



Product	
Code	CHL 019
Name	PIA
Categories	General
Subcategory	Modern
	Decorative
Type	Table lamp
Finishing	On request

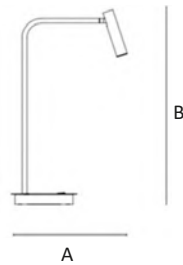

Product Specifications		General Information		Lamp Specifications & Dimensions	
Product Code	CHL 019	Suspension System	N/A	Lamp Holder	LED
Body	Metal	Protection	IP40	Type	Power LED
Number of light source	1	Installation	Indoor	Luminous Flux	10 lm/W
Light source color	2700 K -> 6000 K	Mourting	Stand alone	Power	3W
Cap-Base	N/A	Warranty Period	2 years	Colour Temperature	2700 K -> 6000 K
Light source replacable	Yes			A	32cm
Luminaire light beam	180°			B	56cm
				Custom Dimensions	On request



CHL 020

PIA



Product	
Code	CHL 020
Name	PIA
Categories	General
Subcategory	Modern
	Decorative
Type	Floor lamp
Finishing	RAL on request

Product Specifications		General Information		Lamp Specifications & Dimensions	
Product Code	CHL 020	Suspension System	N/A	Lamp Holder	LED
Body	Metal	Protection	IP40	Type	Power LED
Number of light source	1	Installation	Indoor	Luminous Flux	100 lm/W
Light source color	2700 K -> 6000 K	Mounting	Stand alone	Power	3W
Cap-Base	N/A	Warranty Period	2 years	Colour Temperature	2700 K -> 6000 K
Light source replacable	Yes			A	45cm
Luminaire light beam	180°			B	150cm
				Custom Dimensions	On request



CHL 021

STROM



Product	
Code	CHL 021
Name	STROM
Categories	General
Subcategory	Modern
	Decorative
Type	Table lamp
Finishing	On request



Product Specifications		General Information		Lamp Specifications & Dimensions	
Product Code	CHL 021	Suspension System	N/A	Lamp Holder	E14
Body	Metal	Protection	IP40	Type	LED
Number of light source	1	Installation	Indoor	Luminous Flux	80 lm/W
Light source color	2700 K → 6000 K	Mournting	Stand alone	Power	6W
Cap-Base	N/A	Warranty Period	2 years	Colour Temperature	2700 K → 6000 K
Light source replacable	Yes			A	30cm
Luminaire light beam	180°			B	55cm
				Custom Dimensions	On request



CHL 022

STROM



Product	
Code	CHL022
Name	STROM
Categories	General
Subcategory	Modern
	Decorative
Type	Floor lamp
Finishing	RAL on request

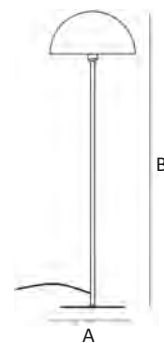

Product Specifications		General Information		Lamp Specifications & Dimensions	
Product Code	CHL022	Suspension System	N/A	Lamp Holder	E27
Body	Metal	Protection	IP40	Type	LED
Number of light source	1	Installation	Indoor	Luminous Flux	80 lm/W
Light source color	2700 K → 6000 K	Mounting	Stand alone	Power	10W
Cap-Base	N/A	Warranty Period	2 years	Colour Temperature	2700 K → 6000 K
Light source replacable	Yes			A	40cm
Luminaire light beam	180°			B	150cm
				Custom Dimensions	On request



CHL 023

ARIK



Product	
Code	CHL 023
Name	ARIK
Categories	General
Subcategory	Modern
	Decorative
Type	Table lamp
Finishing	On request

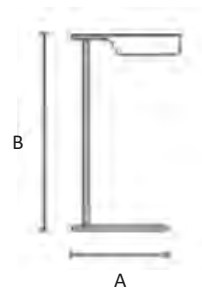

Product Specifications		General Information		Lamp Specifications & Dimensions	
Product Code	CHL 023	Suspension System	N/A	Lamp Holder	G9
Body	Metal	Protection	IP40	Type	LED
Number of light source	1	Installation	Indoor	Luminous Flux	80 lm/W
Light source color	2700 K → 6000 K	Mournting	Stand alone	Power	9W
Cap-Base	N/A	Warranty Period	2 years	Colour Temperature	2700 K → 6000 K
Light source replacable	Yes			A	28cm
Luminaire light beam	180°			B	55cm
				Custom Dimensions	On request



CHL 024

ARIK



Product	
Code	CHL 024
Name	ARIK
Categories	General
Subcategory	Modern
	Decorative
Type	Floor lamp
Finishing	RAL on request

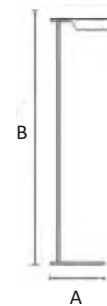

Product Specifications		General Information		Lamp Specifications & Dimensions	
Product Code	CHL 024	Suspension System	N/A	Lamp Holder	G9
Body	Metal	Protection	IP40	Type	LED
Number of light source	1	Installation	Indoor	Luminous Flux	80 lm/W
Light source color	2700 K → 6000 K	Mounting	Stand alone	Power	9W
Cap-Base	N/A	Warranty Period	2 years	Colour Temperature	2700 K → 6000 K
Light source replacable	Yes			A	28cm
Luminaire light beam	180°			B	145cm
				Custom Dimensions	On request

CHL 025

ALMA



Product	
Code	CHL 025
Name	ALMA
Categories	General
Subcategory	Modern
	Decorative
Type	Wall lamp
Finishing	On request

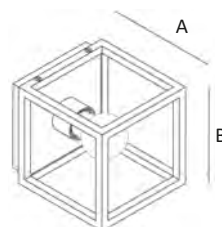

Product Specifications		General Information		Lamp Specifications & Dimensions	
Product Code	CHL 025	Suspension System	N/A	Lamp Holder	E14
Body	Metal	Protection	IP40	Type	LED
Number of light source	1	Installation	Indoor	Luminous Flux	80 lm/W
Light source color	2700 K → 6000 K	Mounting	Wall mounted	Power	6W
Cap-Base	14cm	Warranty Period	2 years	Colour Temperature	2700 K → 6000 K
Light source replacable	Yes			A	18cm
Luminaire light beam	180°			B	16cm
				Custom Dimensions	On request

CHL 026

ALMA



Product	
Code	CHL 026
Name	ALMA
Categories	General
Subcategory	Modern
	Decorative
Type	Pendant
Finishing	RAL on request

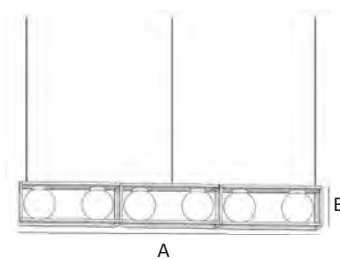

Product Specifications		General Information		Lamp Specifications & Dimensions	
Product Code	CHL 026	Suspension System	3 wire set	Lamp Holder	G9
Body	Metal	Protection	IP40	Type	LED
Number of light source	6	Installation	Indoor	Luminous Flux	80 lm/W
Light source color	2700 K → 6000 K	Mounting	Pendant	Power	9W
Cap-Base	N/A	Warranty Period	2 years	Colour Temperature	2700 K → 6000 K
Light source replacable	Yes			A	126cm
Luminaire light beam	180°			B	20cm
				Custom Dimensions	On request



CHL 027

ALMA



Product	
Code	CHL 027
Name	ALMA
Categories	General
Subcategory	Modern
	Decorative
Type	Table lamp
Finishing	On request

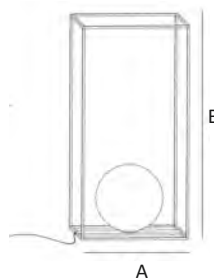

Product Specifications		General Information		Lamp Specifications & Dimensions	
Product Code	CHL 027	Suspension System	N/A	Lamp Holder	G9
Body	Metal	Protection	IP40	Type	LED
Number of light source	1	Installation	Indoor	Luminous Flux	80 lm/W
Light source color	2700 K → 6000 K	Mounrting	Stand alone	Power	9W
Cap-Base	N/A	Warranty Period	2 years	Colour Temperature	2700 K → 6000 K
Light source replacable	Yes			A	22cm
Luminaire light beam	180°			B	45cm
				Custom Dimensions	On request



CHL 028

ALMA



Product	
Code	CHL 028
Name	ALMA
Categories	General
Subcategory	Modern
Type	Decorative
Type	Floor lamp
Finishing	RAL on request



Product Specifications		General Information		Lamp Specifications & Dimensions	
Product Code	CHL 028	Suspension System	N/A	Lamp Holder	E27
Body	Metal	Protection	IP40	Type	LED
Number of light source	1	Installation	Indoor	Luminous Flux	80 lm/W
Light source color	2700 K → 6000 K	Mounting	Stand alone	Power	10W
Cap-Base	N/A	Warranty Period	2 years	Colour Temperature	2700 K → 6000 K
Light source replacable	Yes			A	42cm
Luminaire light beam	180°			B	165cm
				Custom Dimensions	On request

CHL 029

CITRUS

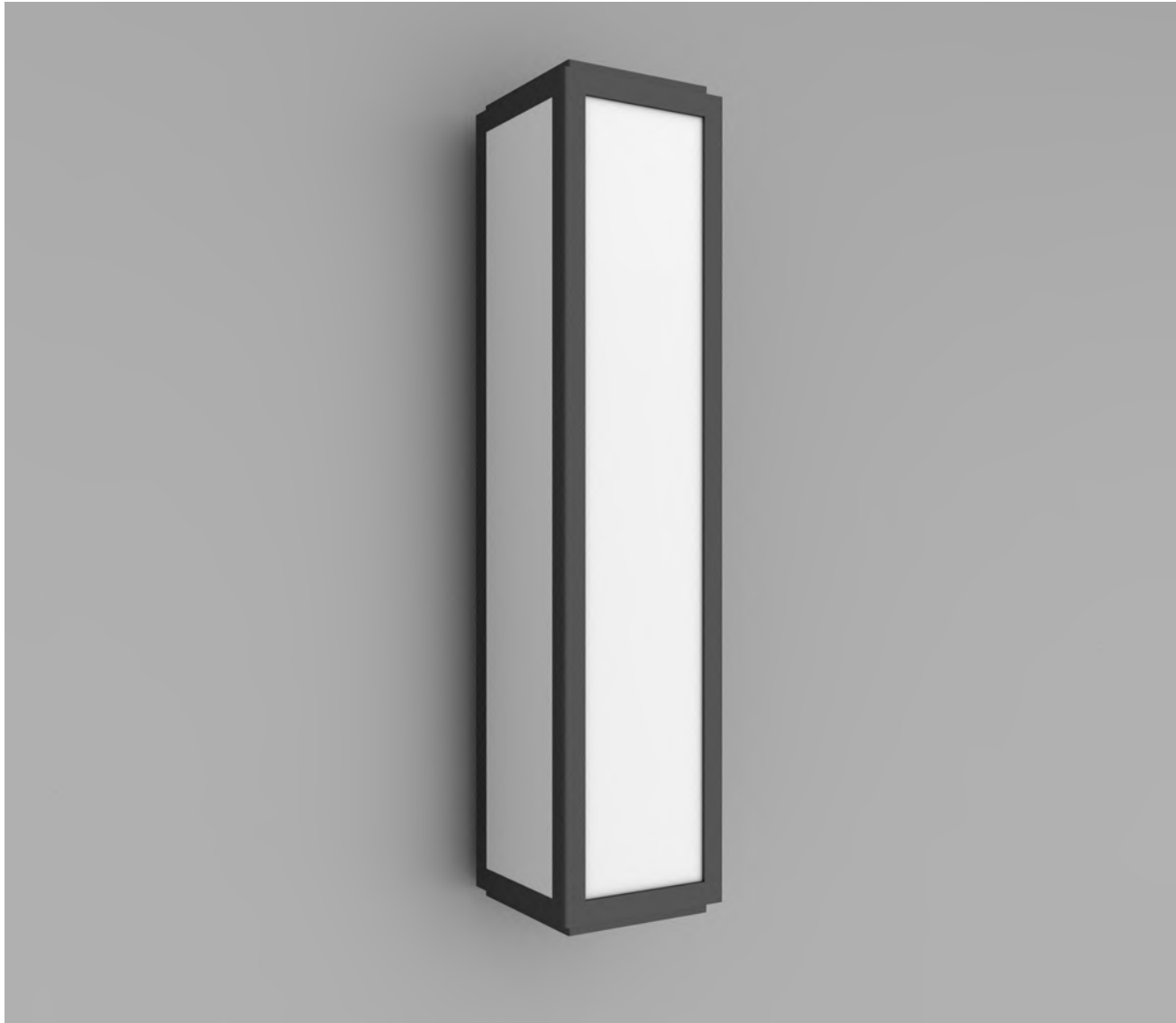

Product	
Code	CHL 029
Name	CITRUS
Categories	General
Subcategory	Modern
	Decorative
Type	Wall lamp
Finishing	On request



Product Specifications		General Information		Lamp Specifications & Dimensions	
Product Code	CHL 029	Suspension System	N/A	Lamp Holder	LED
Body	Metal	Protection	IP40	Type	SAMSUNG
Number of light source	1	Installation	Indoor	Luminous Flux	100 lm/W
Light source color	2700 K → 6000 K	Mournting	Wall mounted	Power	15W
Cap-Base	N/A	Warranty Period	2 years	Colour Temperature	2700 K → 6000 K
Light source replacable	Yes			A	10cm
Luminaire light beam	180°			B	45cm
				Custom Dimensions	On request



CHL 030

CITRUS

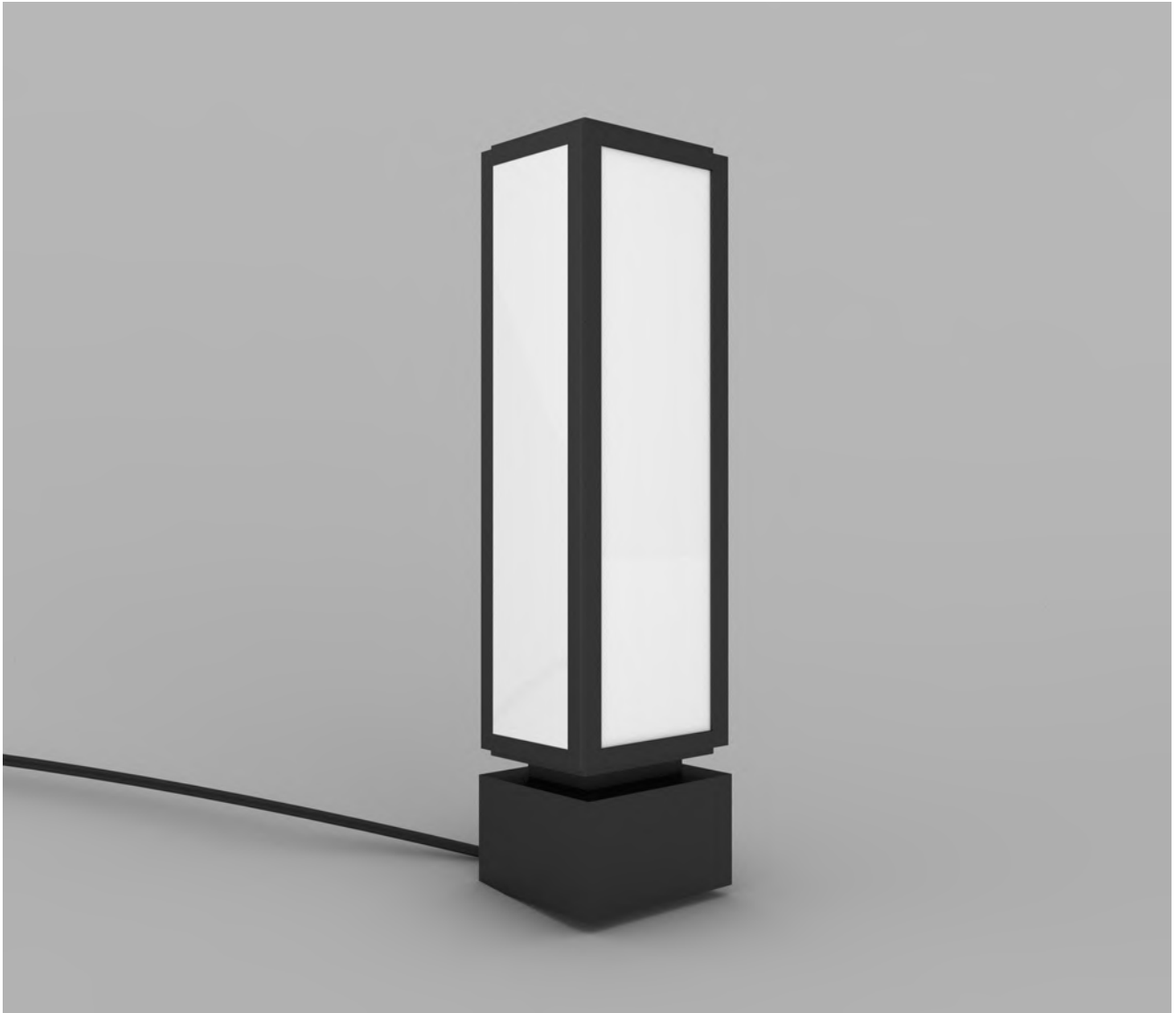

Product	
Code	CHL 030
Name	CITRUS
Categories	General
Subcategory	Modern
	Decorative
Type	Table lamp
Finishing	RAL on request

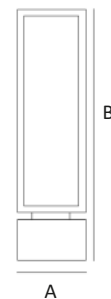

Product Specifications		General Information		Lamp Specifications & Dimensions	
Product Code	CHL 030	Suspension System	N/A	Lamp Holder	LED
Body	Metal	Protection	IP40	Type	SAMSUNG
Number of light source	1	Installation	Indoor	Luminous Flux	100 lm/W
Light source color	2700 K → 6000 K	Mounting	Stand alone	Power	10W
Cap-Base	N/A	Warranty Period	2 years	Colour Temperature	2700 K → 6000 K
Light source replaceable	Yes			A	12cm
Luminaire light beam	180°			B	37cm
				Custom Dimensions	On request

CHL 031

CITRUS



Product	
Code	CHL 031
Name	CITRUS
Categories	General
Subcategory	Modern
	Decorative
Type	Wall lamp
Finishing	On request

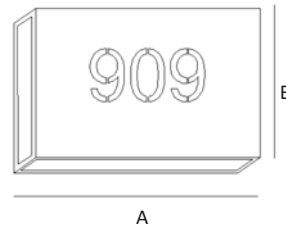

Product Specifications		General Information		Lamp Specifications & Dimensions	
Product Code	CHL 031	Suspension System	N/A	Lamp Holder	LED
Body	Metal	Protection	IP40	Type	SAMSUNG
Number of light source	1	Installation	Indoor	Luminous Flux	100 lm/W
Light source color	2700 K -> 6000 K	Mournting	Wall mounted	Power	4W
Cap-Base	N/A	Warranty Period	2 years	Colour Temperature	2700 K -> 6000 K
Light source replaceable	Yes			A	15cm
Luminaire light beam	180°			B	10cm
				Custom Dimensions	On request

CHL 032

YVETTE



Product	
Code	CHL 032
Name	YVETTE
Categories	General
Subcategory	Modern
	Decorative
Type	Wall lamp
Finishing	RAL on request



Product Specifications		General Information		Lamp Specifications & Dimensions	
Product Code	CHL 032	Suspension System	N/A	Lamp Holder	LED
Body	Metal	Protection	IP40	Type	SAMSUNG
Number of light source	1	Installation	Indoor	Luminous Flux	100 lm/W
Light source color	2700 K → 6000 K	Mounting	Wall mounted	Power	5W
Cap-Base	6cm	Warranty Period	2 years	Colour Temperature	2700 K → 6000 K
Light source replacable	Yes			A	10cm
Luminaire light beam	180°			B	60cm
				Custom Dimensions	On request

CHL 033

ROSA



Product	
Code	CHL 033
Name	ROSA
Categories	General
Subcategory	Modern
	Decorative
Type	Wall lamp
Finishing	On request

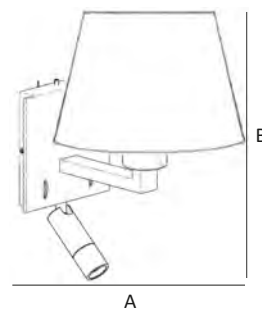

Product Specifications		General Information		Lamp Specifications & Dimensions	
Product Code	CHL 033	Suspension System	1 wire set	Lamp Holder	E14 + Power LED
Body	Metal	Protection	IP40	Type	LED
Number of light source	2	Installation	Indoor	Luminous Flux	80 lm/W + 100lm/W
Light source color	2700 K → 6000 K	Mourting	Wall mounted	Power	6W + 3W
Cap-Base	6cm	Warranty Period	2 years	Colour Temperature	2700 K → 6000 K
Light source replacable	Yes			A	27cm
Luminaire light beam	180°			B	40cm
				Custom Dimensions	On request



CHL 034

FERRIS

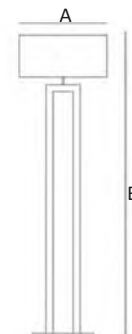

Product	
Code	CHL 034
Name	FERRIS
Categories	General
Subcategory	Modern
	Decorative
Type	Floor lamp
Finishing	RAL on request

Product Specifications		General Information		Lamp Specifications & Dimensions	
Product Code	CHL 034	Suspension System	N/A	Lamp Holder	E27
Body	Metal	Protection	IP40	Type	LED
Number of light source	1	Installation	Indoor	Luminous Flux	80 lm/W
Light source color	2700 K → 6000 K	Mounting	Stand alone	Power	10W
Cap-Base	N/A	Warranty Period	2 years	Colour Temperature	2700 K → 6000 K
Light source replacable	Yes			A	50cm
Luminaire light beam	180°			B	175cm
				Custom Dimensions	On request

KLA 001

SILENT

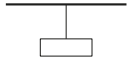

Product	
Code	KLA 001
Name	SILENT
Categories	General
Subcategory	Modern
	Decorative
Type	Pendant
Finishing	RAL on request

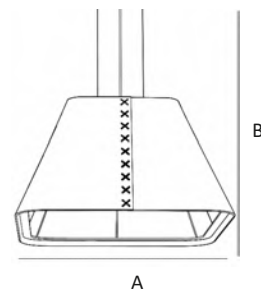

Product Specifications		General Information		Lamp Specifications & Dimensions	
Product Code	KLA 001	Suspension System	2 wire set	Lamp Holder	E27
Body	Metal	Protection	IP40	Type	LED
Number of light source	1	Installation	Indoor	Luminous Flux	80 lm/W
Light source color	2700 K → 6000 K	Mounting	Pendant	Power	10W
Cap-Base	10cm	Shade	Felt	Colour Temperature	2700 K → 6000 K
Light source replacable	Yes	Warranty Period	2 years	A	80x80cm
Luminaire light beam	180°			B	150cm
				Custom Dimensions	On request

KLA 002

TOWER

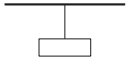

Product	
Code	KLA 002
Name	TOWER
Categories	General
Subcategory	Modern
	Decorative
Type	Pendant
Finishing	RAL on request

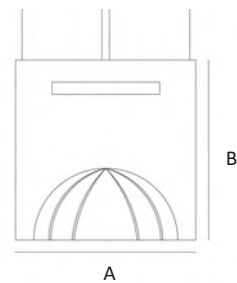

Product Specifications		General Information		Lamp Specifications & Dimensions	
Product Code	KLA 002	Suspension System	2 wire set	Lamp Holder	LED
Body	Metal	Protection	IP40	Type	SAMSUNG
Number of light source	1	Installation	Indoor	Luminous Flux	110 lm/W
Light source color	2700 K → 6000 K	Mounting	Pendant	Power	25W
Cap-Base	10cm	Shade	Felt	Colour Temperature	2700 K → 6000 K
Light source replacable	Yes	Warranty Period	2 years	A	55cm
Luminaire light beam	180°			B	80cm
				Custom Dimensions	On request

KLA 003

UFO

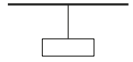

Product	
Code	KLA 003
Name	UFO
Categories	General
Subcategory	Modern
	Decorative
Type	Pendant
Finishing	RAL on request

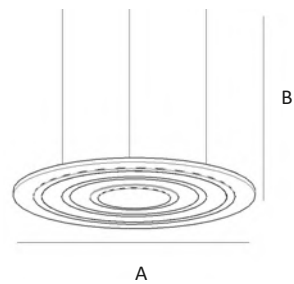

Product Specifications		General Information		Lamp Specifications & Dimensions	
Product Code	KLA 003	Suspension System	3 wire set	Lamp Holder	LED
Body	Metal	Protection	IP40	Type	SMD
Number of light source	1	Installation	Indoor	Luminous Flux	90 lm/W
Light source color	2700 K -> 6000 K	Mounting	Pendant	Power	18W
Cap-Base	15cm	Shade	Felt	Colour Temperature	2700 K -> 6000 K
Light source replacable	Yes	Warranty Period	2 years	A	80cm
Luminaire light beam	180°			B	150cm
				Custom Dimensions	On request

KLA 004

TALL

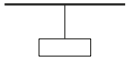

Product	
Code	KLA 004
Name	TALL
Categories	General
Subcategory	Modern
	Decorative
Type	Pendant
Finishing	RAL on request

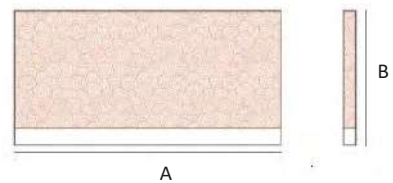

Product Specifications		General Information		Lamp Specifications & Dimensions	
Product Code	KLA 004	Suspension System	2 wire set	Lamp Holder	LED
Body	Metal	Protection	IP40	Type	SAMSUNG
Number of light source	1	Installation	Indoor	Luminous Flux	100lm/W
Light source color	2700 K → 6000 K	Mounting	Pendant	Power	15W
Cap-Base	15cm	Shade	Felt	Colour Temperature	2700 K → 6000 K
Light source replacable	Yes	Warranty Period	2 years	A	100cm
Luminaire light beam	180°			B	40cm
				Custom Dimensions	On request

KLA 005

SIRI



Product	
Code	KLA 005
Name	SIRI
Categories	General
Subcategory	Contemporary
	Decorative
Type	Pendant
Finishing	On request

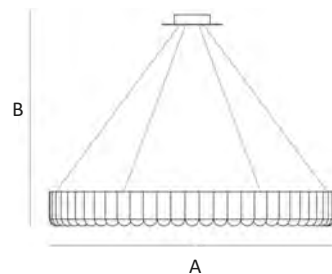

Product Specifications		General Information		Lamp Specifications & Dimensions	
Product Code	KLA 005	Suspension System	4 wire set	Lamp Holder	E27
Body	Metal	Protection	IP40	Type	LED
Number of light source	63	Installation	Indoor	Luminous Flux	80 lm/W
Light source color	2700 K -> 6000 K	Mourting	Pendant	Power	63x6W
Cap-Base	6cm	Warranty Period	2 years	Colour Temperature	2700 K -> 6000 K
Light source replacable	Yes			A	120cm
Luminaire light beam	180°			B	150cm
				Custom Dimensions	On request

KLA 006

REFINE



Product	
Code	KLA 006
Name	REFINE
Categories	General
Subcategory	Contemporary
	Decorative
Type	Pendant
Finishing	On request

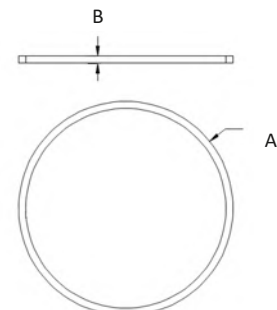

Product Specifications		General Information		Lamp Specifications & Dimensions	
Product Code	KLA 006	Suspension System	3 wire set	Lamp Holder	LED
Body	Aluminum	Protection	IP40	Type	SAMSUNG
Number of light source	1	Installation	Indoor	Luminous Flux	110 lm/W
Light source color	2700 K → 6000 K	Mounrting	Pendant	Power	30W
Cap-Base	22cm	Warranty Period	2 years	Colour Temperature	2700 K → 6000 K
Light source replacable	Yes			A	100cm
Luminaire light beam	180°			B	2.5cm
				Custom Dimensions	On request

KLA 007

ALBA C



Product	
Code	KLA 007
Name	ALBA C
Categories	General
Subcategory	Contemporary
	Decorative
Type	Pendant
Finishing	On request

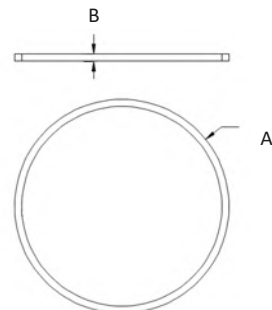

Product Specifications	General Information		Lamp Specifications & Dimensions		
Product Code	KLA 007	Suspension System	3 wire set	Lamp Holder	LED
Body	Aluminum	Protection	IP40	Type	SAMSUNG
Number of light source	1	Installation	Indoor	Luminous Flux	110 lm/W
Light source color	2700 K → 6000 K	Mounrting	Pendant	Power	60W
Cap-Base	22cm	Warranty Period	2 years	Colour Temperature	2700 K → 6000 K
Light source replacable	Yes			A	100cm
Luminaire light beam	180°			B	6.1cm
				Custom Dimensions	On request

KLA 008

ALBA W



Product	
Code	KLA 008
Name	ALBA W
Categories	General
Subcategory	Contemporary
	Decorative
Type	Pendant
Finishing	On request

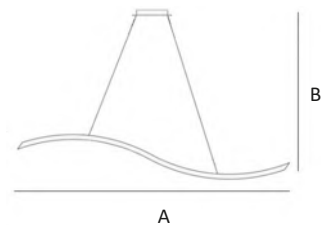

Product Specifications		General Information		Lamp Specifications & Dimensions	
Product Code	KLA 008	Suspension System	2 wire set	Lamp Holder	LED
Body	Aluminum	Protection	IP40	Type	SAMSUNG
Number of light source	1	Installation	Indoor	Luminous Flux	110 lm/W
Light source color	2700 K → 6000 K	Mounting	Pendant	Power	40W
Cap-Base	22cm	Warranty Period	2 years	Colour Temperature	2700 K → 6000 K
Light source replacable	Yes			A	150cm
Luminaire light beam	180°			B	150cm
				Custom Dimensions	On request

KLA 009

SKY

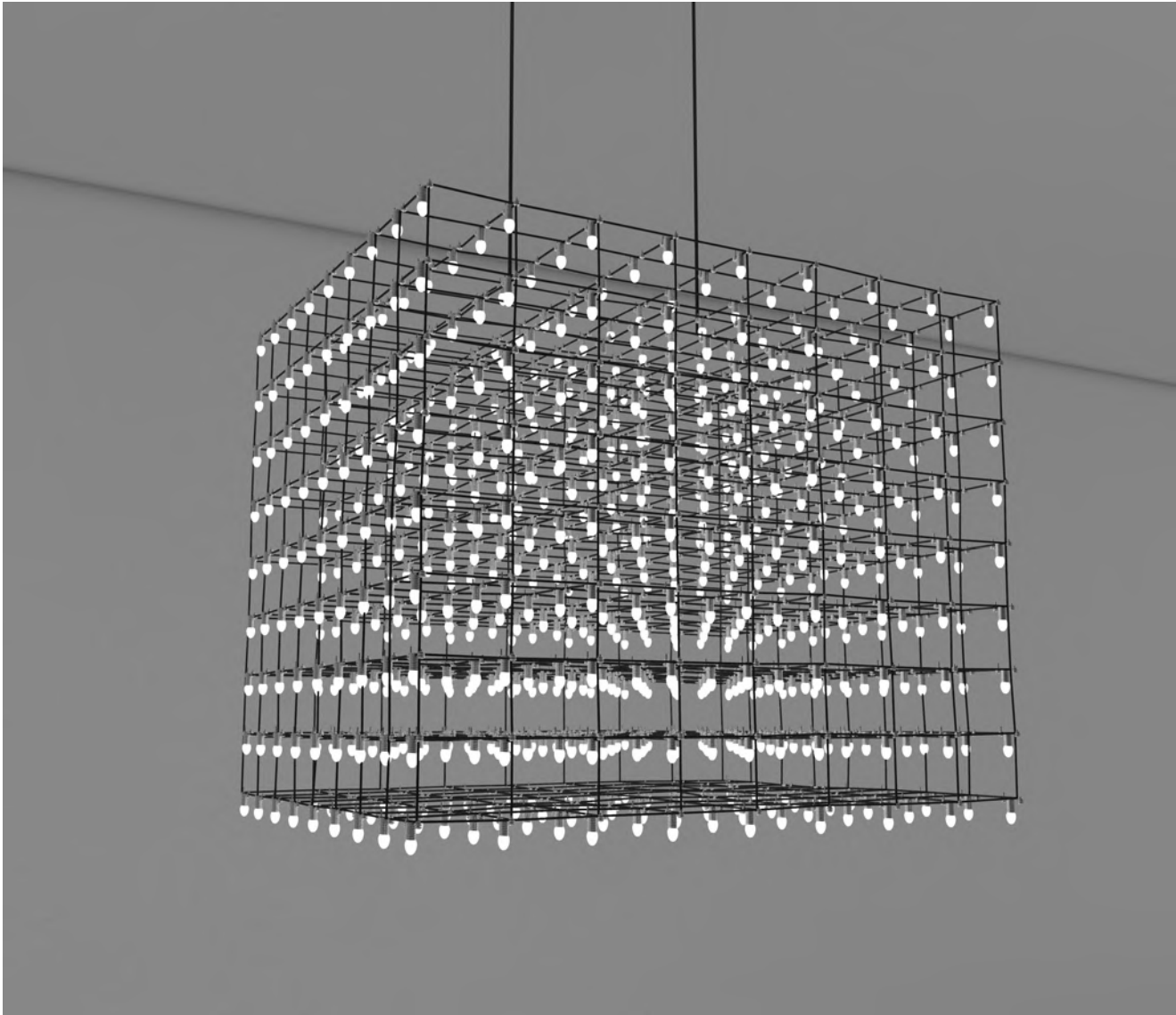

Product	
Code	KLA 009
Name	SKY
Categories	General
Subcategory	Contemporary
	Decorative
Type	Pendant
Finishing	RAL on request

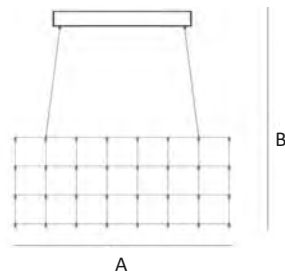

Product Specifications		General Information		Lamp Specifications & Dimensions	
Product Code	KLA 009	Suspension System	4 wire set	Lamp Holder	E10
Body	Metal	Protection	IP40	Type	LED
Number of light source	260	Installation	Indoor	Luminous Flux	30 lm/W
Light source color	2700 K → 6000 K	Mounting	Pendant	Power	260x0.3W
Cap-Base	N/A	Warranty Period	2 years	Colour Temperature	2700 K → 6000 K
Light source replacable	Yes			A	104cm
Luminaire light beam	180°			B	200cm
				Custom Dimensions	On request

KLA 010

NATURE

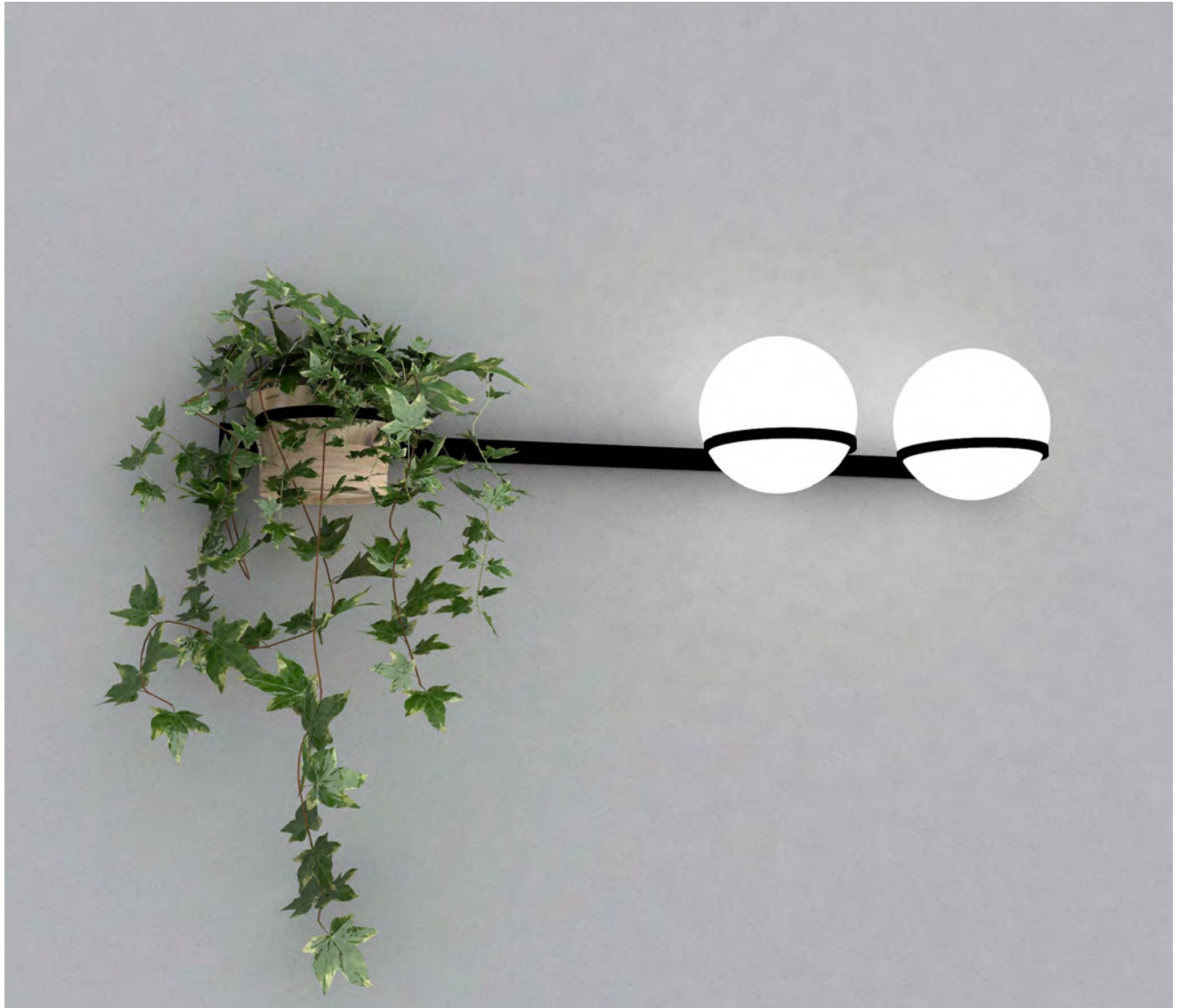

Product	
Code	KLA 010
Name	NATURE
Categories	General
Subcategory	Contemporary
	Decorative
Type	Wall lamp
Finishing	RAL on request

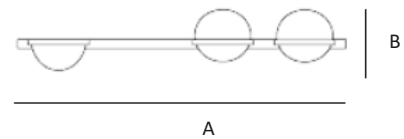

Product Specifications		General Information		Lamp Specifications & Dimensions	
Product Code	KLA 010	Suspension System	N/A	Lamp Holder	E27
Body	Metal	Protection	IP40	Type	LED
Number of light source	2	Installation	Indoor	Luminous Flux	80lm/W
Light source color	2700 K → 6000 K	Mounting	Wall mounted	Power	2x10W
Cap-Base	N/A	Warranty Period	2 years	Colour Temperature	2700 K → 6000 K
Light source replacable	Yes			A	150cm
Luminaire light beam	180°			B	45cm
				Custom Dimensions	On request

KLA 011

TUBO



Product	
Code	KLA 011
Name	TUBO
Categories	General
Subcategory	Contemporary
	Decorative
Type	Pendant
Finishing	RAL on request



Product Specifications		General Information		Lamp Specifications & Dimensions	
Product Code	KLA 011	Suspension System	1 Wire set	Lamp Holder	LED
Body	Metal	Protection	IP40	Type	COB
Number of light source	1	Installation	Indoor	Luminous Flux	120lm/W
Light source color	2700 K -> 6000 K	Mounting	Pendant	Power	1x10W
Cap-Base	N/A	Diffuser	Glass	Colour Temperature	2700 K -> 6000 K
Light source replacable	Yes	Warranty Period	2 years	A	70cm
Luminaire light beam	180°			B	5cm
				Custom Dimensions	On request

KLA 012

PUZZLE

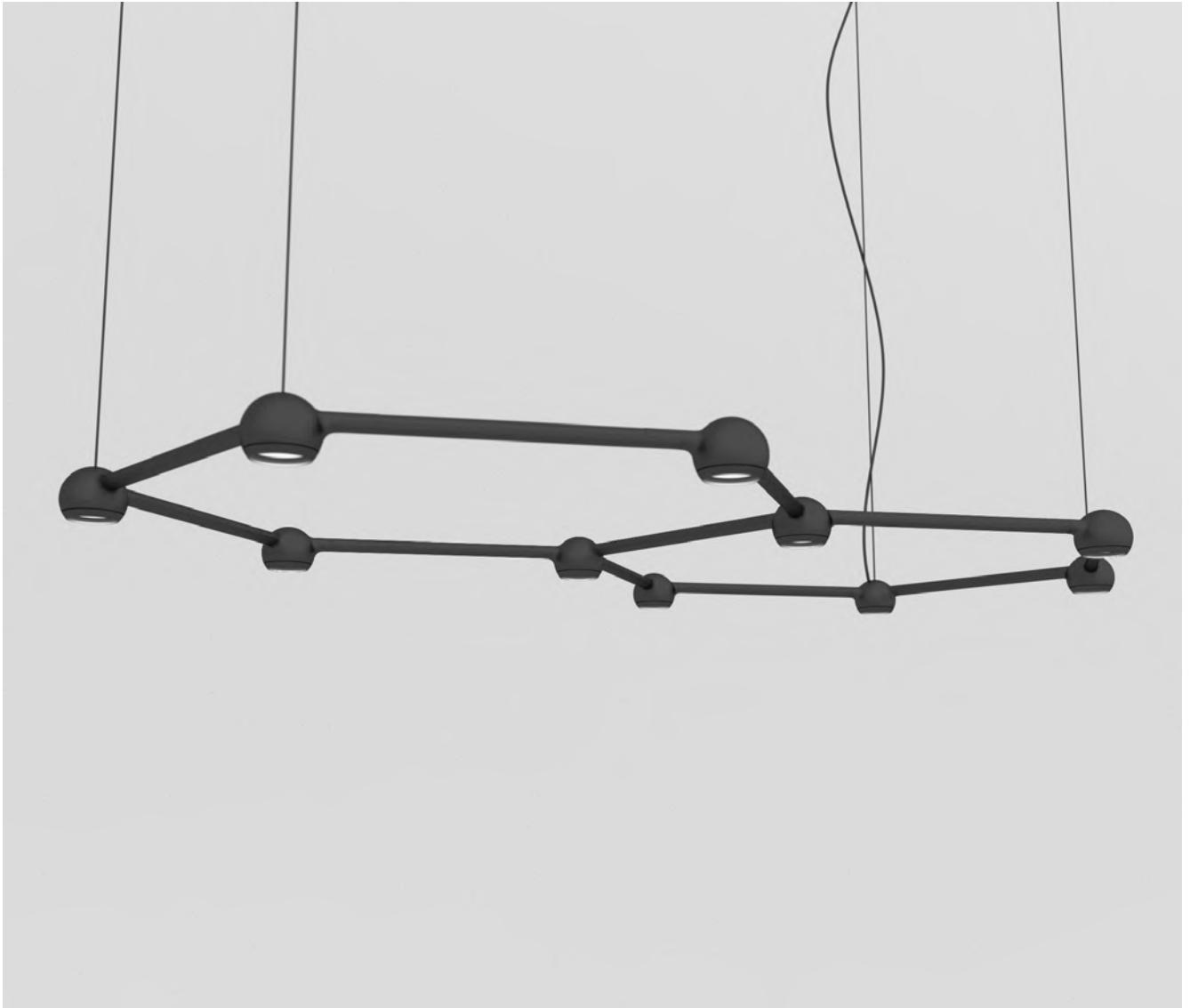

Product	
Code	KLA 012
Name	PUZZLE
Categories	General
Subcategory	Contemporary
	Decorative
Type	Pendant
Finishing	RAL on request

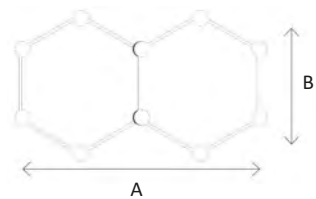

Product Specifications		General Information		Lamp Specifications & Dimensions	
Product Code	KLA 012	Suspension System	4 wire set	Lamp Holder	GU10
Body	Metal	Protection	IP40	Type	LED
Number of light source	10	Installation	Indoor	Luminous Flux	80lm/W
Light source color	2700 K -> 6000 K	Mounting	Pendant	Power	10x5W
Cap-Base	N/A	Warranty Period	2 years	Colour Temperature	2700 K -> 6000 K
Light source replacable	Yes			A	160cm
Luminaire light beam	180°			B	80cm
				Custom Dimensions	On request

KLA 013

DISCUS



Product	
Code	KLA 013
Name	DISCUS
Categories	General
Subcategory	Contemporary Decorative
Type	Pendant
Finishing	On request

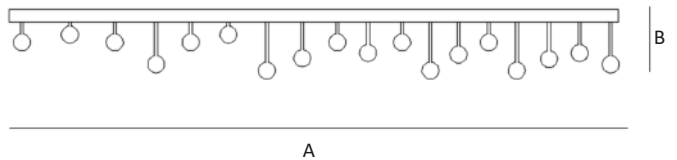

Product Specifications		General Information		Lamp Specifications & Dimensions	
Product Code	KLA 013	Suspension System	3 wire set	Lamp Holder	LED
Body	Metal	Protection	IP40	Type	SAMSUNG
Number of light source	1	Installation	Indoor	Luminous Flux	10 lm/W
Light source color	2700 K → 6000 K	Mounrting	Pendant	Power	20W
Cap-Base	22cm	Warranty Period	2 years	Colour Temperature	2700 K → 6000 K
Light source replacable	Yes			A	100cm
Luminaire light beam	180°			B	30cm
				Custom Dimensions	On request

KLA 014

STRATUS

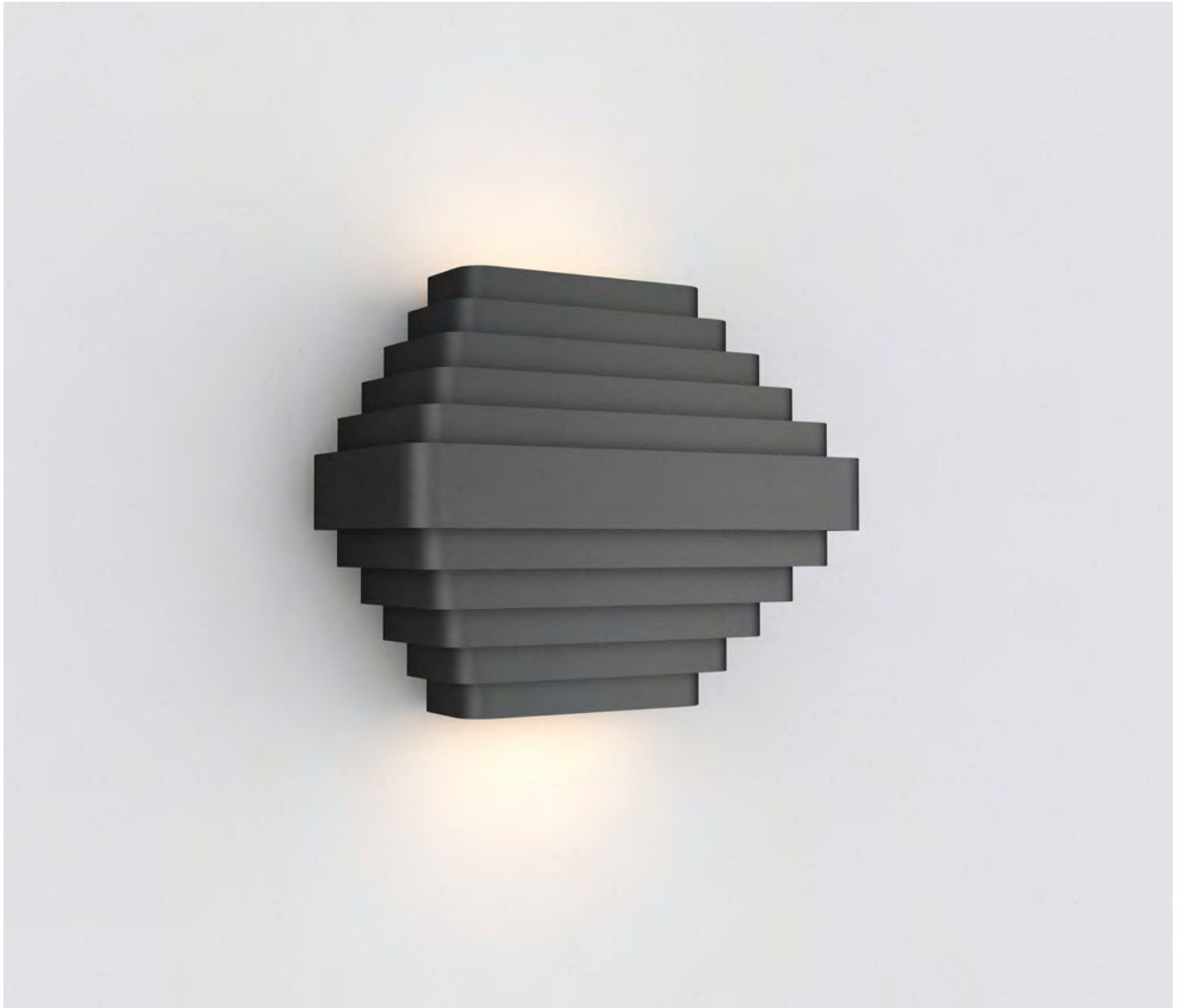

Product	
Code	KLA 014
Name	STRATUS
Categories	General
Subcategory	Contemporary
	Decorative
Type	Wall lamp
Finishing	RAL on request

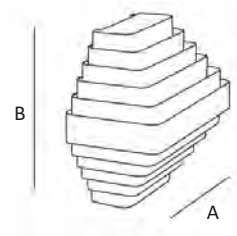

Product Specifications		General Information		Lamp Specifications & Dimensions	
Product Code	MLA 014	Suspension System	N/A	Lamp Holder	E27
Body	Metal	Protection	IP40	Type	LED
Number of light source	1	Installation	Indoor	Luminous Flux	80 lm/W
Light source color	2700 K → 6000 K	Mounting	Wall mounted	Power	6W
Cap-Base	N/A	Warranty Period	2 years	Colour Temperature	2700 K → 6000 K
Light source replaceable	Yes			A	40cm
Luminaire light beam	180°			B	35cm
				Custom Dimensions	On request

TLL 001

DATA S1



Product	
Code	TLL 001
Name	DATA S1
Categories	General
Subcategory	Architectural
Type	Pendant
Finishing	On request



Product Specifications		General Information		Lamp Specifications & Dimensions	
Product Code	TLL 001	Suspension System	1 wire set	Lamp Holder	LED
Body	Metal	Protection	IP40	Type	Power LED
Number of light source	1	Installation	indoor	Luminous Flux	100 lm/W
Light source color	2700 K -> 6000 K	Mounting	Pendant	Power	3W
Cap-Base	10cm	Warranty Period	2 years	Colour Temperature	2700 K -> 6000 K
Light source replacable	Yes			A	3cm
Luminaire light beam	180°			B	150cm
				Custom Dimensions	On request

TLL 002

DATA S2



Product	
Code	TLL 002
Name	DATA S2
Categories	General
Subcategory	Architectural
Type	Pendant
Finishing	RAL on request



Product Specifications		General Information		Lamp Specifications & Dimensions	
Product Code	TLL 002	Suspension System	1 wire set	Lamp Holder	GU10
Body	Metal	Protection	IP40	Type	LED
Number of light source	1	Installation	Indoor	Luminous Flux	80 lm/W
Light source color	2700 K -> 6000 K	Mounting	Pendant	Power	6W
Cap-Base	N/A	Warranty Period	2 years	Colour Temperature	2700 K -> 6000 K
Light source replacable	Yes			A	6cm
Luminaire light beam	180°			B	150cm
				Custom Dimensions	On request

TLL 003

DATA S3



Product	
Code	TLL 003
Name	DATA S3
Categories	General
Subcategory	Architectural
Type	Pendant
Finishing	On request



Product Specifications		General Information		Lamp Specifications & Dimensions	
Product Code	TLL 003	Suspension System	1 wire set	Lamp Holder	PAR30
Body	Metal	Protection	IP40	Type	LED
Number of light source	1	Installation	Indoor	Luminous Flux	80 lm/W
Light source color	2700 K → 6000 K	Mounrtng	Pendant	Power	10W
Cap-Base	6cm	Warranty Period	2 years	Colour Temperature	2700 K → 6000 K
Light source replacable	Yes			A	11cm
Luminaire light beam	180°			B	150cm
				Custom Dimensions	On request

TLL 004

DATA C



Product	
Code	TLL 004
Name	DATA C
Categories	General
Subcategory	Architectural
Type	Ceiling lamp
Finishing	RAL on request

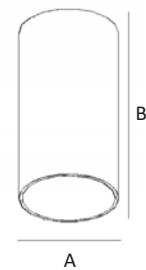

Product Specifications		General Information		Lamp Specifications & Dimensions	
Product Code	TLL 004	Suspension System	N/A	Lamp Holder	GU10
Body	Metal	Protection	IP40	Type	LED
Number of light source	2	Installation	Indoor	Luminous Flux	80 lm/W
Light source color	2700 K → 6000 K	Mounting	Surface mounted	Power	6W
Cap-Base	N/A	Warranty Period	2 years	Colour Temperature	2700 K → 6000 K
Light source replacable	Yes			A	6cm
Luminaire light beam	180°			B	20cm
				Custom Dimensions	On request

TLL 005

ADO S1

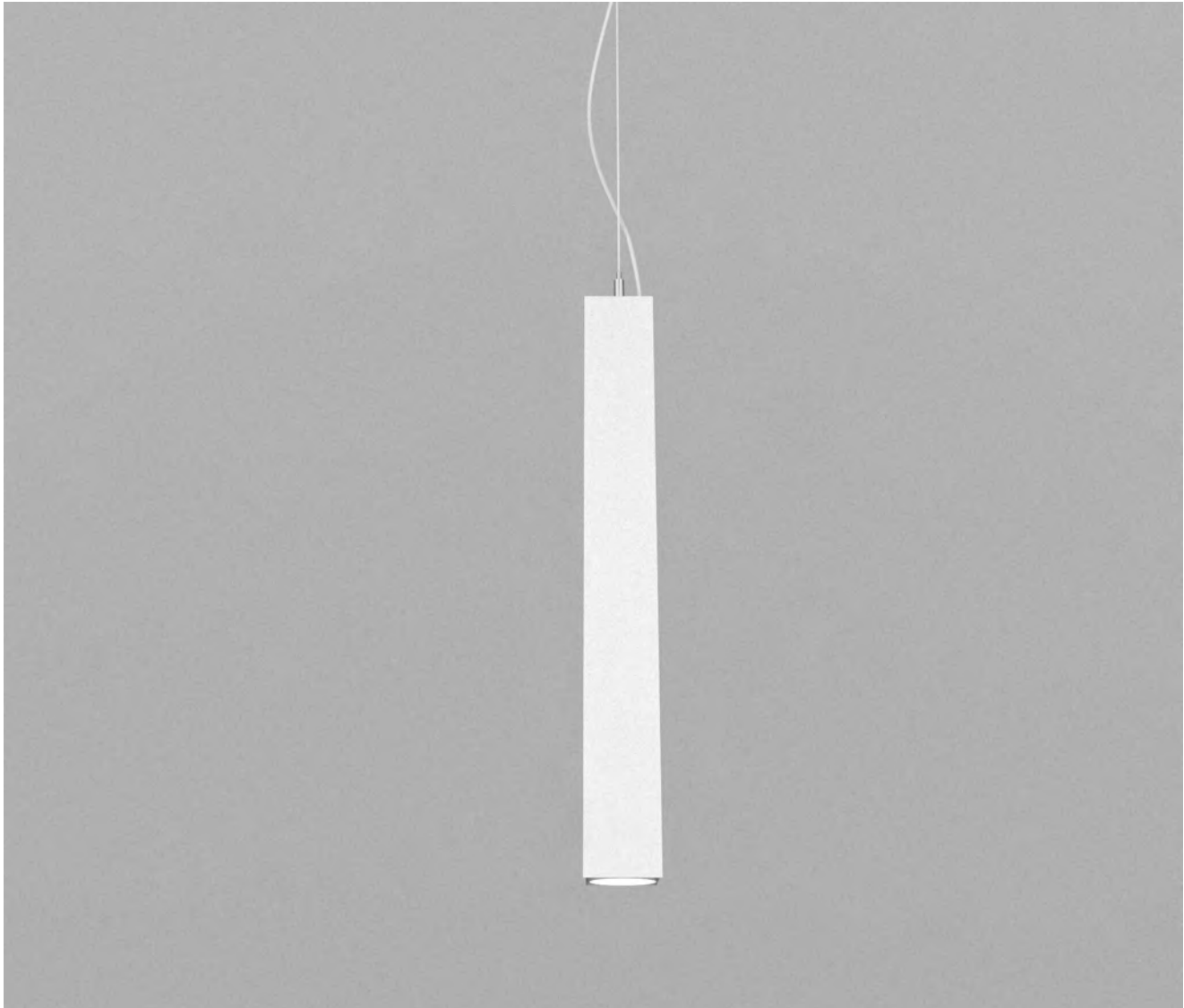

Product	
Code	TLL 005
Name	ADO S1
Categories	General
Subcategory	Architectural
Type	Pendant
Finishing	On request

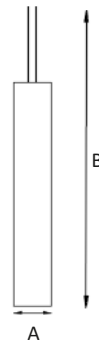

Product Specifications		General Information		Lamp Specifications & Dimensions	
Product Code	TLL 005	Suspension System	1 wire set	Lamp Holder	GU10
Body	Metal	Protection	IP40	Type	LED
Number of light source	1	Installation	Indoor	Luminous Flux	80 lm/W
Light source color	2700 K -> 6000 K	Mournting	Pendant	Power	6W
Cap-Base	6cm	Warranty Period	2 years	Colour Temperature	2700 K -> 6000 K
Light source replacable	Yes			A	6x6cm
Luminaire light beam	180°			B	150cm
				Custom Dimensions	On request

TLL 006

ADO S2

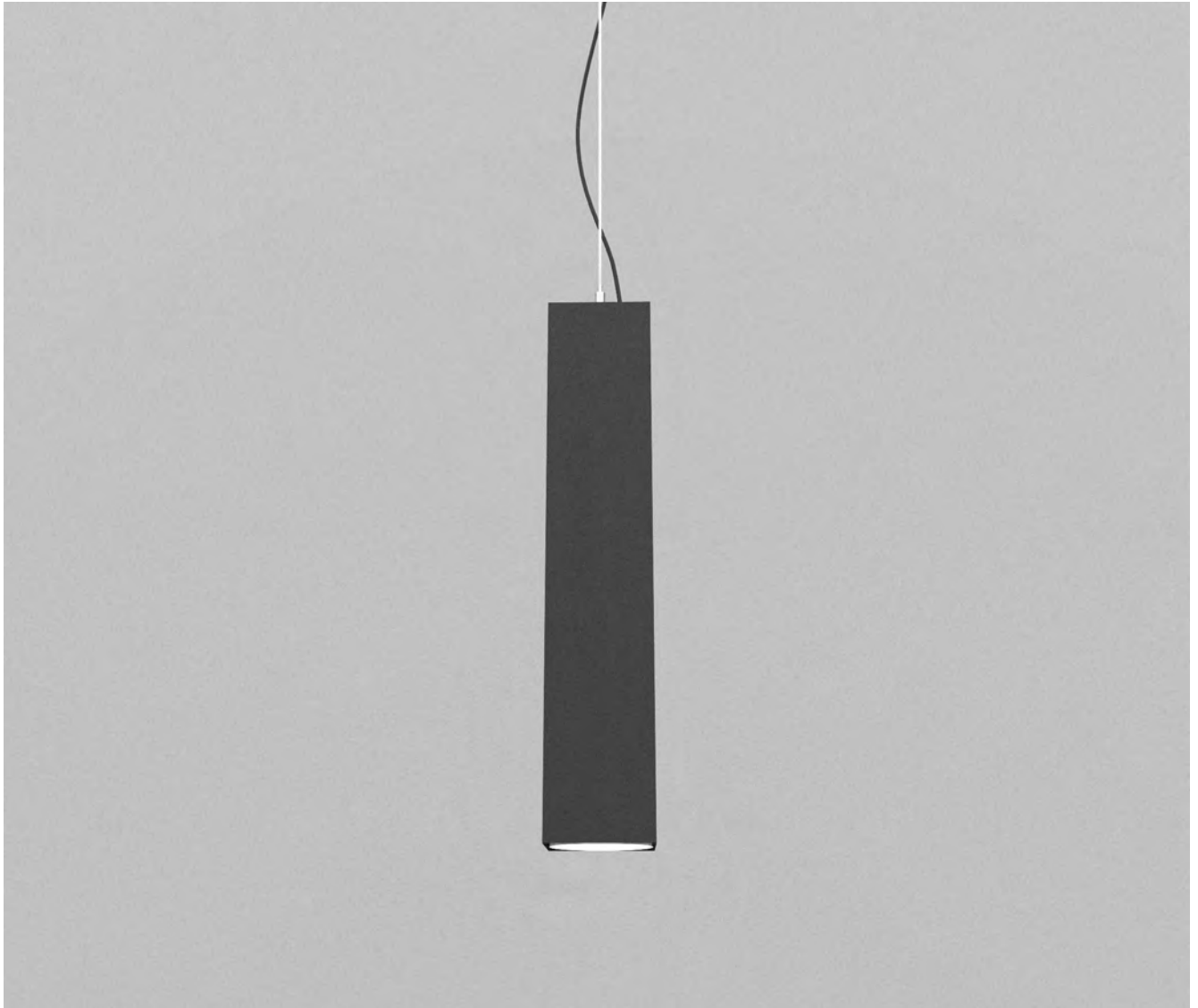

Product	
Code	TLL 006
Name	ADO S2
Categories	General
Subcategory	Architectural
Type	Pendant
Finishing	RAL on request



Product Specifications		General Information		Lamp Specifications & Dimensions	
Product Code	TLL 006	Suspension System	1 wire set	Lamp Holder	PAR30
Body	Metal	Protection	IP40	Type	LED
Number of light source	1	Installation	Indoor	Luminous Flux	80 lm/W
Light source color	2700 K → 6000 K	Mounting	Pendant	Power	10W
Cap-Base	6cm	Warranty Period	2 years	Colour Temperature	2700 K → 6000 K
Light source replacable	Yes			A	11x11cm
Luminaire light beam	180°			B	150cm
				Custom Dimensions	On request

TLL 007

HEXAGON



Product	
Code	TLL 007
Name	HEXAGON
Categories	General
Subcategory	Architectural
Type	Pendant
Finishing	On request



Product Specifications		General Information		Lamp Specifications & Dimensions	
Product Code	TLL 007	Suspension System	1 wire set	Lamp Holder	GU10
Body	Metal	Protection	IP40	Type	LED
Number of light source	1	Installation	Indoor	Luminous Flux	80 lm/W
Light source color	2700 K -> 6000 K	Mounting	Pendant	Power	6W
Cap-Base	6cm	Warranty Period	2 years	Colour Temperature	2700 K -> 6000 K
Light source replacable	Yes			A	7cm
Luminaire light beam	180°			B	150cm
				Custom Dimensions	On request

TLL 008

DARK



Product	
Code	TLL 008
Name	DARK
Categories	General
Subcategory	Architectural
Type	Recessed
Finishing	RAL on request

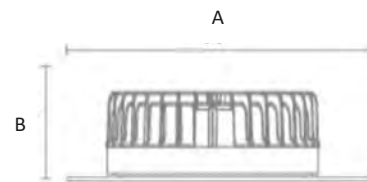

Product Specifications		General Information		Lamp Specifications & Dimensions	
Product Code	TLL 008	Suspension System	N/A	Lamp Holder	LED
Body	Metal	Protection	IP40	Type	SMD
Number of light source	1	Installation	Indoor	Luminous Flux	100 lm/W
Light source color	2700 K → 6000 K	Mounting	Ceiling recessed	Power	10W
Cap-Base	N/A	Warranty Period	2 years	Colour Temperature	2700 K → 6000 K
Light source replacable	Yes			A	10x10cm
Luminaire light beam	180°			B	7cm
				Custom Dimensions	On request

TLL 009

CONE

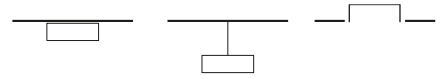

Product	
Code	TLL 009
Name	CONE
Categories	General
Subcategory	Architectural
Type	Track light
Finishing	On request

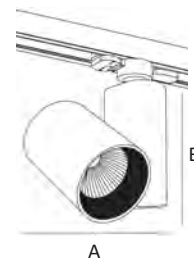

Product Specifications		General Information		Lamp Specifications & Dimensions	
Product Code	TLL 009	Suspension System	N/A	Lamp Holder	LED
Body	Metal	Protection	IP40	Type	COB
Number of light source	1	Installation	Indoor	Luminous Flux	120 lm/W
Light source color	2700 K → 6000 K	Mournting	Track mounted	Power	20W
Cap-Base	N/A	Warranty Period	2 years	Colour Temperature	2700 K → 6000 K
Light source replacable	Yes			A	10cm
Luminaire light beam	180°			B	13cm
				Custom Dimensions	On request

TLL 010

HEAT

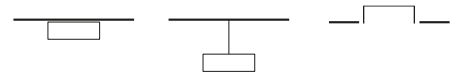

Product	
Code	TLL 010
Name	HEAT
Categories	General
Subcategory	Architectural
Type	Track light
Finishing	RAL on request

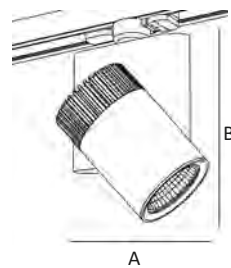

Product Specifications		General Information		Lamp Specifications & Dimensions	
Product Code	TLL 010	Suspension System	N/A	Lamp Holder	LED
Body	Metal	Protection	IP40	Type	COB
Number of light source	2	Installation	Indoor	Luminous Flux	120 lm/W
Light source color	2700 K -> 6000 K	Mounting	Track mounted	Power	15W
Cap-Base	N/A	Warranty Period	2 years	Colour Temperature	2700 K -> 6000 K
Light source replacable	Yes			A	6cm
Luminaire light beam	180°			B	8cm
				Custom Dimensions	On request

TLL 011

FLASH

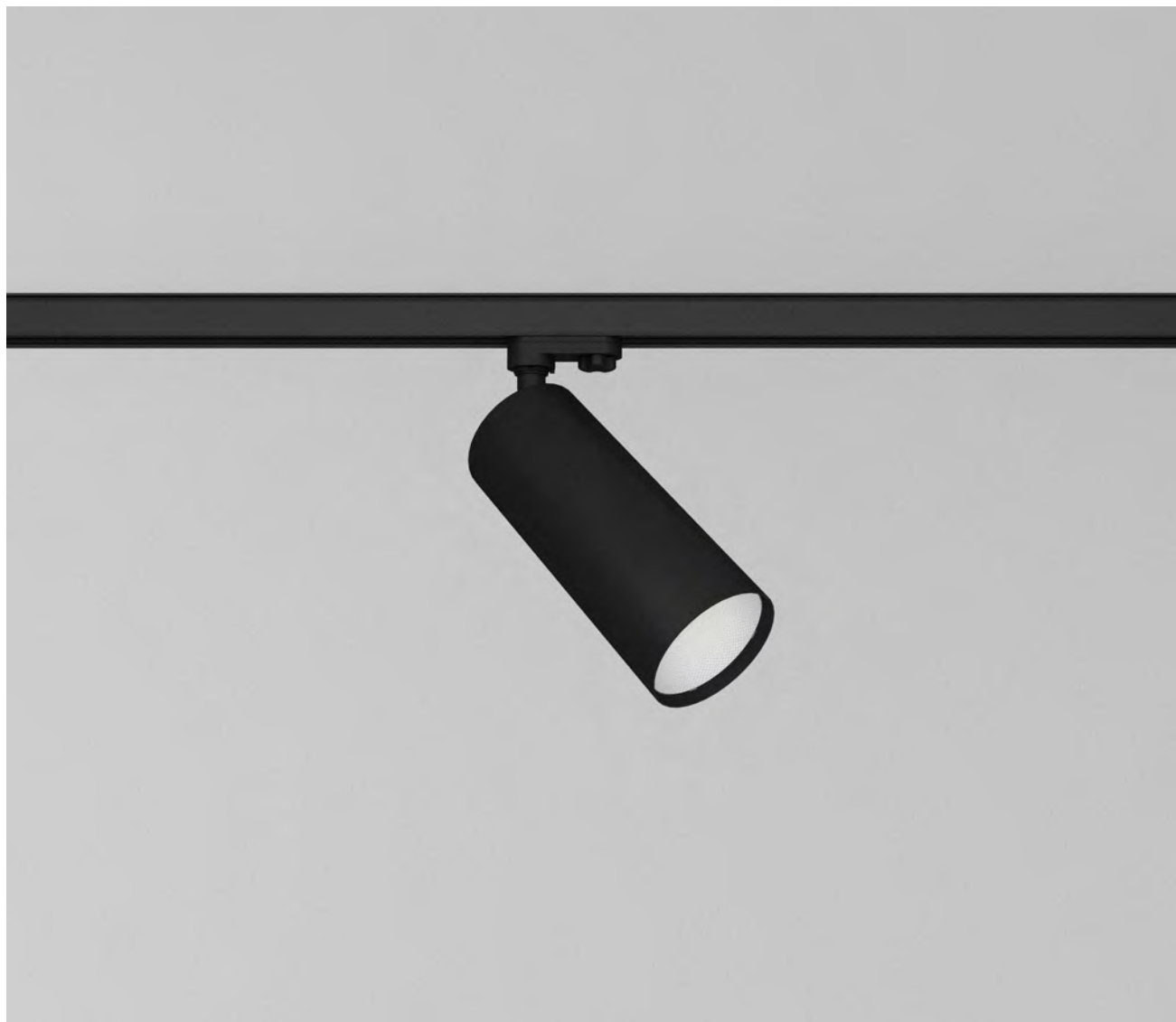
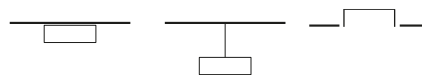

Product	
Code	TLL 011
Name	FLASH
Categories	General
Subcategory	Architectural
Type	Track light
Finishing	On request

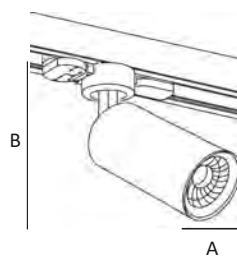

Product Specifications		General Information		Lamp Specifications & Dimensions	
Product Code	TLL 011	Suspension System	N/A	Lamp Holder	LED
Body	Metal	Protection	IP40	Type	COB
Number of light source	1	Installation	Indoor	Luminous Flux	120 lm/W
Light source color	2700 K -> 6000 K	Mounting	Track mounted	Power	10W
Cap-Base	N/A	Warranty Period	2 years	Colour Temperature	2700 K -> 6000 K
Light source replacable	Yes			A	6cm
Luminaire light beam	180°			B	15cm
				Custom Dimensions	On request

TLL 012

EASY SQ



Product	
Code	TLL 012
Name	EASY SQ
Categories	General
Subcategory	Architectural
Type	Ceiling lamp
Finishing	RAL on request

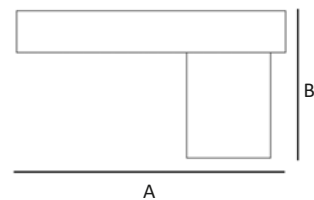

Product Specifications		General Information		Lamp Specifications & Dimensions	
Product Code	TLL 012	Suspension System	N/A	Lamp Holder	GU10
Body	Metal	Protection	IP40	Type	LED
Number of light source	1	Installation	Indoor	Luminous Flux	80 lm/W
Light source color	2700 K → 6000 K	Mounting	Surface mounted	Power	6W
Cap-Base	N/A	Warranty Period	2 years	Colour Temperature	2700 K → 6000 K
Light source replacable	Yes			A	20cm
Luminaire light beam	180°			B	15cm
				Custom Dimensions	On request

TLL 013

EASY S



Product	
Code	TLL 013
Name	EASY S
Categories	General
Subcategory	Architectural
Type	Ceiling lamp
Finishing	On request

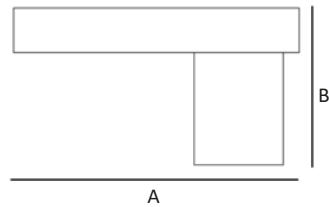

Product Specifications		General Information		Lamp Specifications & Dimensions	
Product Code	TLL 013	Suspension System	N/A	Lamp Holder	GU10
Body	Metal	Protection	IP40	Type	LED
Number of light source	1	Installation	Indoor	Luminous Flux	80 lm/W
Light source color	2700 K → 6000 K	Mounting	Surface mounted	Power	6W
Cap-Base	N/A	Warranty Period	2 years	Colour Temperature	2700 K → 6000 K
Light source replacable	Yes			A	20cm
Luminaire light beam	180°			B	15cm
				Custom Dimensions	On request

TLL 014

EASY D



Product	
Code	TLL 014
Name	EASY D
Categories	General
Subcategory	Architectural
Type	Ceiling lamp
Finishing	RAL on request

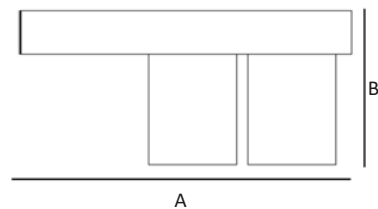

Product Specifications		General Information		Lamp Specifications & Dimensions	
Product Code	TLL 014	Suspension System	N/A	Lamp Holder	GU10
Body	Metal	Protection	IP40	Type	LED
Number of light source	2	Installation	Indoor	Luminous Flux	80 lm/W
Light source color	2700 K → 6000 K	Mounting	Surface mounted	Power	2x6W
Cap-Base	N/A	Warranty Period	2 years	Colour Temperature	2700 K → 6000 K
Light source replacable	Yes			A	20cm
Luminaire light beam	180°			B	15cm
				Custom Dimensions	On request

TLL 015

UP DOWN

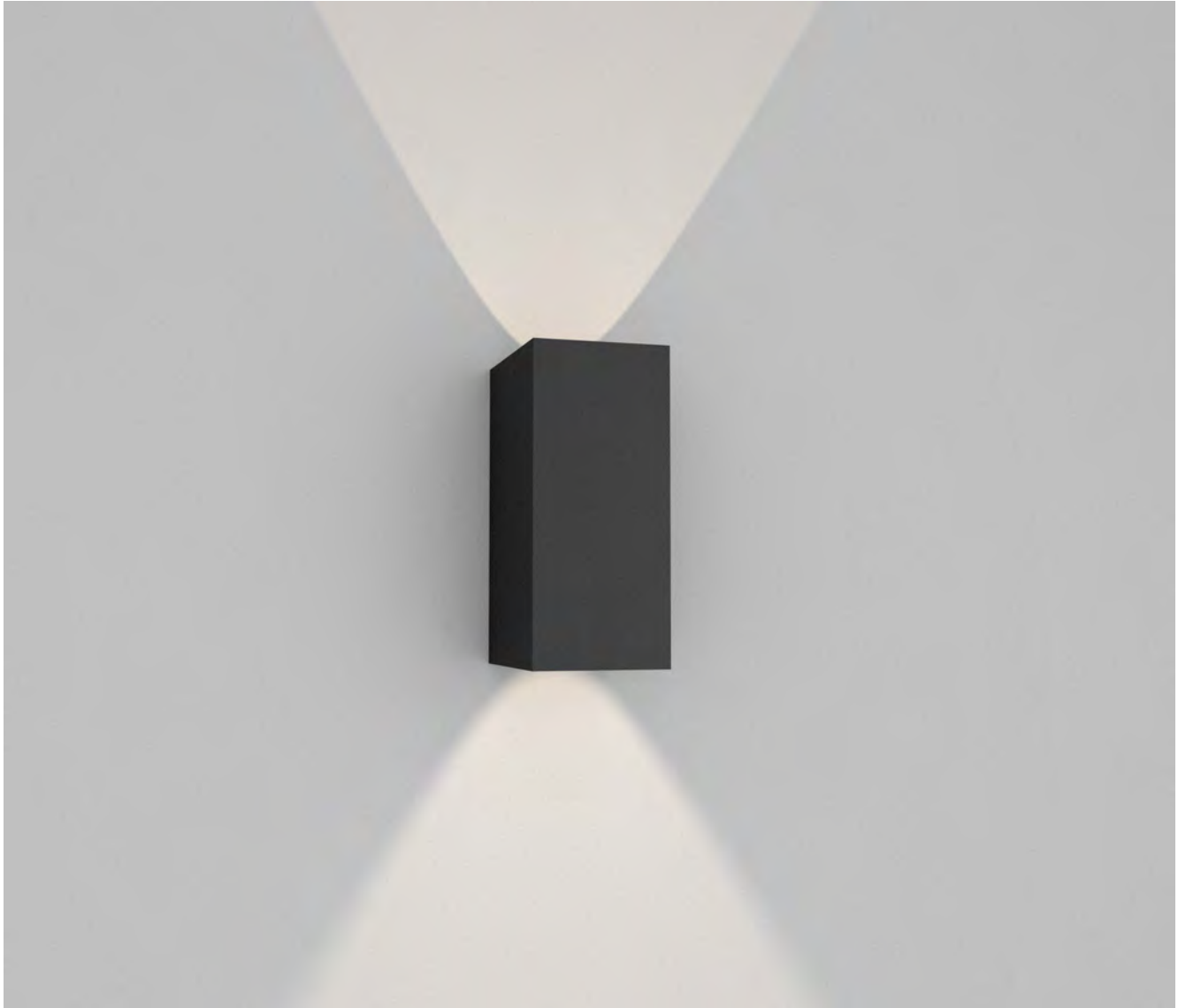

Product	
Code	TLL 015
Name	UP DOWN
Categories	General
Subcategory	Architectural
Type	Wall lamp
Finishing	On request

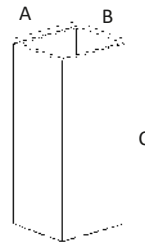

Product Specifications		General Information		Lamp Specifications & Dimensions	
Product Code	TLL 015	Suspension System	N/A	Lamp Holder	GU10
Body	Metal	Protection	IP40	Type	LED
Number of light source	2	Installation	Indoor	Luminous Flux	80 lm/W
Light source color	2700 K → 6000 K	Mounting	Wall mounted	Power	2x6W
Cap-Base	N/A	Warranty Period	2 years	Colour Temperature	2700 K → 6000 K
Light source replacable	Yes			A	10cm
Luminaire light beam	180°			B	10cm
				C	15cm

TLL 016

SLIDE



Product	
Code	TLL 016
Name	SLIDE
Categories	General
Subcategory	Architectural
Type	Wall lamp
Finishing	RAL on request



Product Specifications		General Information		Lamp Specifications & Dimensions	
Product Code	TLL 016	Suspension System	N/A	Lamp Holder	GU10
Body	Metal	Protection	IP40	Type	LED
Number of light source	1	Installation	Indoor	Luminous Flux	80 lm/W
Light source color	2700 K → 6000 K	Mounting	Wall lamp	Power	6W
Cap-Base	N/A	Warranty Period	2 years	Colour Temperature	2700 K → 6000 K
Light source replacable	Yes			A	12cm
Luminaire light beam	180°			B	16cm
				Custom Dimensions	On request

TLL 017

ZIPP



Product	
Code	TLL 017
Name	ZIPP
Categories	General
Subcategory	Architectural
Type	Wall lamp
Finishing	On request

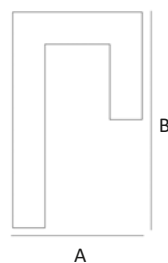

Product Specifications		General Information		Lamp Specifications & Dimensions	
Product Code	TLL 017	Suspension System	N/A	Lamp Holder	LED
Body	Metal	Protection	IP40	Type	SMD
Number of light source	1	Installation	Indoor	Luminous Flux	100 lm/W
Light source color	2700 K → 6000 K	Mournting	Wall mounted	Power	4W
Cap-Base	N/A	Warranty Period	2 years	Colour Temperature	2700 K → 6000 K
Light source replacable	Yes			A	15cm
Luminaire light beam	180°			B	26cm
				Custom Dimensions	On request

TLL 018

RECTA



Product	
Code	TLL 018
Name	RECTA
Categories	General
Subcategory	Architectural
Type	Wall lamp
Finishing	RAL on request

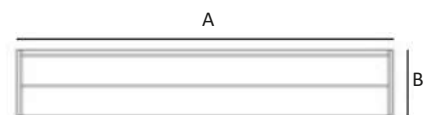

Product Specifications		General Information		Lamp Specifications & Dimensions	
Product Code	TLL 018	Suspension System	N/A	Lamp Holder	LED
Body	Metal	Protection	IP40	Type	SAMSUNG
Number of light source	1	Installation	Indoor	Luminous Flux	100 lm/W
Light source color	2700 K → 6000 K	Mounting	Wall mounted	Power	12W
Cap-Base	N/A	Warranty Period	2 years	Colour Temperature	2700 K → 6000 K
Light source replacable	Yes			A	60cm
Luminaire light beam	180°			B	12cm
				Custom Dimensions	On request

CERTIFICATES



CERTIFICATE

Attestation of Conformity

Name and Address of Certificate Holder: PROFİLİST LED AYDINLATMA SANAYİ VE TİCARET LİMİTED ŞİRKETİ Yakuplu Mah. 78. Sok. No:13A/A Beylikdüzü-İstanbul/TÜRKİYE	Certificate Number: SE-236-02
Name and Address of Manufacturer: PROFİLİST LED AYDINLATMA SANAYİ VE TİCARET LİMİTED ŞİRKETİ Yakuplu Mah. 78. Sok. No:13A/A Beylikdüzü-İstanbul/TÜRKİYE	Date of Issue: 30-11-2020
Brand: <div style="text-align: center;">  </div>	Expiration Date: 30-11-2021
Product Name: LED LIGHTING LUMINAIRE	Report Number: LVD-236-02
Model No: ANNEX 1	Page: 1 of 2
Test Required: EN 60598-2-1:1989 used in conjunction with EN 60598-1:2015/A1:2018	

The product meets the technical requirement of the above standards and hence fulfils the technical requirements of the following directives.

2014/35/EU LOW VOLTAGE DIRECTIVE

This certificate is only valid for the equipment and configuration described, in conjunction with the test data detailed above and with compliance with all applicable legal requirement for the product

The CE Mark as shown below can be used, under the responsibility of the manufacturer or the importer, after completion of an EC Declaration of Conformity and compliance with all relevant EC Directives.

SIGNATURE







GGS TEST HİZMETLERİ TEKNİK KONTROL VE BELGELENDİRME ANONİM ŞİRKETİ
 Kayışdağı Mah. Gülçin Sok. No:2/2 Ataşehir/İstanbul/TÜRKİYE



Sertifika

ISO 9001 : 2015

PROFİLİST LED AYDINLATMA SANAYİ VE TİCARET LİMİTED ŞİRKETİ
 Yakuplu Mah. 78. Sok. No:13A/A Beylikdüzü-İstanbul/TÜRKİYE

KAPSAM
 Aydınlatma ekipmanlarının üretim süreci (tasarım, üretim)

AS
 ACCREDITED
 ISO 9001:2015





Sertifika

ISO 14001 : 2015

PROFİLİST LED AYDINLATMA SANAYİ VE TİCARET LİMİTED ŞİRKETİ
 Yakuplu Mah. 78. Sok. No:13A/A Beylikdüzü-İstanbul/TÜRKİYE

KAPSAM
 Aydınlatma ekipmanlarının üretim süreci (tasarım, üretim)

AS
 ACCREDITED
 ISO 14001:2015





Sertifika

ISO 10002 : 2014

PROFİLİST LED AYDINLATMA SANAYİ VE TİCARET LİMİTED ŞİRKETİ
 Yakuplu Mah. 78. Sok. No:13A/A Beylikdüzü-İstanbul/TÜRKİYE

KAPSAM
 Aydınlatma ekipmanlarının üretim süreci (tasarım, üretim)

AS
 ACCREDITED
 ISO 10002:2014





Sertifika

OHSAS 18001 : 2007

PROFİLİST LED AYDINLATMA SANAYİ VE TİCARET LİMİTED ŞİRKETİ
 Yakuplu Mah. 78. Sok. No:13A/A Beylikdüzü-İstanbul/TÜRKİYE

KAPSAM
 Aydınlatma ekipmanlarının üretim süreci (tasarım, üretim)

AS
 ACCREDITED
 OHSAS 18001:2007



PROFIL LED

www.profilistled.com www.profilistled.ro

OFFICE Charles de Gaulle Plaza, 15 Charles de Gaulle Square, 3 floor, 1 District ,Bucharest, 011886 , Romania.
HEAD QUARTER Beylikdüzü OSB zone, 3rd street , Nr. 8 Floor 4, Corner Office Building Beylikdüzü/İstanbul/Turkey.

Tel: +90 212 536 06 59 +40 31 860 47 25

Mail: info@profilistled.com office@profilistled.ro